



3D Accuitomo

XYZ Slice View Tomograph

INSTRUCTIONS FOR USE



Thank you for purchasing the 3D Accuitomo XYZ Slice View Tomograph.

For optimum safety and performance, read this manual thoroughly before using the unit and pay close attention to the warnings and notes.

Keep this manual in a convenient place for easy reference.

■ Trademarks (™) and Registered Trademarks (®):

The names of companies, products, services, etc. used in this manual are either trademarks or registered trade marks owned by each company.

Table of Contents

	Page
Prevent Accidents	iii
For Safe Operation	v
1. Parts Identification, Warning Labels, and Accessories	1
2. Operation.....	7
Operation Procedure Float Chart	7
Set Up	8
Operation Check	11
[Operation]	12
Patient Seating and Positioning	12
CT Exposure Settings.....	27
No X-ray Setting	30
CT Exposure.....	31
Image Reconstruction	32
Scout Exposure Settings	33
Scout Exposure.....	35
Patient Egress	39
After Use	40
3. Maintenance, Parts Replacement, and Storage.....	42
Maintenance	42
Parts Replacement	42
Storage	42
4. Regular Inspection	43
5. Troubleshooting	45
6. Cautionary Remarks on Imaging	53
7. Technical Description.....	63
Technical Description.....	63
Meaning of Symbols	69
List of Replacement Parts.....	74
8. Appendix – Electromagnetic Declaration.....	75

Prevent Accidents

ATTENTION CUSTOMERS

Do not fail to receive clear instructions concerning the various ways to use this equipment as described in this accompanying Operator's Manual.

To access the warranty information for this product, scan the following QR code and visit our website.



ATTENTION DEALERS

Do not fail to give clear instructions concerning the various ways to use this equipment as described in this accompanying Operator's Manual.

PREVENT ACCIDENTS

Most operation and maintenance problems result from insufficient attention being paid to basic safety precautions and not being able to foresee the possibilities of accidents. Problems and accidents are best avoided by foreseeing the possibility of danger and operating the unit in accordance with the manufacturer's recommendations. First thoroughly read all precautions and instructions pertaining to safety and accident prevention; then, operate the equipment with the utmost caution to prevent either damaging the equipment itself or causing bodily injury.

Note the meaning of the following symbols and expressions:



This warns the user of danger of death, serious bodily injury or total equipment damage and failure or fire.



This alerts the user to the risk of light to medium injury or equipment damage.

Usage Note

This alerts the user of important points concerning operation.

The user (e.g., healthcare facility, clinic, hospital etc.) is responsible for the management, maintenance, and use of medical devices.

Disregarding the information on safety is considered ABNORMAL USE.

Special training is not required for the operation of this equipment. Users are required to read the precautions and instructions pertaining to safety and accident prevention in the Operation Instructions.

INTENDED OPERATOR PROFILE

- a) Qualification:
Legally qualified persons such as radiologists, radiologic technicians, physicians or dentists for X-ray device operation (it may differ among countries).
- b) Education, Knowledge:
Intended for professional use, with a basic knowledge of X-ray hazards and its protection, anatomy and image diagnosis.
- c) Language understanding:
English or German (Intended for professional use as described above), or at least with language skill to understand the instruction for use provided.
- d) Experience:
Experienced Person with operating X-ray devices such as Computed Tomography system, Fluoroscopic X-ray system, panoramic X-ray device etc.

Use this equipment only for diagnosis of small regions within a limited area of hard tissue of the head such as dental or ENT.

Caution: Federal law restricts this device to sale by or on the order of a dentist (for U.S.A.).

THE USEFUL LIFE

- The useful life of the 3D Accuitomo is 10 years (based on self-certification) from the date of shipment provided it is regularly and properly inspected and maintained.
- J. MORITA MFG. CORP. will supply replacement parts and be able to repair the product for a period of 10 years after the manufacture of the product has been discontinued.

For Safe Operation

⚠ WARNING

- *Do not use this unit with patients who have a pacemaker. This equipment could cause a pacemaker to malfunction.*
- *Judgment and caution should be used in regards to radiographs of pregnant women. The decision should be based on “clinical need of diagnostic information”.*
- *Electromagnetic wave interference could cause this device to operate in an abnormal, random and possibly dangerous manner. Cellular and PHS telephones, transceivers, remote controls and all other devices which transmit electromagnetic waves located inside the building should be turned off.*
- *The following devices could cause the equipment to operate in a random manner and should not be located within the X-ray protection area, or be turned off while the equipment is in use.*
 1. *Electrical diagnostic, examination or treatment devices.*
 2. *Personal computers*
- *This equipment must be installed in an X-ray shield location. Local regulation for radiation protection must be observed.*
- *The X-ray protection area should consist of a wall, floor and ceiling with a minimum of 1.5 mm lead shielding or its equivalent and should have glass windows with a minimum of 1.5 mm lead shielding or its equivalent, through which the operator can observe the patient. A sign should clearly identify the area as an X-ray protection area, and a caution sign should light up during X-ray emission. Observe local regulations.*
- *Proper infection control procedures must be established and maintained for each patient.*
- *It is strongly suggested that no unauthorized personnel be in the immediate area when the equipment is in use.*
- *This unit is not designed for and must not be used for “fluoroscopic examinations”.*
- *Proper radiation safety precautions must be established in accordance with local, state and governmental regulations in regards to operator and patient protection. The ultimate responsibility lies with the owner/operator to ensure that the protection requirements of national and local codes are met.*
- *The operator must be able to see the exposure emissions lights and hear the audible signal during operation of the equipment.*
- *The operator must be able to see and hear the patient during the operation of the equipment.*
- *Focal Spot and Skin Distance should be as great as possible to keep the absorbed X-ray dosage as low as reasonably achievable.*
- *It may not be possible to make a diagnostically useful exposure if the patient has metal fillings or prosthetic devices.*
- *Do not use multiple portable socket outlet nor extension cord for the system power supply.*
- *MEDICAL ELECTRICAL EQUIPMENT needs special precautions regarding EMC and needs to be installed and put into service according to the EMC information provided in the ACCOMPANYING DOCUMENTS.*
- *Portable and mobile RF communications equipment can affect MEDICAL ELECTRICAL EQUIPMENT.*
- *Use of parts other than those accompanied or specified by J. MORITA MFG. CORP. may result in increased EMC emissions or decreased EMC immunity of the EQUIPMENT.*
- *The EQUIPMENT should not be used adjacent to or stacked with other equipment and that if adjacent or stacked use is necessary, the EQUIPMENT should be observed to verify normal operation in the configuration in which it will be used.*
- *This equipment must only be operated by doctors, dentists, properly licensed persons and other legally qualified professionals.*
- *Use this equipment only within an X-ray protection area.*
- *Take steps and precautions to prevent entry into the X-ray protection area during X-ray emission.*

⚠ CAUTION

- *There may be ring-shaped artifacts in the reconstructed images caused by unavoidable gain inconsistencies in the photodiode arrays on the flat panel. Please note that these kinds of artifacts may sometimes stand out especially in the area close to the rotation center on the axial slice images and can be an obstacle in diagnosis.*
- *There may be some visible dots or lines on the X-ray images during image acquisition. These lines are caused by unavoidable gain inconsistencies in the flat panel. The presence of these dots and lines does not indicate that the panel is defective.*
- *This equipment is suitably designed for hard tissues such as teeth and bones. It may not be useful for soft tissue diagnosis.*
- *This equipment does not provide CT Numbers (required in 21 CFR 1020.33 and IEC60601-2-44) or any equivalent values calculated from the absolute X-ray absorption of the target material.*
- *The X-ray images could be affected by either constant or intermittent environmental electromagnetic noise. This could cause image distortions or shifts that could render the obtained images useless for diagnosis.*
- *Quality Tests should be performed regularly once every six months (once a month recommended) to maintain the conditions for adequate image performance and X-ray safety of the equipment. The test procedure is described in the Quality Tests Procedure manual that will be provided with the equipment. Other basic functions such as mechanical movements, LCD panel display and Control Panel keys should also be checked each day before use.*
- **CLASS 1 LASER PRODUCT:** *A Class 1 laser is used for the optical interface.*
- *To use the X-ray head assembly under appropriate loading conditions, leave an interval of approximately 5 minutes for each irradiation and leave an additional 15 minutes after every 3 irradiations.*
- *The rotating green circle also works as the READY key. Be cautious of the arm rotation as it returns to the ready position when you touch this green circle.*

Safety and Accident Prevention for the Operation of Electrical Medical Devices

1. Only fully trained and qualified personnel may operate equipment.
2. Items to be duly noted when installing equipment.
 - 1) Locate the unit in a place where it will not get wet.
 - 2) Install the unit in a location where it will not be damaged by air pressure, temperature, humidity, direct sunlight, dust, salts, or sulfur compounds.
 - 3) The unit should not be subjected to tilting, excessive vibrations, or shocks (including during shipping and handling).
 - 4) Do not install the unit where chemicals are stored or where gas may be released.
 - 5) Follow all electrical specifications including frequency (Hz), voltage (V), and current capacity (A) (power consumption).
 - 6) The equipment must be properly grounded.
(Everything which requires a large power supply such as X-ray units, chairs, air compressors etc. must have a three point power connection.)
3. Item to be duly noted before use.
 - 1) Inspect all switch connections, polarity, dial settings, meters etc. to confirm that the equipment will operate properly.
 - 2) Confirm that the ground is connected properly.
 - 3) Confirm that all cords are connected properly.
 - 4) Take into consideration that simultaneous use of more than one instrument or device can create a dangerous situation or lead to a mistake in diagnosis.
 - 5) Reconfirm the safety of external circuits or systems which are connected directly to the patient.
4. Item to be duly noted during use.
 - 1) Do not exceed volumes or times necessary for the diagnosis or treatment.
 - 2) Maintain a constant vigilance for abnormal conditions in both the equipment and the patient.
 - 3) Appropriate steps, such as shutting the equipment down, should be devised to protect the safety of the patient in case any abnormalities in the equipment or the patient are observed.
 - 4) Make sure the patient does not handle or manipulate the equipment.
5. Item to be duly noted after use.
 - 1) Turn the power off after returning dials, switches etc. back to their original positions in the prescribed order.
 - 2) Do not use excessive force or pull the cord itself to disconnect cords.
 - 3) The following items should be considered when storing the equipment:
 - a. The storage area should protect the equipment from getting wet.
 - b. The storage area should protect the equipment from any possible damage due to atmospheric pressure, temperature, humidity, wind, direct sunlight, dust or air containing salts or sulfur.
 - c. The equipment should be protected from tilting, vibrations, percussive shocks, etc. (including when it is being moved).
 - d. The storage area should be free of chemicals and gases.
 - 4) All accessories, cords, guides etc. should be cleaned, properly arranged and carefully put away.
 - 5) Before storage, the equipment should be cleaned so that it is ready to be used again.
6. In case of a malfunction or defect, operators should attach a written notice indicating that the equipment is out of order without attempting to repair the equipment themselves; repairs should be referred to a qualified serviceman.
7. Equipment should not be modified in any way.
8. Maintenance and Inspection.
 - 1) All equipment and components should be inspected regularly.
 - 2) Equipment which has not been used recently should always be inspected to confirm that it functions properly and safely before being put back into use.

1. Parts Identification, Warning Labels, and Accessories

Main Unit

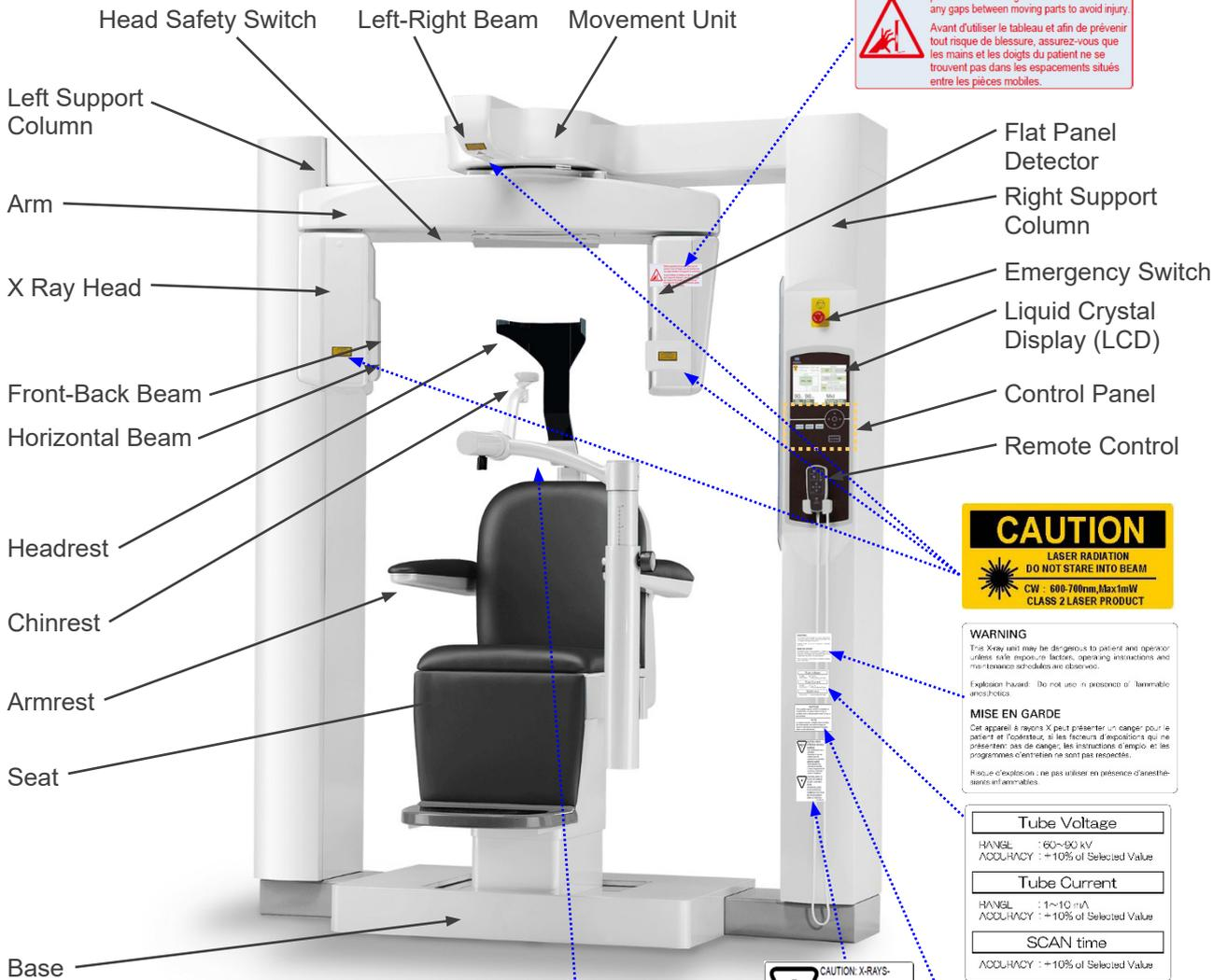

Lower, Rear of Left Support Column



Control Box

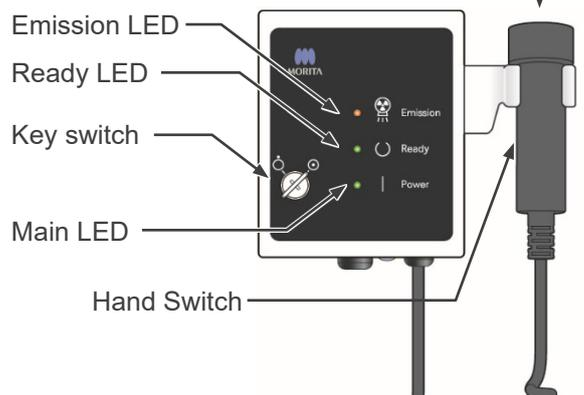

Liquid Crystal Display (LCD)

Main Settings Display

- Touch the display screen directly to set conditions. (The color of a key will change when it is pressed.)

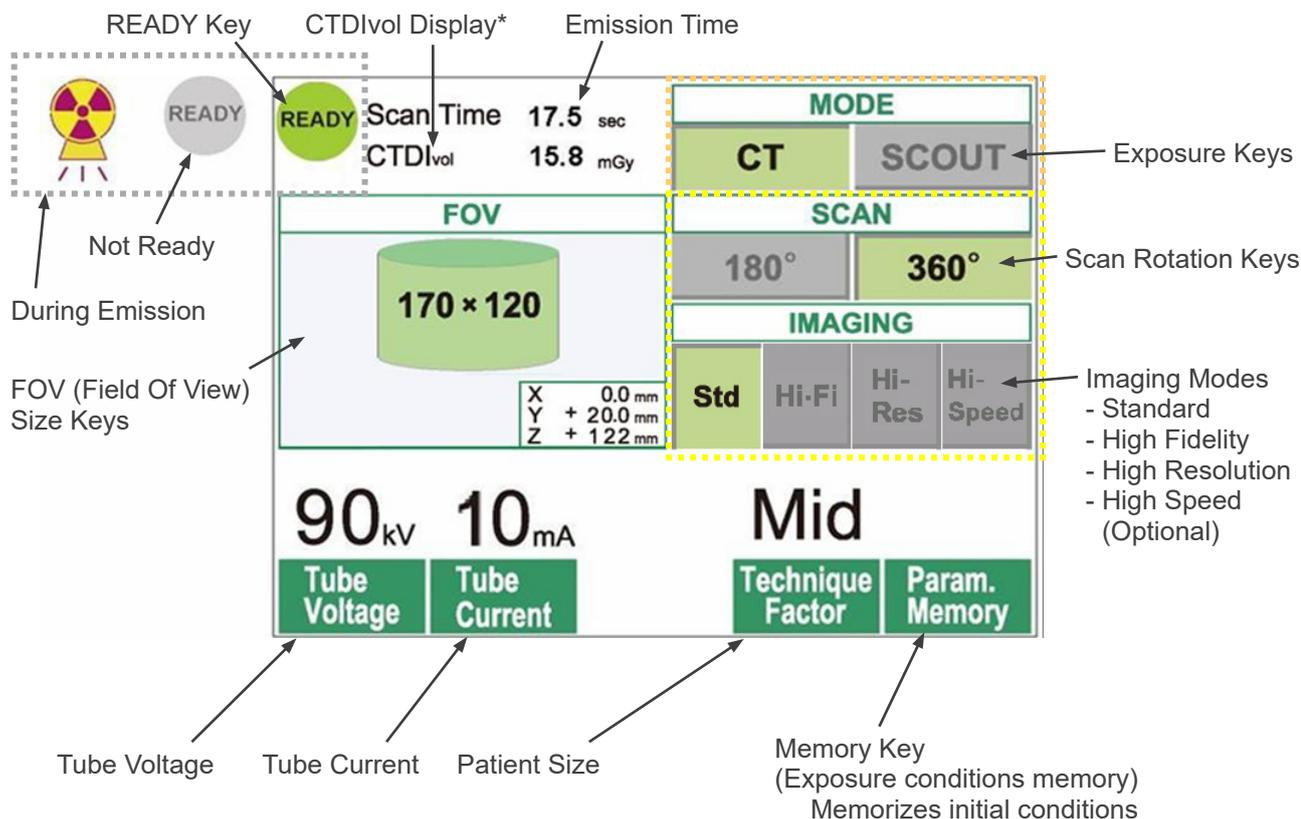

* CTDI_{vol} (Volume CT Dose Index): Standard index for X-ray exposure
 Unit: mGy. Until recently, CT radiography used the index CTDI_w (Weighted CT Dose Index) for a single rotation. However, in order to accommodate helical CT and MDCT, CTDI_{vol} is now used for one entire exposure sequence. For this MCT-1 F17 unit, CTDI_{vol} and CTDI_w have the same value.

Usage Note

- **Gently touch on the display screen by a finger. Do not press too much or poke with a stick such as a ball-point pen. The glass may break and may cause an electrical shock.**

* Scout settings display



The display shows the current settings, gives instructions, and may display an error message.

Settings Display

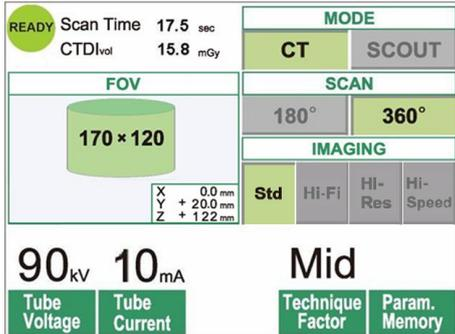

Example
Select either CT or Scout scan.

Instructions

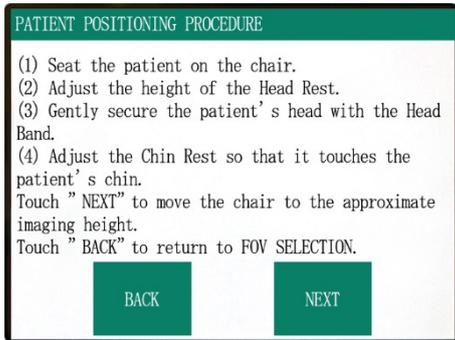

Example
Instruction are displayed.

Error Message

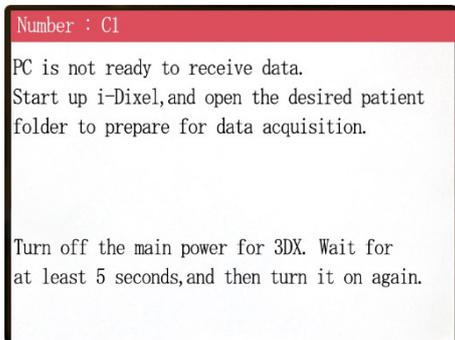

Example
Error message appears in display.

Control Panel

BEAM On / Off Key

Turn on/off the beams.

READY Key

Returns arm to start position.

Patient IN / OUT Key

Move arm to position for patients to get in or out of chair.

Arm LOCK / FREE Key

Locks the arm in position or frees it.

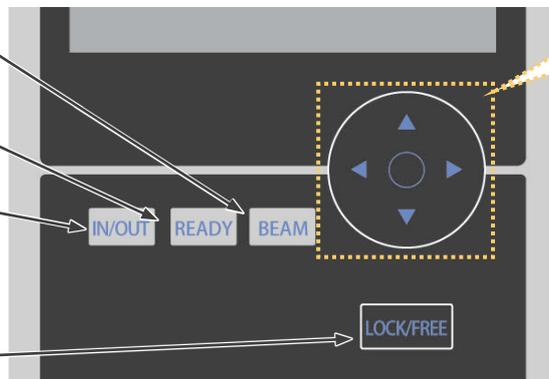

For maintenance only;
not normally used.

Remote Control

HEAD REST Keys

Move headrest up or down.

Chair Forward / Backward Keys

Move chair frontwards or backwards.

Chair Up / Down Keys

Move chair up or down.

Chair Left / Right Keys

Move chair left or right.

POSITION MEMORY Key

Hold this key down for 3 seconds to memorize the chair's current position. After that, the chair will move to the memorized position whenever this key is pressed.

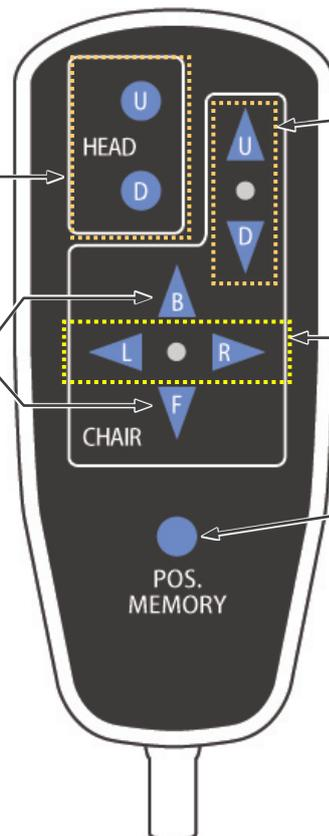

Emergency Switch

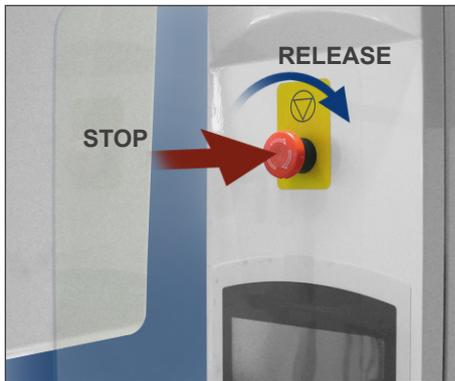

Emergency Stop Distances

(distance traveled after switch is pressed)

Arm	10 mm (at side of head cover)
Chair Vertical	5 mm
Chair Horizontal	5 mm

⚠ WARNING

- ***In case of an emergency, press the emergency switch and have the patient get out of the chair immediately.***

In an emergency, press the emergency switch. The chair and arm will stop moving, and X-ray emission will also stop.

⚠ CAUTION

- ***If the Emergency Switch or Head Safety Switch is pressed during exposure, the image being acquired will be lost.***

After Pressing Emergency Switch

Have the patient move away from the unit, and turn off the Main switch.

Restore normal, safe operation in the following way. Rotate the emergency switch in the direction shown by the arrow in the illustration above. Restart the computer. Turn the Main switch back on. Check the unit operates normally and safely. If the unit is not restored to normal, safe operation, contact your local dealer or J. MORITA CORP.

Head Safety Switch

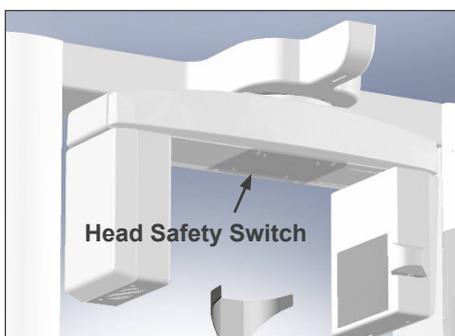

The Head Safety Switch is activated if the patient's head touches the arm because the chair is raised too high or the patient stands up. The chair, arm and x ray emission will all stop. Turn off the Main switch and move the patient away from the unit. To repeat the exposure procedure, turn the Main switch back on and make sure the unit operates normally and safely. If the unit is not restored to normal, safe operation, contact your local dealer or J. MORITA CORP.

⚠ CAUTION

- ***Take care that nothing like a piece of cloth used for cleaning gets in the gap between the safety switch and the arm. This could disable the safety switch.***

Accessories

- a. Head Band (A) (2)
- b. Headrest Cushions (small) (2)
- c. Head Band (B) (1)
- d. Headrest Cushions (large) (2)
- e. Child Seat (1)
- f. Support Seat (2)
- g. Chinrest (1)

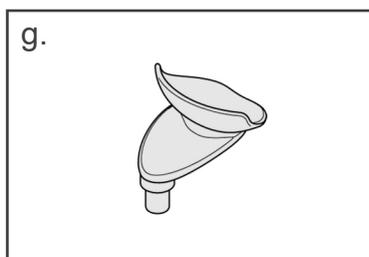
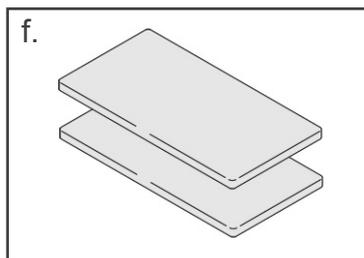
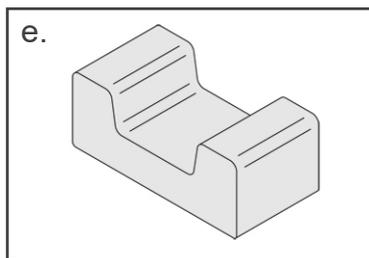
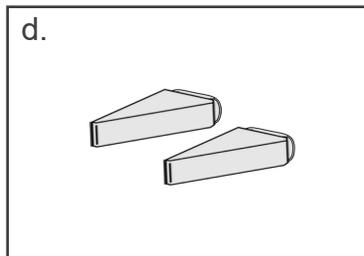
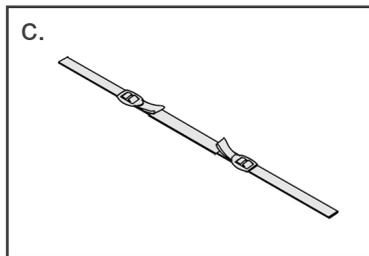
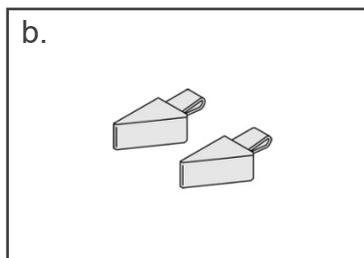
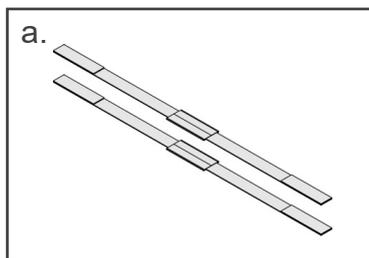

2. Operation

Operation Procedure Float Chart

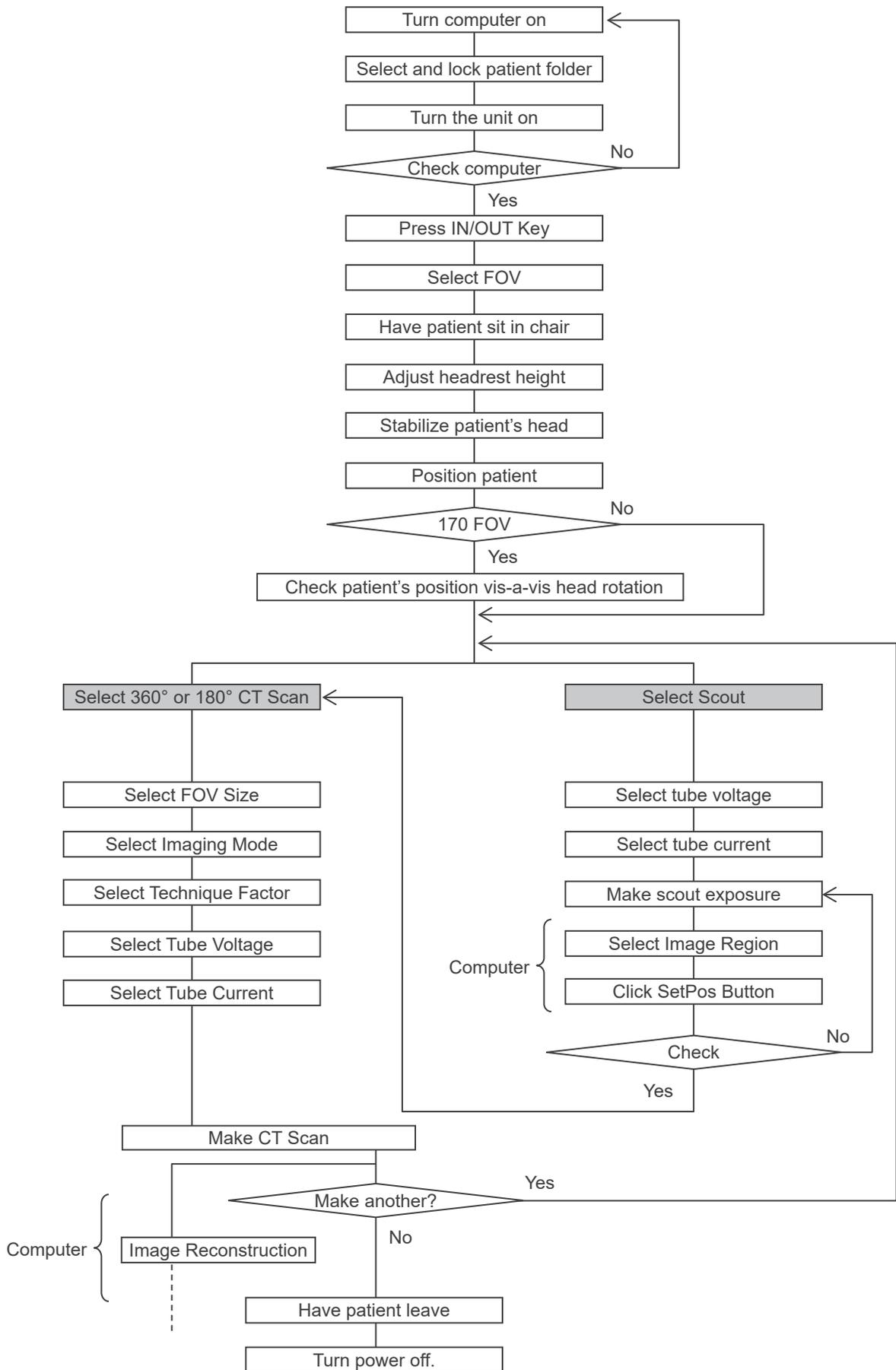

Set Up

* Operating Environments

Temperature: +10°C to +30°C (+50°F to +86°F)

Humidity: 30% to 75% (without condensation)

Atmospheric Pressure: 70 kPa to 106 kPa.

- * If an accident occurs, the equipment must not be used until repairs have been completed by a qualified and trained technician provided by the manufacturer.
- * Have the patient remove glasses, necklaces, earrings and other accessories which could interfere with diagnosis.
- * If the unit has not been used for some time, make sure it operates normally and safely before actually using it.

Turn Computer On

Turn the computer on.

Startup the i-Dixel software. Select a patient folder from the database or make a new folder.

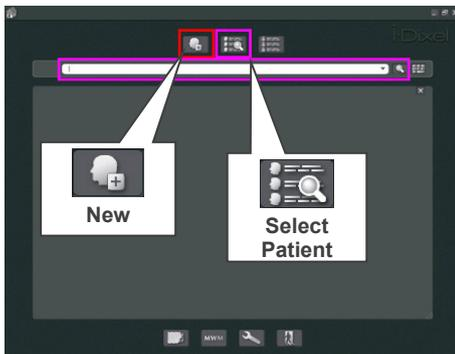

Choose a patient folder to data read-in.



- * For details refer to the instructions for the i-Dixel application.

- * If the computer is not on or not ready to receive image data, the following error message will appear in the unit's LCD:

“PC is not ready to receive data.

Start up i-Dixel, and open the desired patient folder to prepare for data acquisition.

Turn main power off, wait for 5 seconds.

Turn power back on on again.”

Turn the Unit On

Turn on the Main switch, which is located on the lower back of the left support column.

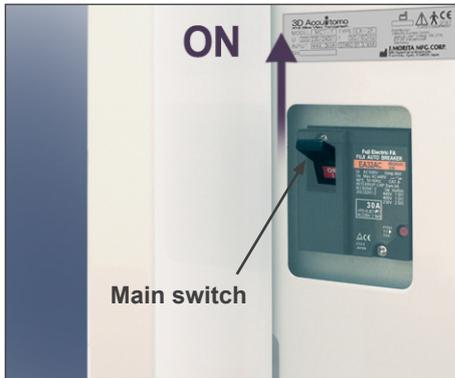

The Main LED on the control box will light up, and the message, "Checking communication with the Application Software running on the destination PC." After confirming normal communication with the computer, the unit will display the message, "Press "IN/OUT" key on the control panel."

LCD Message

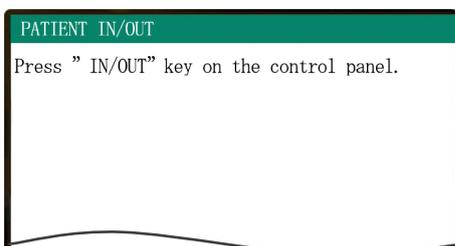
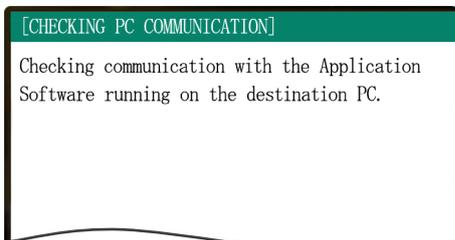
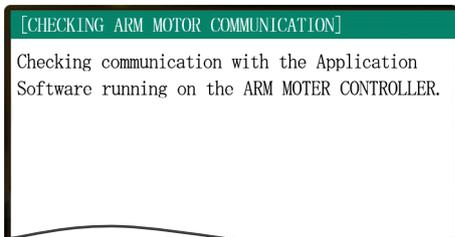

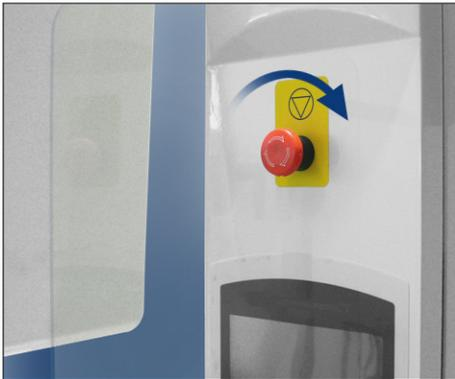

Usage Note

- *If the Emergency Switch is accidentally pressed during cleaning or for some other reason, it must be reset by turning it in the direction indicated by the arrow in the illustration before the unit will operate.*



Check that only the operator is in the vicinity of the equipment and press the IN/OUT key. "CHAIR IS IN MOTION" will appear in the LCD and the seat and arm will move into position to receive the patient.



⚠ WARNING

- *Before pressing the In / Out Key, make sure the chinrest is in the closed position, the position where it can be used by the patient; otherwise, the arm might hit it causing damage or an injury.*

⚠ CAUTION

- *Both the arm and chair move so make sure there are no obstacles or body parts (fingers, toes etc.) under the step or otherwise in the way.*
- *If the control panel, LCD, remote control or other switches stop working (freeze) for some reason, guide the patient away from the chair and turn the power off. Wait about 5 seconds and then turn the power back on.*

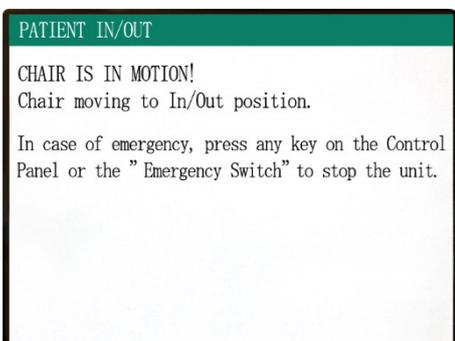

Operation Check

Before operating this unit, check the following items.

- Turn the main switch on and press In / Out key. Check that the arm and the chair automatically move into the patient entry position.
- Set the exposure conditions and hold down the emission button. Check that the arm rotates, X-rays are emitted and the buzzer sounds.
- Release the emission button and check that the X-ray emission and arm rotation is terminated immediately and also the buzzer stops.
- * Move the chinrest arm to the position where it is used by the patient, and adjust it to its lowest position.

[Operation]

⚠ WARNING

- **In case of electrical storms, immediately let the patient out of the unit and turn off the mains power to avoid an electric shock, fire or system damage caused by power surges. Do not touch the main unit, Control Box, computer, optical receiver or cables.**

Patient Seating and Positioning

⚠ WARNING

- **If you decide to switch patients, start the procedure for seating and positioning from the very beginning. Otherwise, the image might not come out right, or the arm might hit the patient.**

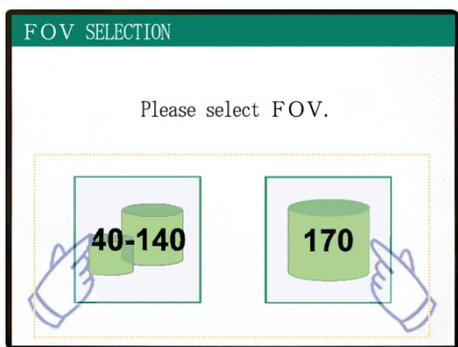

Select FOV (Field of View).

- * Press the 40–140 FOV key to select the 40×40, 60×60, 80×80, 100×50, 100×100, 140×50 or 140×100.

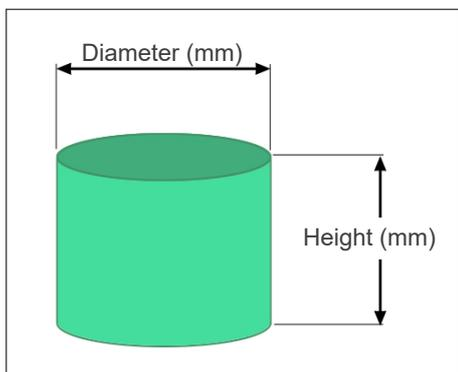

Five FOVs (Fields of View)

Diameter (mm)	Height (mm)
40	40
60	60
80 *	80 *
100 *	50 *
100 *	100 *
140 *	50 *
140 *	100 *
170 *	50 *
170 *	120 *

* Not available for High Resolution and High Speed modes (Optional)

⚠ WARNING

- *Chose as small an imaging area as possible to minimize the absorbed X-ray dosage.*

⚠ CAUTION

- *The Flat Panel Detector has two positions: one for 40–140 FOV and another for the 170 FOV. Therefore, it may move when the FOV is selected. In this case, a message will appear in the LCD. Take appropriate safety steps.*

For 40–140 FOVs

- * Select the 170 FOV.
Selecting 170 is done later (page 28).

Select 40–140 FOV.

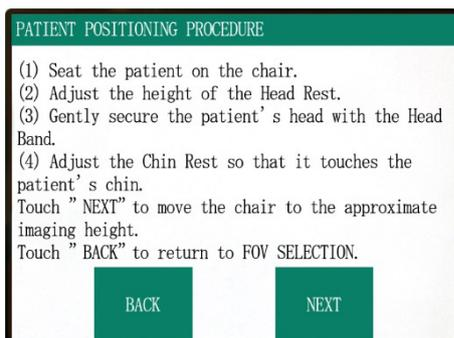
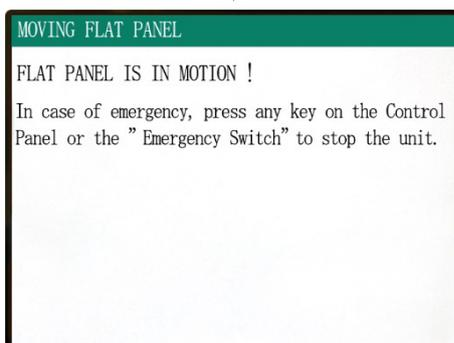
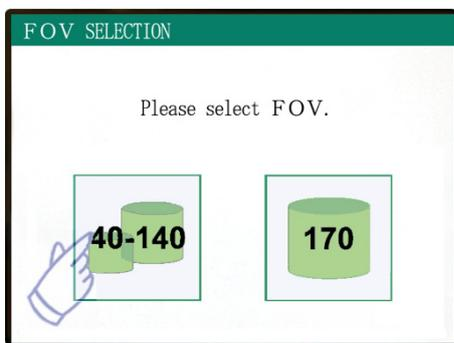

The patient seating procedure will appear in the control panel's LCD.

Patient Seating

(1) Seat the patient on the chair.

Have the patient put on X-ray protection gear and sit down.



⚠ WARNING

- **The patient must be provided with appropriate X-ray protection gear such as lead-impregnated clothing that conforms to local regulations.**

First adjust Chinrest to its lowest position, and then open the Chinrest arm to allow the patient to enter.



⚠ WARNING

- **Avoid pinching body parts; wait until everything stops moving before have the patient sit in or get out of the chair.**
- **Make sure no body parts are pinched by moving parts. Watch the area between the arm and support columns, the headrest, the chinrest, the slide mechanism for the flat panel detector and under the foot step.**



⚠ CAUTION

- **Keep an eye on the patient and the equipment when it is moving. In case of an emergency, stop the equipment by pressing any key on the remote control except the position memory key. (Keys in the display cannot be used to stop the chair in an emergency.)**
- **Always try to maintain contact with the patient visually and auditorily to ensure safe operation of the unit.**

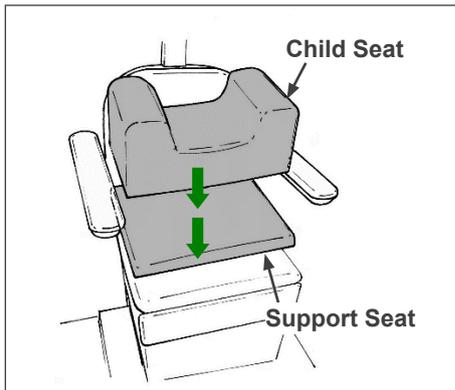

- * Use the auxiliary seats if the patient's head does not reach the headrest.

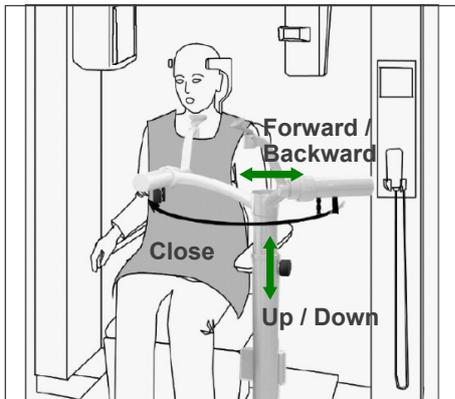

After the patient sits down, swing the chinrest in front of him/her. Be careful not to hit the patient with it.

The chinrest can be moved up or down and backwards and forwards to line up with the patients chin.

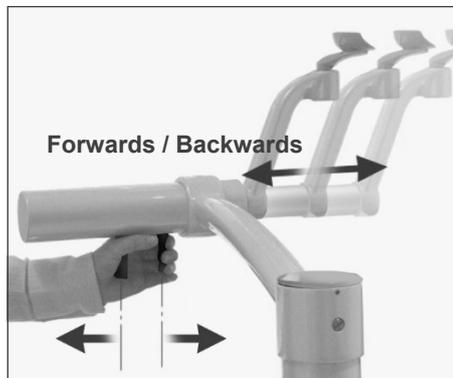
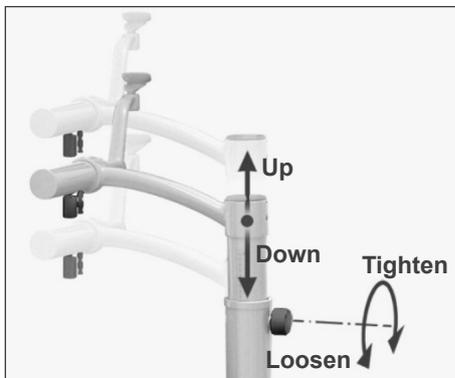

⚠ WARNING

- **If both the chair and the chinrest are too high, the arm could hit the chinrest. Before making an exposure, press the Lock / Free key to free the arm and then carefully rotate it manually to make sure it will not hit the chinrest.**
- **Do not lean on or put excessive weight on the chinrest. It may be damaged which may result in injury.**
- **Take care not to injure the patient when adjusting the chinrest.**

⚠ CAUTION

- **Take care not to pinch your fingers or the patient's fingers in the chinrest's slide mechanism, knobs, or other moving parts.**
- **Never try to move the arm when it is locked; this could damage it and will cause an error message to appear.**
- **Even when the arm is free, rotate it carefully, slowly, and safely.**

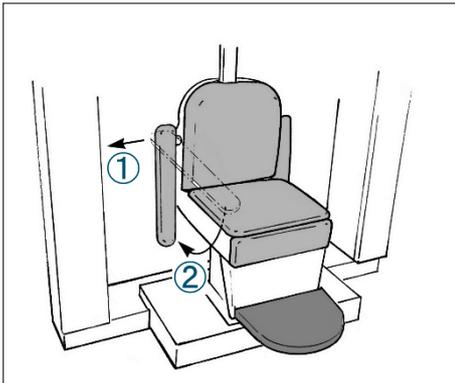

* If the armrest is in the way, pull it out slightly and then lower it.

⚠ CAUTION

- *After the patient sits down, do not fail to raise the armrest back up.*

Proper Seated Position



Hands on armrests
Feet in center of step

Seated Position

Have the patient sit all the way back in the chair with his/her head up against the headrest, hands on both armrests to prevent scrunching up of his/her shoulders, and feet together in the center of the step.

Before Moving the Chair

Tell the patient you are going to move the chair.

While Chair is in Motion

Make sure patient's hands and feet are properly positioned.

⚠ WARNING

- *Have the patient place his/her hands on the armrests. Do not allow him/her to touch the other parts of the equipment, such as the arm, headrest, chinrest, support columns, control panel, or remote control.*

Children

If necessary, use one or both auxiliary seats for children. Make sure they are sitting in the right position.

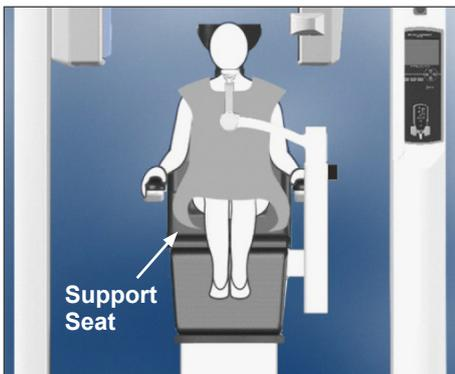

Hands on armrests
With auxiliary seat

⚠ WARNING

- *When using an auxiliary seat, tell the patient not to move or wiggle. The seat could slide or slip and cause an injury.*

(2) Adjust the height of the Head Rest.

Use the headrest keys on the remote control to adjust its height.

(The lower edges or the sides of the headrest should generally be about 2 cm above the ears.)

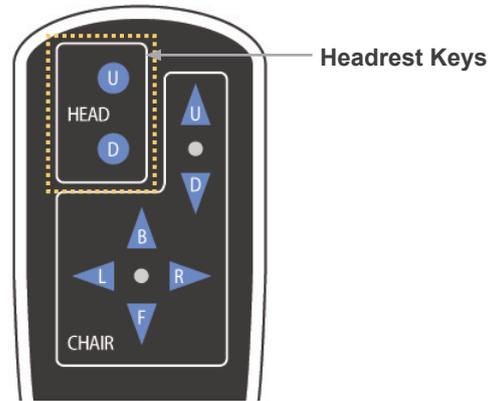
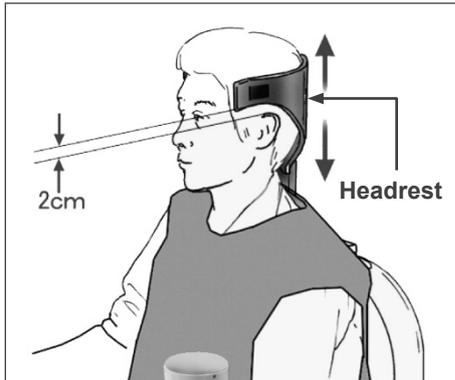

(3) Gently secure the patient's head with the Head Band.

Fix the head band on with the Velcro tape; don't make it too tight.

Put the 2 cushions on the head band and position them against the temples as shown in the illustration.

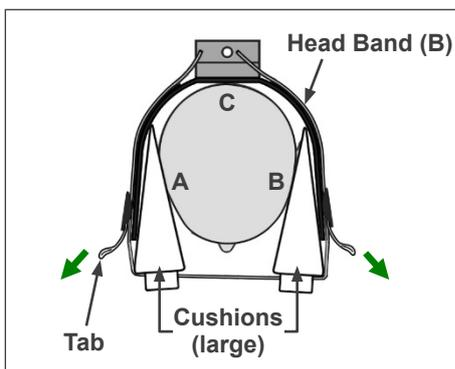
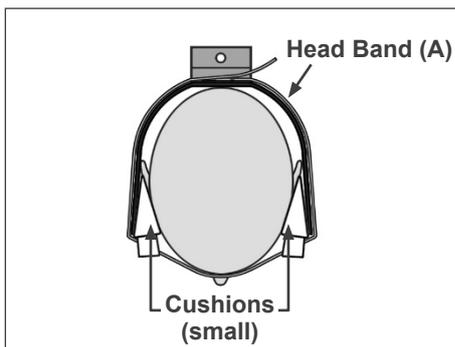
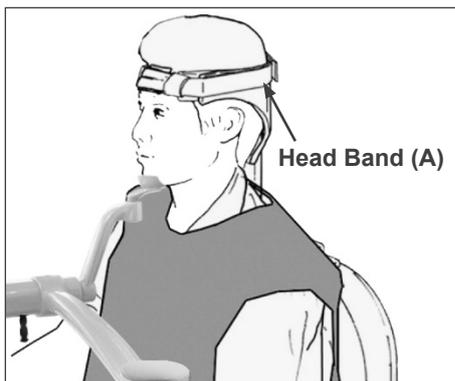

After putting on the child's head band, pull on the tabs to tighten it up so that there is firm contact at points A, B, and C in the illustration.

(4) Adjust the Chin Rest so that it touches the patient's chin.

Adjust the position of the chinrest and have the patient lightly rest his/her chin on it.

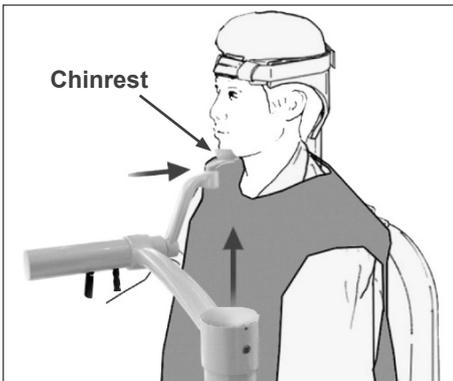

⚠ WARNING

- **Never move the headrest after adjusting the head band or chinrest. It may result in injury to the patient.**
- **Do not lean on or put excessive weight on the chinrest. It may be damaged which may result in injury.**
- **Adjust the chinrest carefully without injuring the patient.**

⚠ CAUTION

- **Take care not to pinch your fingers or the patient's fingers in the chinrest's slide mechanism, knobs, or other moving parts.**

Press Next. A message will appear and the chair will move to the approximate imaging position. Then the next steps in the positioning procedure will appear in the display.

PATIENT POSITIONING PROCEDURE

(1) Seat the patient on the chair.
(2) Adjust the height of the Head Rest.
(3) Gently secure the patient's head with the Head Band.
(4) Adjust the Chin Rest so that it touches the patient's chin.
Touch "NEXT" to move the chair to the approximate imaging height.
Touch "BACK" to return to FOV SELECTION.

BACK NEXT



MOVING TO IMAGING HEIGHT

Chair moving to approximate imaging height.
In case of emergency, press any key on the Control Panel or the "Emergency Switch" to stop the unit.



POSITIONING PROCEDURE

Move the Chair with the Remote Control to:
(1) Adjust the chair height to set the Horizontal beam at the region of interest.
(2) Adjust the chair position to set the Front-Back beam at the region of interest.
Touch "NEXT". The current chair position is saved.

NEXT

⚠ WARNING

- **The arm and chair will move. In case of an emergency press the emergency switch, any key on the control panel or any key on the remote control except the position memory key. (Keys in the display cannot be used to stop the arm and chair in an emergency.)**

(* Refer to page 11 for how to restore normal working order after pressing the emergency switch. If you stopped the unit by pressing some other key, press the Ready key to restore normal operation.)

Patient Positioning

⚠ WARNING

- **CLASS 2 LASER PRODUCT: A Class 2 laser is used for the positioning beams. Do not stare into the positioning beams. Warn the patient not to look at the positioning beams.**

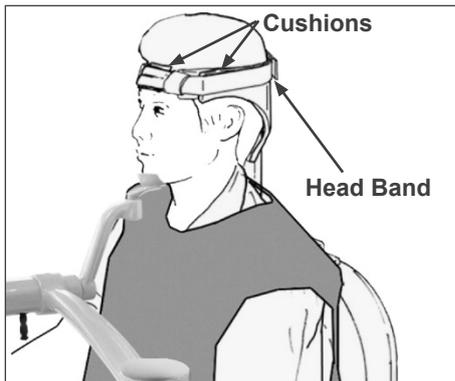

Have the patient rest the back of his/her head straight against the center of the headrest, pull in his/her chin, and straighten his/her back as much as possible. The patient's Frankfort plane should be parallel to the floor, and the Left-Right beam should be lined up with the patient's mid-sagittal plane. Tighten up the head band and make sure the patient's head is sufficiently stabilized.

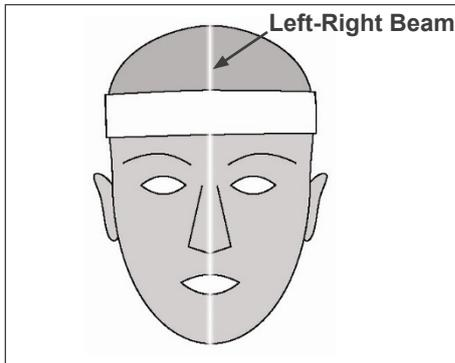

- * If the Left-Right beam will not line up with the patient's mid-sagittal plane, adjust the cushions until it does.

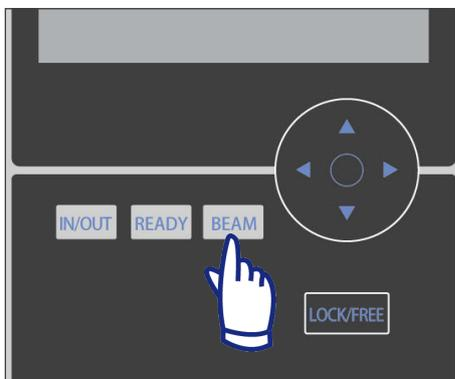

- * The beams turn off automatically after 1 minute. Press the Beam Key on the control panel to turn them back on.



Adjust the chinrest so that the patient's chin rests easily on it. Check that the patient's head is stabilized by the chinrest.

⚠ WARNING

- **Do not lean on or put excessive weight on the chinrest. It may be damaged which may result in injury.**
- **Adjust the chinrest carefully without injuring the patient.**

⚠ CAUTION

- **Take care not to pinch your fingers or the patient's fingers in the chinrest's slide mechanism, knobs, or other moving parts.**

(1) Adjust the chair height to set the Horizontal beam at the region of interest.

Use the keys on the remote control so that the lines up with the center of the imaging area.

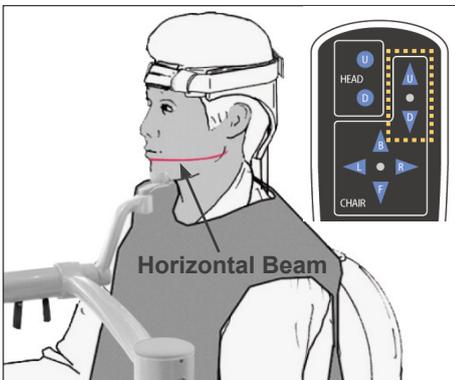

⚠ WARNING

- **Never move the headrest after adjusting the head band and chinrest. It may result in injury to the patient.**

(2) Adjust the chair position to set the Front-Back beam at the region of interest.

Use the keys on the remote control to move the chair so that the Front-Back beam lines up with center of the imaging area.

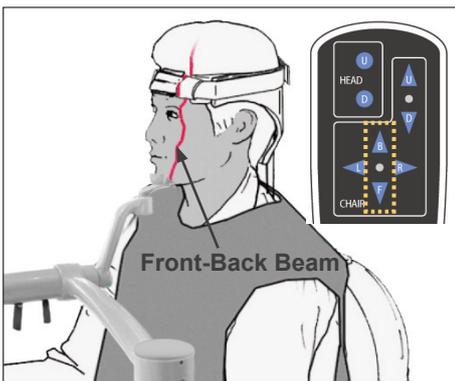

Usage Note

- **The final imaging position must be reconfirmed visually by the positioning beams before exposure. (Do not rely only on scout positioning or the information on the display).**

POSITIONING PROCEDURE

Move the Chair with the Remote Control to:

- (1) Adjust the chair height to set the Horizontal beam at the region of interest.
- (2) Adjust the chair position to set the Front-Back beam at the region of interest.

Touch "NEXT". The current chair position is saved.

NEXT

Press Next. The chair position will be memorized and the Ready LED on the control box will light up. The main settings display will appear in the control panel.

Main Settings Display

READY Scan Time 1.0 sec

MODE
CT SCOUT

FOV
140×100

X 0.0 mm
Y +20.0 mm
Z +122 mm

SCAN
180° 360°

IMAGING
Std Hi-Fi Hi-Res Hi-Spd

80 kV **2.0** mA
Tube Voltage Tube Current

Param. Memory

Press "CT" to make a CT image.
Press "Scout" to make a scout image. (See page 40)

READY Scan Time 17.5 sec
CTD_{vol} 8.8 mGy

MODE
CT SCOUT

FOV
100×100

X 0.0 mm
Y +20.0 mm
Z +122 mm

SCAN
180° 360°

IMAGING
Std Hi-Fi Hi-Res Hi-Speed

90 kV **5.0** mA
Tube Voltage Tube Current

Mid
Technique Factor Param. Memory

For FOV 170×120 Exposures

Select FOV 170.

- * Except for selecting "170", the part of patient seating procedure is the same as for FOV 40–140. Follow procedures for FOV 40–140 (pages 19–24).

⚠ CAUTION

- *In High Resolution and High Speed modes (optional), only 40×40 FOV and 60×60 FOV are available.*

⚠ WARNING

- *The arm and chair will move. In case of an emergency press the emergency switch, any key on the control panel or any key on the remote control except the position memory key. (Keys in the display cannot be used to stop the arm and chair in an emergency.)*

- (* Refer to page 11 for how to restore normal working order after pressing the emergency switch. If you stopped the unit by pressing some other key, press the Ready key to restore normal operation.)

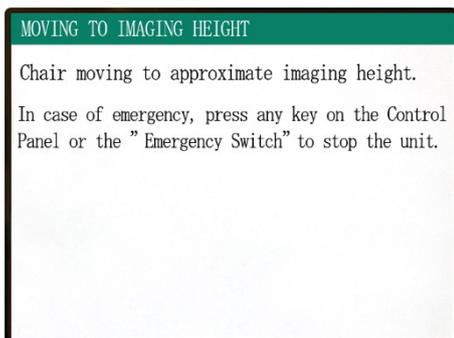
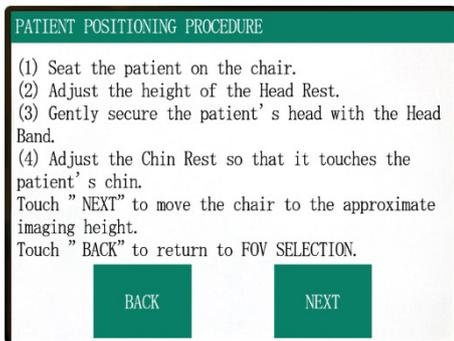
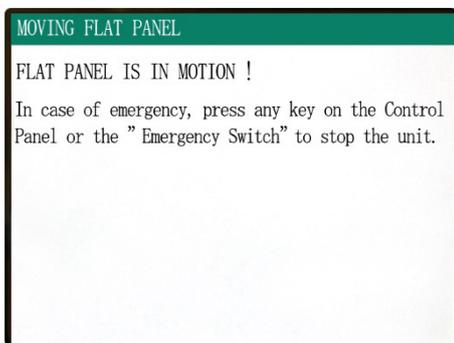
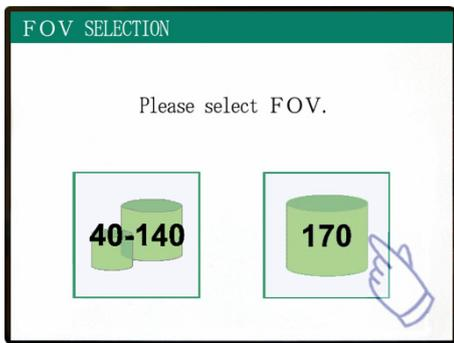



POSITIONING PROCEDURE

Move the Chair with the Remote Control to:

- (1) Adjust the chair height to set the Horizontal beam at the region of interest.
- (2) Adjust the chair position to set the Front-Back beam at the region of interest.

Touch "NEXT". The current chair position is saved.

NEXT

Patient Positioning

- (1) Adjust the chair height to set the Horizontal beam at the region of interest.

Use the keys on the remote control so that the lines up with the center of the imaging area.

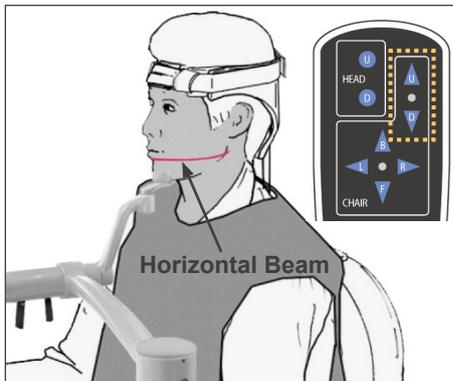

⚠ WARNING

- **Never move the headrest after adjusting the head band and chinrest. It may result in injury to the patient.**

- (2) Adjust the chair position to set the Front-Back beam at the region of interest.

Use the keys on the remote control to move the chair so that the Front-Back beam lines up with center of the imaging area.

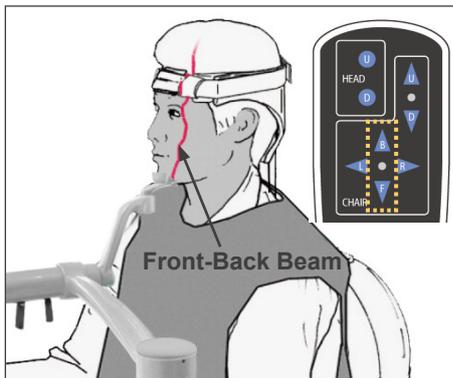

Usage Note

- **The final imaging position must be reconfirmed visually by the positioning beams before exposure. (Do not rely only on scout positioning or the information on the display).**

POSITIONING PROCEDURE

Move the Chair with the Remote Control to:

- (1) Adjust the chair height to set the Horizontal beam at the region of interest.
- (2) Adjust the chair position to set the Front-Back beam at the region of interest.

Touch "NEXT". The current chair position is saved.

NEXT



COLLISION CHECK

Ensure the Flat Panel does not come into contact with the patient or other parts of the equipment during rotation.

- (1) Slowly rotate the Rotation Arm manually.
- (2) Check that the Flat Panel does not contact the patient's shoulder, the chin-rest or the head-rest during rotation.
- (3) If it does, try lowering the chair as far as imaging requirement permits.
- (4) If it still hits something, this FOV cannot be used. Press the "IN/OUT" key to select a smaller FOV.

Touch "NEXT" to proceed.

NEXT

Ensure the patient positioning and press "Next"

Free the arm and rotate it carefully so that the arm does not hit the patient.

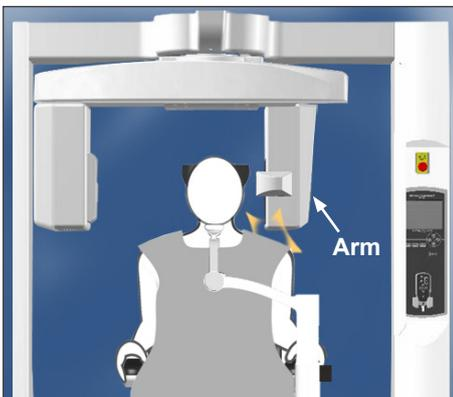

Check Patient Positioning

(1) Slowly rotate the Rotation Arm manually.

(2) Check that the Flat Panel does not contact the patient's shoulder, the chin-rest or the head-rest during rotation.

Do this carefully so that the arm does not hit the patient.
Free the arm and rotated it manually.

* The arm might hit something so rotate it slowly and carefully.

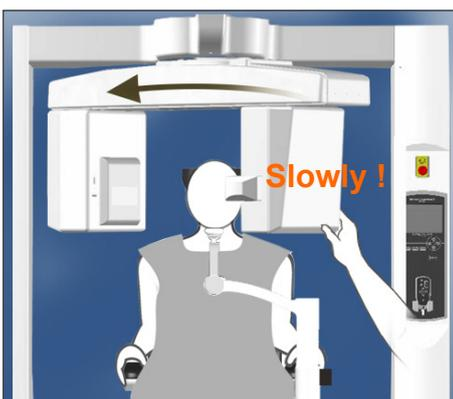

If the arm hits something use the remote control key to adjust the chair height, or press the In / Out key and select a different FOV.

⚠ CAUTION

- **Never try to move the arm when it is locked; this could damage it and will cause an error message to appear.**
- **Even when the arm is free, rotate it carefully, slowly, and safely.**

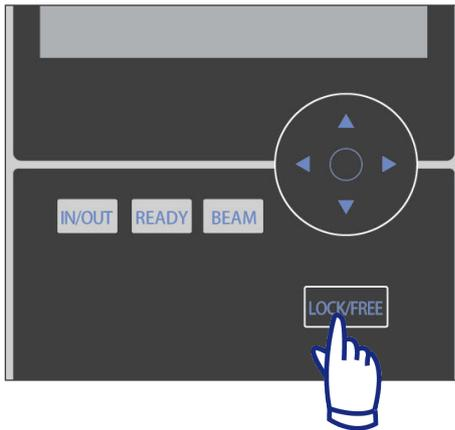

Usage Note

- To lock the arm, press the Lock / Free key while the arm is standing still. Press the same key again to free the arm.
- To put the unit into Ready mode when the arm is free, press the Ready key while the arm is standing still.

(3) If it does, try lowering the chair as far as imaging requirement permits.

Adjust the height of the chair with the Up / Down keys on the remote control so that the arm will not hit the patient.

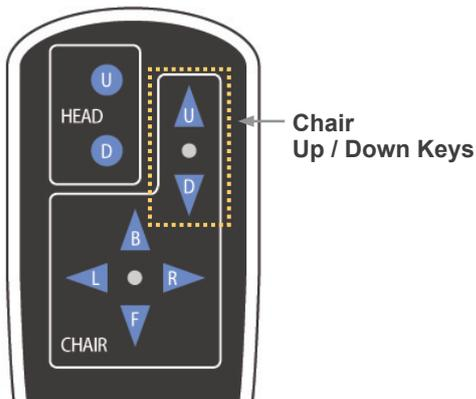

(4) If it still hits something, this FOV cannot be used. Press the "IN/OUT" key to select a smaller FOV.

If proper adjustment is troublesome or not possible, press the In / Out key and select a different FOV.

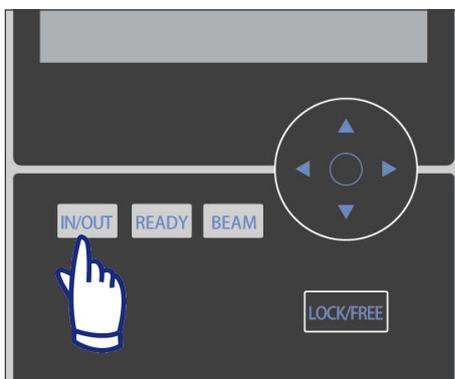

⚠ CAUTION

- Watch out for the chair's movement when you press the In / Out key to select a different FOV.

COLLISION CHECK

Ensure the Flat Panel does not come into contact with the patient or other parts of the equipment during rotation.

- (1) Slowly rotate the Rotation Arm manually.
- (2) Check that the Flat Panel does not contact the patient's shoulder, the chin-rest or the head-rest during rotation.
- (3) If it does, try lowering the chair as far as imaging requirement permits.
- (4) If it still hits something, the FOV cannot be used. Press the "IN/OUT" key to select a smaller FOV.

Touch "NEXT" to proceed.

NEXT

Press Next. The chair position will be memorized and the Ready LED on the control box will light up. The main settings display will appear in the control panel.

ARM ROTATING!

The ARM has been returned to the ready position.



Main Settings Display

READY Scan Time 1.0 sec

MODE
CT SCOUT

FOV
170x120

X 0.0 mm
Y +20.0 mm
Z +122 mm

SCAN
180° 360°

IMAGING
Std Hi-Fi Hi-Res Hi-Spd

80 kV **2.0** mA
Tube Voltage Tube Current Param. Memory

Press "CT" to make a CT image.
Press "Scout" to make a scout image. (See page 40)



READY Scan Time 17.5 sec
CTD_{vol} 8.5 mGy

MODE
CT SCOUT

FOV
170x120

X 0.0 mm
Y +20.0 mm
Z +122 mm

SCAN
180° 360°

IMAGING
Std Hi-Fi Hi-Res Hi-Speed

90 kV **5.0** mA
Tube Voltage Tube Current Technique Factor Param. Memory

CT Exposure Settings

The diagram shows a control panel for CT exposure settings. At the top left, it displays 'READY', 'Scan Time 17.5 sec', and 'CTDI_{vol} 8.5 mGy'. Below this is the 'FOV' section with a cylinder icon labeled '170 x 120' and a table of coordinates: X: 0.0 mm, Y: + 20.0 mm, Z: + 122 mm. The main control area is divided into several sections: 'MODE' with 'CT' and 'SCOUT' buttons; 'SCAN' with '180°' and '360°' buttons; 'IMAGING' with 'Std', 'Hi-Fi', 'Hi-Res', and 'Hi-Speed' buttons; and a bottom section with '90_{kV}' and '5.0_{mA}' (labeled 'Tube Voltage' and 'Tube Current'), and 'Mid' (labeled 'Technique Factor' and 'Param. Memory').

Numbered callouts point to the following elements:

1. Select CT exposure (points to the CT button in the MODE section)
2. Select scan rotation (180°/ 360°) (points to the 360° button in the SCAN section)
3. Imaging Modes * (points to the Std, Hi-Fi, Hi-Res, and Hi-Speed buttons in the IMAGING section)
4. Select Preset Technique Factor (points to the Mid button in the bottom section)
5. Set Tube Voltage (points to the 90_{kV} display)
6. Set Tube Current (points to the 5.0_{mA} display)
7. Memory Key (Exposure conditions memory. Sets initial conditions when unit is turned on.) (points to the Param. Memory button)

- * Touch the display screen directly to set conditions. (The color of a key will change when it is pressed.)
- * High Fidelity, High Resolution and High Speed modes are optional.

⚠ WARNING

- ***If the X-rays are too strong and pass through some material such as air that has very low absorption, the detector in that area will be saturated. In the resulting image, the saturated area may falsely appear to entirely lack any tissue whatsoever. To make an accurate diagnosis, one should carefully watch the image produced during the exposure to identify saturation areas.***

Usage Note

- ***Gently touch on the display screen by a finger. Do not press too much or poke with a stick such as a ball-point pen. The glass may break and may cause an electrical shock.***

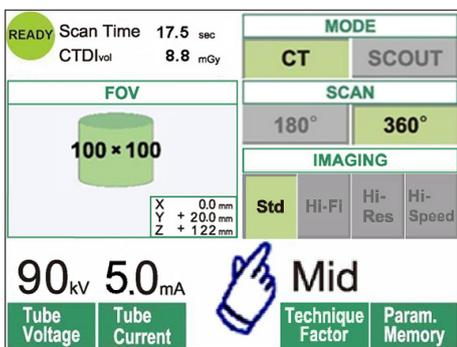

1. Press CT.

2. Press 180° or 360°.

3. Imaging Mode.

Select the Imaging Mode.

- Standard (Std) mode
17 second scan for all applications.
- High Fidelity (Hi-Fi) mode - optional
30 second scan for lower noise, better contrast resolution especially at peripheral area of an image, good for zoom reconstruction and volume rendering.
- High Resolution (Hi-Res) mode - optional
Higher spatial resolution for limited imaging area up to 60×60 FOV by using smaller pixel mode of the flat panel detector.
- High Speed (Hi-Speed) mode - optional
High speed rotation in 10 seconds for full scan, up to 60×60 FOV. It helps reduce motion artifact during scan.

4. Select the FOV (field of view).

* Refer to page 36 for how to change a FOV 40–140 setting to FOV 170.

- a. Press the FOV key to display the FOV selections (40×40, 60×60, 80×80, 100×100, 140×100, 170×120, 100×50, 140×50, or 170×50). (Only 40×40 and 60×60 for High Resolution and High Speed modes, optional)
- b. Press the key for the desired FOV.

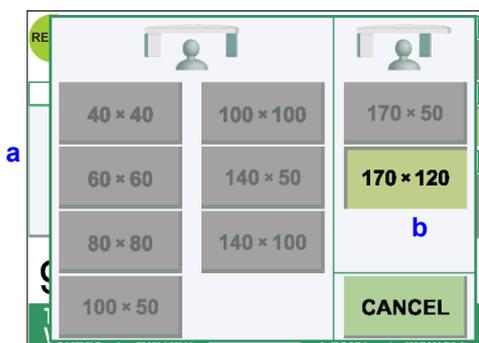

⚠ CAUTION

- ***In High Resolution and High Speed modes (optional), only 40×40 FOV and 60×60 FOV are available.***

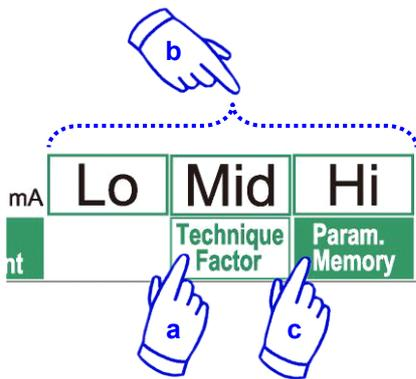

5. Select the Technique Factor.
 - a. Press the Technique Factor.
 - b. Select Lo, Mid, or Hi.
 - c. Hold the Param.Memory key down for 2 seconds.

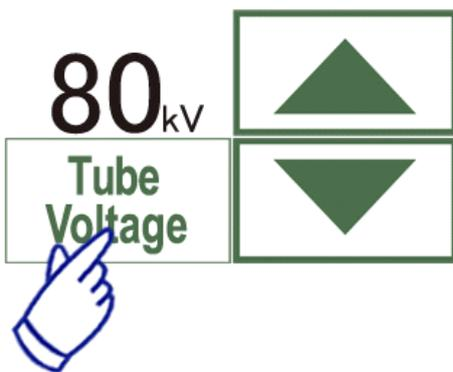

6. Set tube voltage.
 - (1) Press the Tube Voltage key.
 - (2) Up and Down keys will appear; press them to set the voltage (60 to 90 kV).
 - (3) Press the Tube Voltage key again.

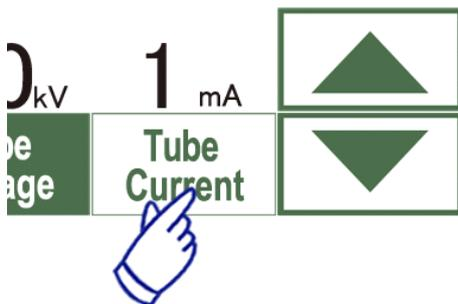

7. Set tube current.
 - (1) Press the Tube Current key.
 - (2) Up and Down keys will appear; press them to set the current (1 to 10 mA).
For High Fidelity and High Resolution modes (optional), the maximum selectable tube current is limited to 8 mA.
 - (3) Press the Tube Current key again.

* **Recommended: 90 kV and 4 to 6 mA.**

⚠ CAUTION

- ***In High Fidelity and High Resolution modes (optional), the maximum selectable tube current is limited up to 8mA.***

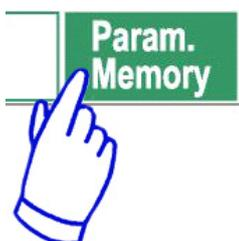

8. Press the Param.Memory key to save the current settings as those that will appear when the unit is turned on.
Hold the Param.Memory key down for at least 2 second to memorize the tube voltage and current for the currently selected scan mode and Technique Factor.

To Change the FOV

CAUTION

- *Follow the message in the display to change from a 40–140 FOV to a 170 FOV or vice versa.*
- *The chair may move when the FOV is changed.*

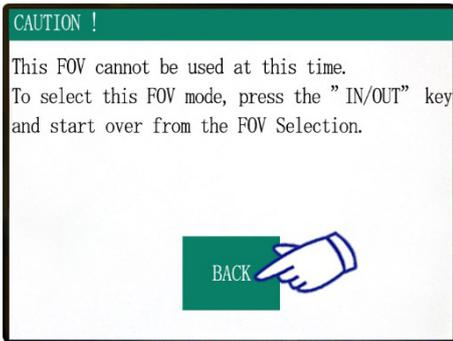

i) Change from a 40–140 FOV to a 170 FOV

To select the 170 FOV, press the "IN/OUT" key and start over from the FOV Selection. Press "Back" to return to the procedure for a 40–140 FOV exposure.

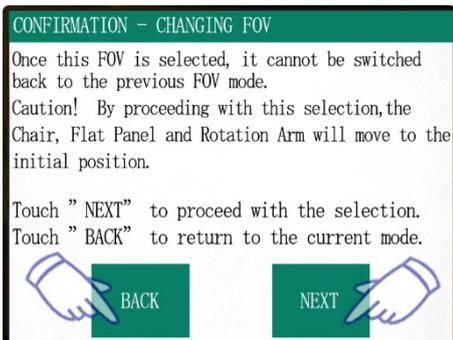

ii) Change from a 170 FOV to a 40–140 FOV

After this change is made, it is not possible to go back to the 170 FOV settings.
Press "Next" to change to a 40–140 FOV. Press "Back" to continue with the procedure for a 170 FOV.

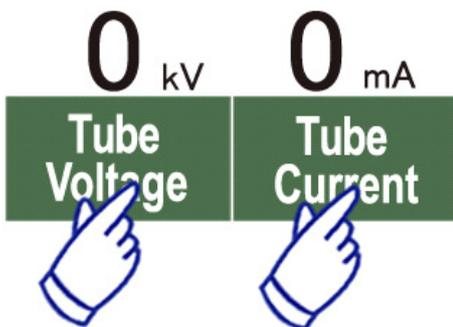

No X-ray Setting

Use this to check the arm's rotation without emitting any X-rays. Set the tube voltage or the tube current for 0. You may now check the arm's rotation to make sure it will not hit the patient or anything else.

To return to normal operation, simply reset the tube voltage and current to their normal values.

CT Exposure

Make sure the Ready LED on the control box is on. Press the Ready key if it isn't.

Insert the key and turn it to the right.

Pick up the hand switch and hold down the emission button. X-ray emission will begin and be signaled by a melody. Also the control box's buzzer will sound and the emission LED on the control box will light up. (Also the Ready key in the display will change to its X-ray emission status.)

Release the emission button when the buzzer stops sounding. Hang the hand switch back up on the control box. And turn the Key to the left and take it out.

During emission, the X-ray penetration image will appear in the computer monitor.

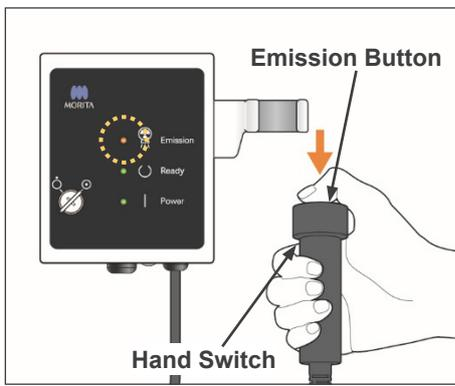

X Ray Emission Status

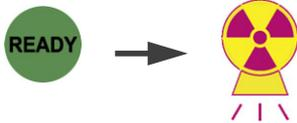

⚠ WARNING

- **If the X-rays are too strong and pass through some material such as air that has very low absorption, the detector in that area will be saturated. In the resulting image, the saturated area may falsely appear to entirely lack any tissue whatsoever. To make an accurate diagnosis, one should carefully watch the image produced during the exposure to identify saturation areas.**
- **For the 170 FOV, the flat panel detector passes quite close to the patient. Watch carefully and make sure it does not hit him/her.**
- **Leave the X-ray booth, and hold the emission button down outside of it.**
- **In case of an emergency release the emission button or press the emergency switch. Guide the patient away from the unit as soon as it stops moving.**
- **Wear appropriate X-ray protection gear such as lead-impregnated clothing when remaining in the X-ray protection area during exposure from unavoidable circumstances.**
- **High Fidelity and High Resolution modes (optional) require a longer exposure time to complete a scan. Use these modes only when necessary.**
- **The rotation arm moves quickly in High Speed mode (optional). Pay special attention to the arm rotation not to pinch or hit against any parts of body or other objects including the chin-rest and head-rest.**

⚠ CAUTION

- **Warn the patient not to move while the melody is playing. Otherwise, the arm might hit him/her and spoil the image.**
- **Hold down the emission button until the exposure has been completed. If you release it too soon, X-ray emission will stop and the image data will be lost.**

Usage Note

- *If the 3D Viewer is running when X-ray emission is initiated, it will close automatically, and the i-Dixel application will return to the Image List screen.*
- *If the image in the 3D Viewer has been edited or modified, this data will be saved.*
- *If the saved data is not needed, delete it manually after the X-ray emission is over. Refer to the user manual for the i-Dixel application for how to delete the data.*

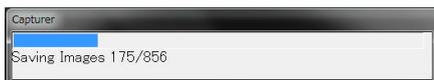

Image transmission in progress

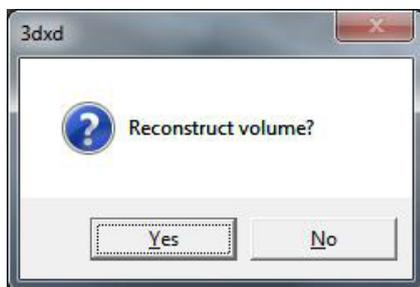

Image Reconstruction

After X-ray emission, the image data will be sent to the computer and the i-Dixel software will automatically begin to process it. The message "Reconstruct volume?" will appear.

Click "No" to wait until later to reconstruct the image.

Click "Yes" to reconstruct the image immediately. After processing, the XYZ slice window will open.



Next a dialogue box will ask if you wish to save the CT Task. Click "Yes" if you wish to perform procedures such as reslicing, volume rendering, 3D image processing etc.

(The CT Task is the basic, raw data used to create slice and 3D images.)

⚠ CAUTION

- ***Do not delete the CT Task until you have completed all necessary image processing such as reslicing and volume rendering.***
- ***CT Tasks require considerable space on the hard disk and should be deleted periodically.***

- * Image reconstruction takes from 3 to 20 minutes depending on the FOV and the computer's processing speed.
- * Refer to the user's manual for the i-Dixel software for details concerning various image processing procedures such as reslicing, volume rendering, and 3D imaging.

Scout Exposure Settings

[Positioning for Scout Exposure]

For 40–140 FOV, check the location of the laser beams.

* Making a Scout image simplifies the procedure for making a CT scan.



The Scout appears as two images at different angles. Select a point in the two-direction scout to fix the center of the FOV. The arm and slit for the X-ray beam will automatically move accordingly.

⚠ CAUTION

- *The scout function is only used as a reference in positioning. The absolute accuracy of positioning is not guaranteed.*
- *Do not close the scout window until the CT exposure has been completed. Once the scout window has been closed, it can no longer be used for positioning.*
- *The accuracy of the scout is ± 3 mm.*

1. Select Scout exposure

2. Set Tube Voltage

3. Set Tube Current

4. Memory Key
(Exposure conditions memory. Sets initial conditions when unit is turned on.)

Usage Note

- *Gently touch on the display screen by a finger. Do not press too much or poke with a stick such as a ball-point pen. The glass may break and may cause an electrical shock.*

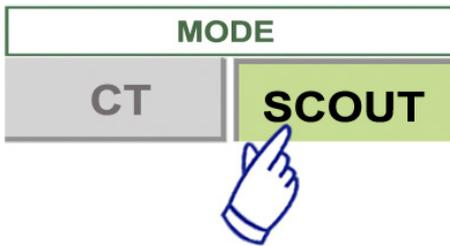

1. Select Scout exposure mode.
2. Select the FOV (field of view)
 - a. Press the FOV key to display the FOV selections (40×40, 60×60, 80×80, 100×100, 140×100, 170×120).
 - b. Press the key for the desired FOV.

FOV cannot be changed from 170FOV to 40–140FOV or vice versa.
 Start from IN/OUT FOV size of Scout Exposure is always equal to or larger than that of CT Exposure.
 FOV size of CT Exposure may be automatically changed depending on the FOV size of Scout Exposure selected.

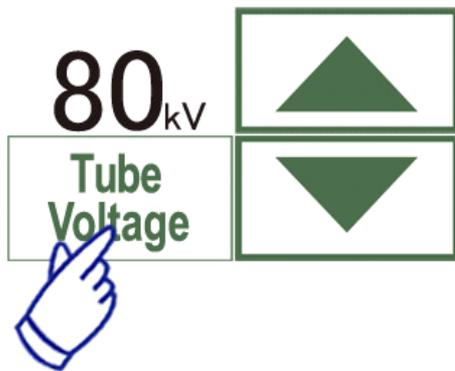

3. Set Tube Voltage
 - (1) Press the Tube Voltage key.
 - (2) Up and Down keys will appear; press them to set the voltage. (60 to 90 kV).
 - (3) Press the Tube Voltage key again.

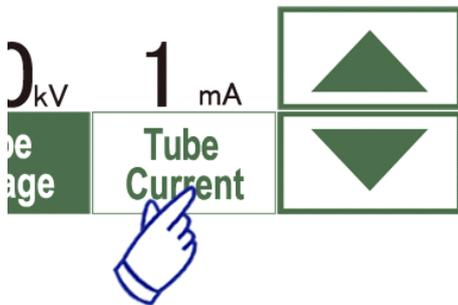

4. Set Tube Current
 - (1) Press the Tube Current key.
 - (2) Up and Down keys will appear; press them to set the current. (1 to 10 mA).
 - (3) Press the Tube Current key again.

*** Recommended: 80 kV and 2 or 3 mA.**

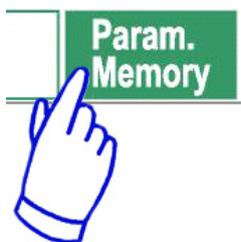

5. Press the Param.Memory key to save the current settings as those that will appear when the unit is turned on.
 Hold the Memory key down for at least 2 second to memorize the current tube voltage and tube current.

Scout Exposure

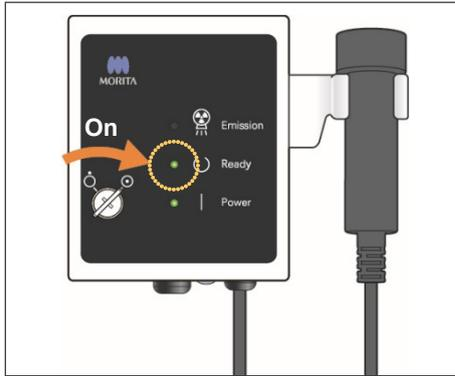

Make sure the Ready LED on the control box is on. Press the Ready key if it isn't.

Insert the key and turn it to the right.

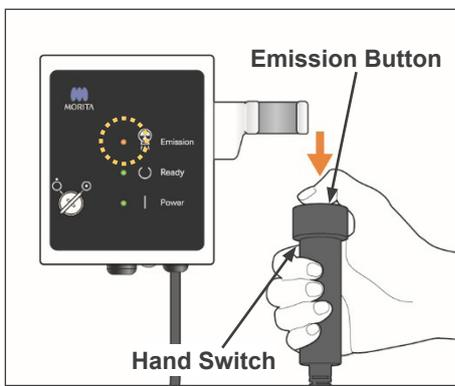

Pick up the hand switch and hold down the emission button. X-ray emission will begin and be signaled by a melody. Also the control box's buzzer will sound and the emission LED on the control box will light up. (Also the Ready key in the display will change to its X-ray emission status.)

* Hold down the emission button until two exposures are completed (until the melody stops playing). Release the emission button after the second emission buzzer stops sounding completely. Hang the hand switch back up on the control box. And turn the Key to the left and take it out.

X Ray Emission Status



⚠ WARNING

- **Leave the X-ray booth, and hold the emission button down outside of it.**
- **In case of an emergency release the emission button or press the emergency switch. Guide the patient away from the unit as soon as it stops moving.**
- **Wear appropriate X-ray protection gear such as lead-impregnated clothing when remaining in the X-ray protection area during exposure from unavoidable circumstances.**

⚠ CAUTION

- **Warn the patient not to move while the melody is playing. Otherwise, the arm might hit him/her and spoil the image.**
- **Watch out for the chair's motion when the scout exposure is made.**
- **Hold down the emission button until the second exposure is completed. If you release it after the first exposure, all the image data will be lost.**

Usage Note

- **If the 3D Viewer is running when X-ray emission is initiated, it will close automatically, and the i-Dixel application will return to the Image List screen.**
- **If the image in the 3D Viewer has been edited or modified, this data will be saved.**
- **If the saved data is not needed, delete it manually after the X-ray emission is over. Refer to the user manual for the i-Dixel application for how to delete the data.**



Image transmission in progress

After X-ray emission, the image data will be sent to the computer and the i-Dixel software will automatically begin to process it.

- * For the 40–140 FOV, an unexposed area will appear around the scout image.



Usage Note

- **If you click on the image repeatedly or drag the box around for a long time, the computer's react may slow up and freeze.**
- **Do not press any of the keys on the control panel as long as the box for selecting the image area appears in the computer monitor. The keys could become disabled.**

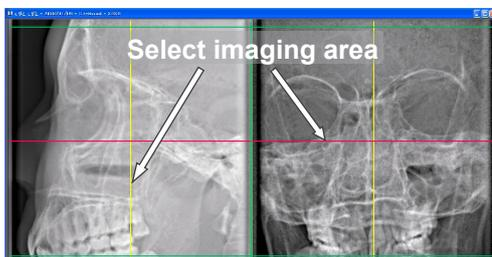

The two scout images will appear in the computer monitor. The red and yellow lines pass through the center of the imaging area, and the green box indicates the size of the area. Drag the lines or the point where they intersect to select the CT imaging area.

- * Check the control panel display and make sure it is set for a scout exposure.



Once you have selected the imaging area, click the SetPos button on the tool bar. A plus mark will appear at the centers of the imaging areas shown in the scout images, and a message will appear in the display on the control panel concerning patient positioning.

Usage Note

- **Click SetPos button after changing the cursors, otherwise the cursor position will not be sent to the device to set the CT position.**
- **If the device is in an error state, SetPos information will not be sent to the device to set the CT position and the center position "+" marks will not be displayed on the screen. Restore the device from the error state and set the scout position again by SetPos button, or restart from another scout scan.**

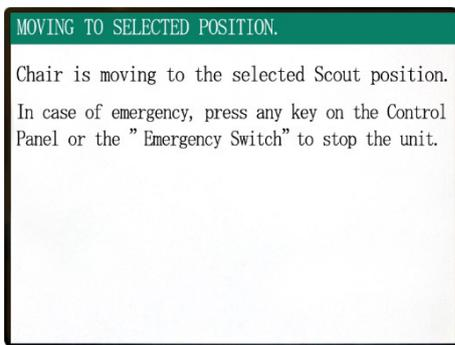
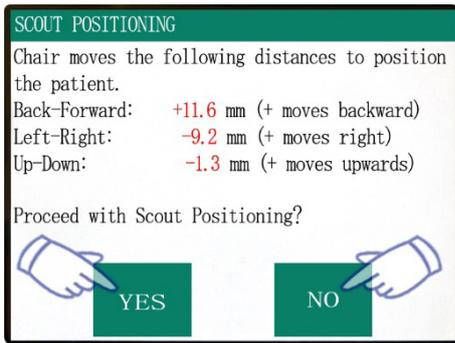

If you click Yes, the unit will sound a two-toned beep and a buzzer. The arm and chair will move into their positions, and a new message will appear in the display on the control panel. Click No, if you wish to repeat the scout image or select another type of exposure



If you drag a cursor outside the imaging range, it will turn red and a message will appear in the control panel display saying that the setting is out of range.

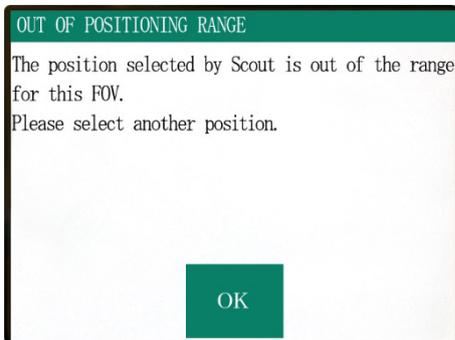

Change FOV with i-Dixel software

Click the CT Area button. A dialogue box will appear.



Click the pull down triangle, select the FOV size, and then click OK.

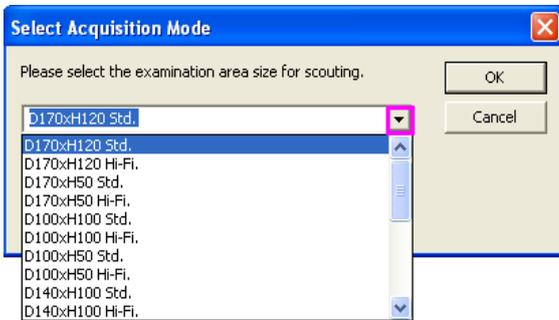

⚠ CAUTION

- *The 170 FOV cannot be selected if the unit is already set for 40–140.*

A beep will sound and the size of the area will change.

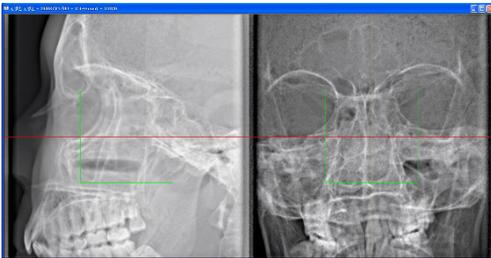

⚠ WARNING

- *Never take your eyes off the patient during a scout scan. In case of an emergency, stop the chair by pressing the emergency switch, any key on the control panel or any key on the remote control except the position memory key. (Keys in the display cannot be used to stop the chair in an emergency.)*

Usage Note

- *When you've finished positioning the patient, perform a final visual confirmation using the three position beams.*
- *If the beams have gone off, turn them back on with the Beam On / Off key.*

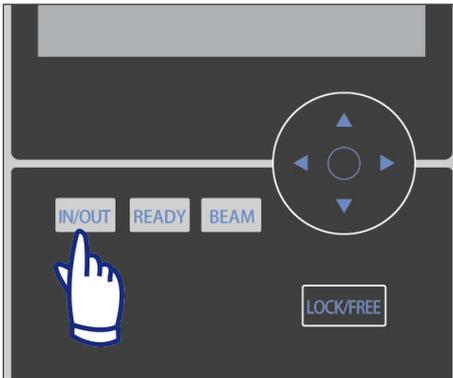

Patient Egress

Warn the patient that the chair will move and make sure the area is free of obstacles. Press the In / Out key on the control panel.

⚠ WARNING

- **The arm and chair will move. In case of an emergency press the emergency switch, any key on the control panel or any key on the remote control except the position memory key. (Keys in the display cannot be used to stop the arm and chair in an emergency.)**

(* Refer to page 11 for how to restore normal working order after pressing the emergency switch. If you stopped the unit by pressing some other key, press the Ready key to restore normal operation.)

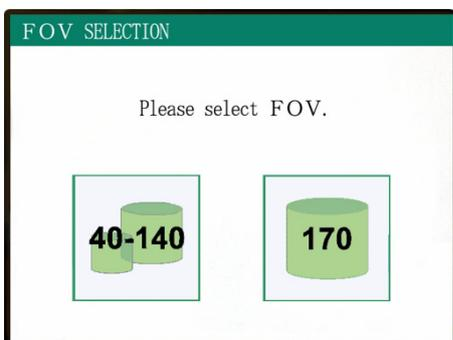
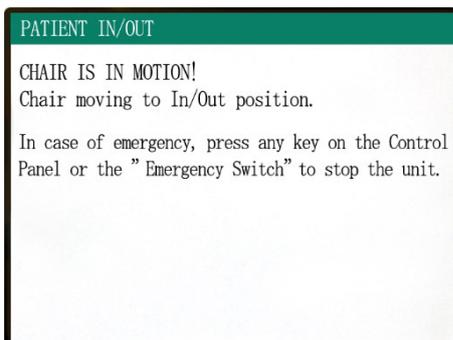

A message will appear in the display, and the chair and arm will move to the patient egress position.

The Ready LED on the control box will start blinking on and off. Move the chinrest, remove the headband, and guide the patient away from the unit.

After Use

Turn the main switch off.

Turn off the main switch located on the lower part of the back of the left support column.

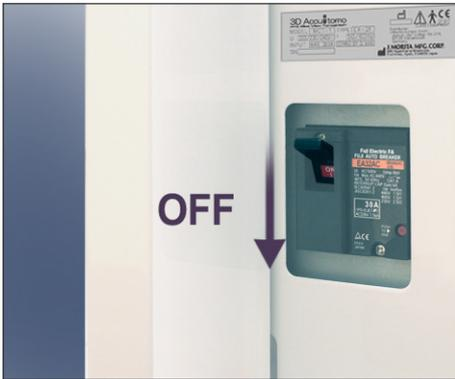

⚠ WARNING

- ***Do not fail to turn off the main switch. This eliminates the risk of electrical leakage and accidental operation.***

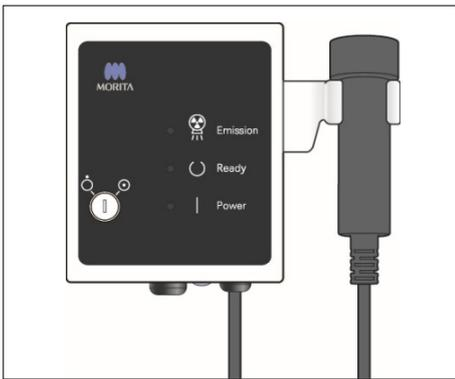

The power LED will go out.

Automatic Cooling Intervals of X-Ray Head

⚠ CAUTION

- To use the X-ray head assembly under appropriate load conditions, leave an interval of approximately 5 minutes for each irradiation and leave an additional 15 minutes after every 3 irradiations.

After each irradiation, the system will automatically leave a short interval calculated from the amount of energy based on the current settings of tube voltage, tube current and scan time to cool the X-ray tube down. Also, after every 4 irradiations, the system requires an additional cooling time of 15 minutes in order to cool down the X-ray head and high voltage circuit.

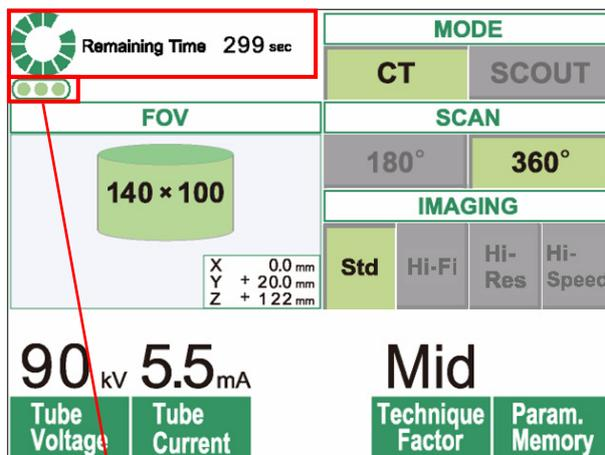

When one scan is completed, a green circle and "Remaining Time" will appear at the top of the LCD panel. While the green circle is rotating, the remaining time counts down. When the remaining time reaches zero, the circle will change to "Ready".

The green dots below the green circle indicate the remaining number of irradiations allowed before a longer cooling interval is required. For example, when there are three dots shown, there are three irradiations possible before the 15-minute cooling interval.

Remaining number of irradiations allowed before the long 15-minute cooling interval

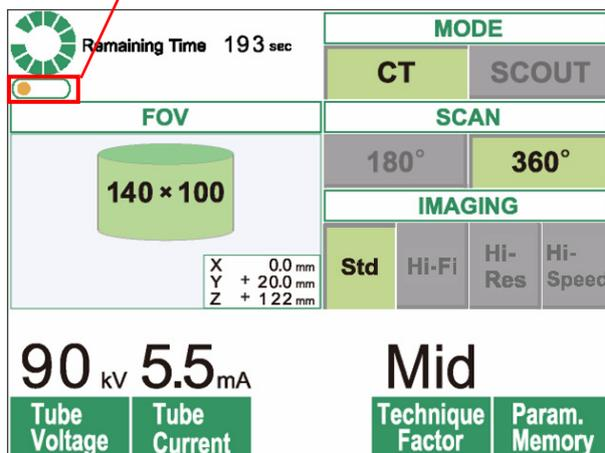

⚠ CAUTION

- The rotating green circle also works as the **READY** key. **Be cautious of the arm rotation as it returns to the ready position when you touch this green circle.**

As shown in the figure on the left, there is only one orange dot left in the indicator. This means that there is only one irradiation remaining before the longer cooling interval. After the last irradiation, you must wait for 15 minutes for the system to cool down and be ready for the next set of irradiations.

The default cooling intervals applied are automatically calculated from the minimum requirements of the related components. Regardless of the default cooling intervals, please try to leave as much time as possible between irradiations to ensure the system will continue to provide good quality images for the longest possible time.

3. Maintenance, Parts Replacement, and Storage

Maintenance

[Daily Maintenance]

Disinfect the control panel, remote control, headrest, armrest, chinrest, seat, auxiliary seat, headband, and headrest cushion after each patient by wiping them with Ethanol for Disinfection (Ethanol 70 vol% to 80 vol%).

Wipe the operation panel with Ethanol for Disinfection (Ethanol 70 vol% to 80 vol%).

⚠ WARNING

- ***Always turn off the main switch before you perform maintenance work. This is necessary to avoid getting an electrical shock or burn, as well as to prevent the CT unit from sudden operation through inadvertent contact with a switch or similar action.***
- ***Never remove the covers of the CT unit.***

Usage Note

- ***Use only Ethanol for Disinfection (Ethanol 70 vol% to 80 vol%) or a neutral detergent to clean outer surfaces. Never use alkaline or acidic solutions, cresol soap, or other chemical solutions; this could cause discoloration or degrade the materials.***
- ***If any water, detergent, cleaning solvent, or other chemical solutions get on the outer surfaces, wipe them off immediately with Ethanol for Disinfection (Ethanol 70 vol% to 80 vol%).***
- ***Do not use ozone water to clean the unit. Ozone water could damage to the unit.***
- ***Do not disinfect the clinic with ozone gas or ultraviolet light. This could damage plastic and rubber components.***
- ***When cleaning the unit with Ethanol for Disinfection (Ethanol 70 vol% to 80 vol%), take care that none of it seeps inside; this could damage the unit.***

Parts Replacement

- * Replace the parts as necessary depending on degree of wear and length of use.
- * Order replacement parts from your local dealer or J. MORITA OFFICE.

Storage

- * Storage Environments
 - Temperature: -5°C to +43°C (+23°F to +109.4°F)
 - Relative Humidity: 8% to 85% (without condensation)
 - Atmospheric Pressure: 70 kPa to 106 kPa
 - No frequent or continuous exposure to direct sunlight.
- * If the unit has not been used for some time, make sure it works properly before using it again.

4. Regular Inspection

- Maintenance and inspection are generally considered to be the duty and obligation of the user, but if, for some reason, the user is unable to carry out these duties, he/she may rely on a qualified medical device serviceman. Contact your local dealer or J. MORITA OFFICE for details.
- This unit should be inspected for all the items in the following list once a year.
- At the start and end of each business day, make sure that switching the main switch to ON and OFF turns the equipment on or off without fail.

Daily Inspection

	Item	Description
1	Main Power	Check that the power turns on and off when the key switch is turned on and off
2	Remote control of the chair and headrest	Make sure the remote control moves the chair and headrest properly and that there is no abnormal noise or vibration etc.
3	Data acquisition monitoring and slice image creation	Make sure the acquisition of the image data is being properly monitored by the software. Make sure data is reconstructed and slice images are created.
4	Arm Rotation	No abnormal noise, vibration etc. during CT scan
5	Warning messages	Make sure no warning messages appear when the computer is turned on or at other times.
6	Hard Disk Space	Make sure there's enough empty space on the hard disk

Regular Inspection List

	Category	Test	Methods & Standards	Instrument etc.
1	Electrical Safety	Supplied Voltage	110/115/120 V +/- 5% (single phase, min. capacity 10 A)	Tester
		Grounding	Ground line must be firmly connected.	Visual
		Emergency Switch	When the emergency switch is activated, the motor and chair operation must stop, with a warning message generated.	
		Head Safety Switch	When the head safety switch is activated, the motor and chair operation must stop, with a warning message generated.	
2	Installed Condition of Equipment	Centering of the Rotation Arm	The plumb in the video image must not tilt, drift or jump during arm rotation.	Plumb adjustment software
		Emergency Stop of the Arm	When arm rotation is hindered by force applied to either side of the arm during rotation, the arm rotation must stop, with a warning message generated.	
		Centering of the Arm Motor	The plumb in the video image must not move to the left or right during arm rotation.	Plumb adjustment software
		X-ray Field	The X-ray field is evenly surrounded by a non-exposed area.	QA software
3	Positioning Beam	Beam Adjustment	All beams must align with the plumb line.	Plumb
		Brightness	Beams must be fully visible under normal room lighting.	-

	Category	Test	Methods & Standards	Instrument etc.
4	Mechanical Movement	Moving Parts	There must be no abnormal noise or vibration during any mechanical movement.	-
		Greasing	Moving parts must be appropriately greased.	-
		Z-axis Belt	There must be no slack or wear.	-
		Routing of Cables	No cables must be caught in moving parts or otherwise damaged by them.	-
5	Base Installation	Level Adjustment	The plumb must point to the center mark on the chair. All level adjusters (jacks) must evenly contact the floor.	Plumb and level
		Fixing Bolts	The level adjusters must be secured.	-
6	Functionality	Operation Switches	All key switches, including the display screen, operation panel, and emission buttons must operate correctly.	-
7	X-Ray Control	High Voltage Control	In Service Mode, the maximum deviation of displayed kV and mA must be within +/-10% of the set value.	Service Mode
8	Head Assembly	Oil Leakage	There must be no leakage of insulation oil (rubber chamber part).	-
9	Exterior	Patient Supports	There must be no breakage, dirt, or other damage that could injure the patient or operator.	-
		Exterior	There must be no flaws, dents, or other damage that could injure the patient or operator.	-
10	PC Functionality	Basic Functions	No alarms or errors must occur when the PC starts or software is run.	-
		Storage Devices	No disk errors or other detection errors must be found when Windows event logs are checked.	-
		LAN Card	The video grabber board must be inserted straight into position and must have its cable firmly connected. There must be sufficient space behind the PC to prevent cables and connectors from being stressed.	-
11	Performance Test	Spatial Resolution	The MTF value must be 10% or more at 2 lp/mm.	Wire phantom, QA software
		Noise	The noise value (standard deviation of the displayed density at center of the acrylic part of a contrast phantom) must be less than 5% (+/-6.4) of full scale (256).	Contrast phantom, QA software
		Grayscale/uniformity	The uniformity (standard deviation of the displayed density from the average value at center and in four peripheral points of the acrylic part of a contrast phantom) must be less than 5% (+/-6.4) of full scale (256).	Contrast phantom, QA software
		Contrast Resolution	The ranges of standard deviation of the displayed density (noise) of four materials must not overlap each other.	Contrast phantom, QA software
		Image Verification (Artifact)	There must be no noticeable artifacts (false images) in CT images of a 3-dimensional phantom that could interfere with diagnosis.	3D phantom
		Patient Positioning	When a 3-dimensional phantom is positioned using beams and scouts, the displacement between its center and that of the image must be +/- 2 mm.	3D phantom

5. Troubleshooting

If the equipment operation does not seem to be normal, check or adjust the following before requesting a repair service.

- If the equipment does not operate properly after the inspection, adjustment, or parts replacement or if you cannot perform the inspection yourself, contact your local dealer or J. MORITA OFFICE.
- The inside parts of the equipment are charged with high voltage. Do not attempt to perform maintenance or adjustment that is not described in the troubleshooting table.
- If an accident occurs, the equipment must not be used until repairs have been completed by a qualified and trained technician provided by the manufacturer.
- Contact your local dealer or J. MORITA OFFICE for repairs if the apparatus does not work normally even after performing the steps recommended below.

<Error and operation messages that might appear in the LCD>

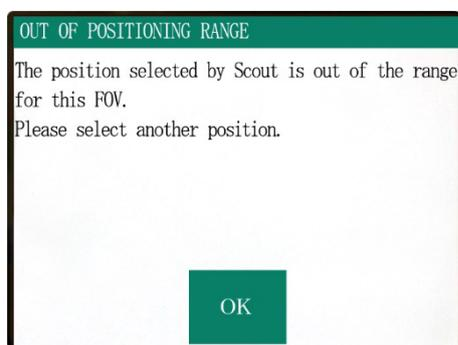

This is displayed when the user specifies an area outside the range of chair movement for a two-direction scout scan.
Check the selected scan area again.

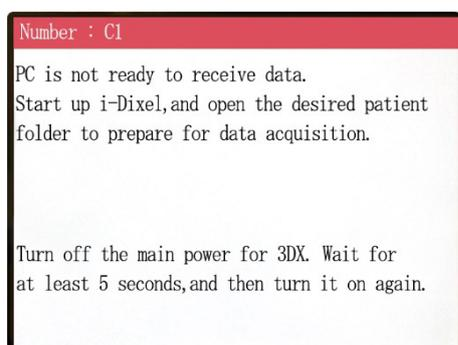

This is displayed when the PC is not ready.
After confirming that the PC is on and the program is up and running, press any key on the control panel or remote control.
If the system cannot be restored, temporarily turn off the power. After confirming that the PC is ready, restart the CT unit.

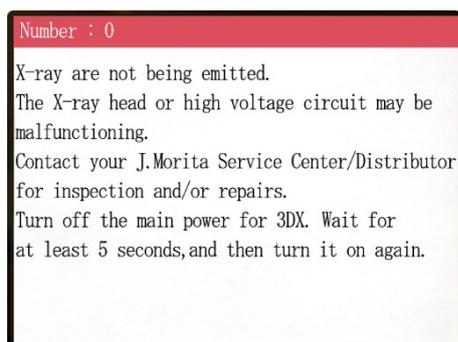

This is displayed when an abnormality has been found in the X-ray generator circuit. Stop using the CT unit and contact your local dealer or J. MORITA OFFICE.

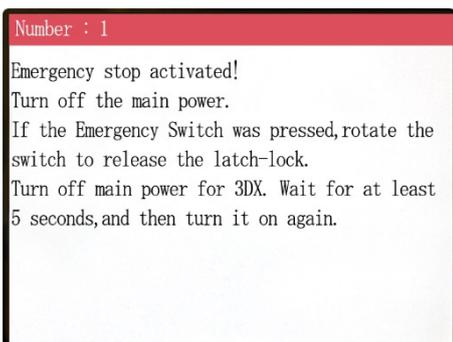

This is displayed when the emergency switch has been actuated.
Turn off the power, and after waiting five seconds or more, turn it back on again.
If the CT unit still cannot be restored, stop using the unit and contact your local dealer or J. MORITA OFFICE.

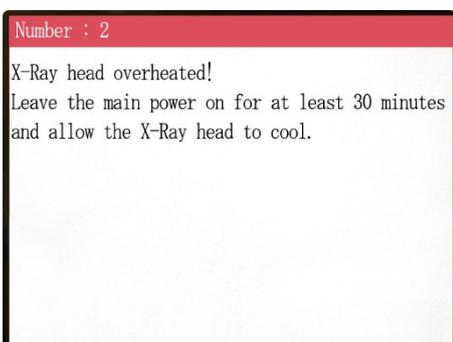

This is displayed when the X-ray head is overheated.
Leave the CT unit on and wait at least 30 minutes until the unit cools. Leave enough time between exposures for the X-ray tube and high voltage circuits to cool off.

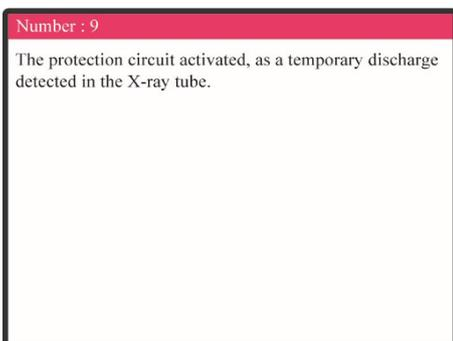

Number: 9, 11 (The same message will be shown for either error number.)
The protection circuit activated, as a temporary discharge detected in the X-ray tube.
Turn off the power, and after waiting five seconds or more, turn it back on again.
If the CT unit still cannot be restored, stop using the unit and contact your local dealer or J. MORITA OFFICE.

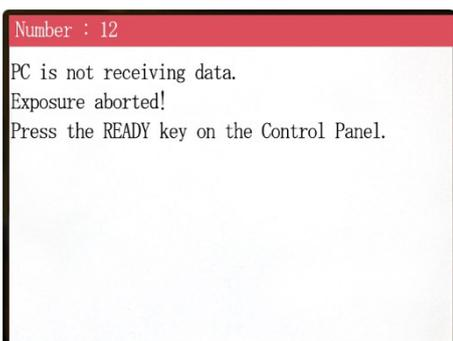

This is displayed when the PC is not ready or there is a problem with the connection with the PC, or when the optical receiver is not turned on.
Check the PC, cable connections, and the power for the optical receiver.

Number : 13

Communication cannot be established with i-Dixel program.
i-Dixel may not be running or may be busy processing data.
Start up i-Dixel or wait for it to be free.
Then turn off the main power for 3DX, wait for at least 5 seconds, and then turn it on again.

This is displayed when the PC is not ready or the driver software is busy processing image data.
After confirming that the PC is on, the program is up and running, and that the driver software is not busy, press the Ready key.
Otherwise, restart the program and turn the power to the CT unit briefly off and then back on again.

Number : 16

Operation aborted.
A key on the Control Panel or the Emission Button was pressed during positioning.
To resume operation, press the READY key on the Control Panel. The Chair and Rotation Arm will return to their initial positions.
If there are any safety concerns turn off the main power, and let the patient out of the chair.
Then turn on the main power and check that the system is functioning properly.
Press the READY key on the Control Panel.

This is displayed when automatic movement of the chair is stopped through pressing of a key on the control panel or remote control.
To restore, confirm that there is no danger to the patient and press the Ready key.
If positioning by scout scan is underway, press the Ready key and be sure to specify the scan area again on the PC.

Number : 17

Communication with the Rotation Arm Motor controller failed.

Press the READY key on the Control Panel.

This is displayed when a problem has been found in communications with the motor controller of the rotation arm.
Press the Ready key on the control panel.
If the CT unit cannot be restored, temporarily turn off the power to the CT unit and then restart.
If the CT unit still cannot be restored, stop using the unit and contact your local dealer or J. MORITA OFFICE.

Number : 18

Rotation Arm stopped!
Rotation Arm Motor alarm activated.
To cancel the alarm, press the READY key on the Control Panel.

Press the READY key on the Control Panel.

This is displayed when abnormal operation of the arm motor has been detected.
If continuing operation involves a risk, ask that the patient exit the CT unit, and turn the power briefly off and then on to check for any abnormality in the CT unit.
To restore, confirm that there is no danger to the patient and press the Ready key.

Number : 19

Chair stopped!
An error occurred during vertical motion.
IF there are any safety concerns, turn off the main power, and let the patient out of the chair.
Then turn on the main power and check that the system is functioning properly.

Press the READY key on the Control Panel.

If continuing operation involves a risk, ask that the patient exit the CT unit and turn the power briefly off and then on to check for any abnormality in the CT unit.
To restore, confirm that there is no danger to the patient and press the Ready key.

Number : 20

Irradiation aborted!
To resume operation, press the READY key on the Control Panel. The Chair and Rotation Arm will return to their initial positions.

Press the READY key on the Control Panel.

This is displayed when a scan has been aborted by the operator. In this case, only a partial image can be processed.
When you press the Ready key, the chair returns to its home position, and the CT unit is restored to the normal operating state.

Number : 21

Initial data error found in the collimator position memory.
Patient positioning may be continued with the Remote Control only.
Any automated chair operations (patient IN/OUT, Scout positioning and position memory) will be disabled.
Contact your J. Morita Service Center/Distributor for inspection and/or repairs.

Press the READY key on the Control Panel.

This is displayed when an error has been found in the backup data (initial setting data) stored in the CT unit.
To avoid danger, automatic positioning in the direction of height and chair-position memory can no longer be used.
Since in this case inspection and adjustment are required, please contact your local dealer or J. MORITA OFFICE.

Number : 22

Initial data error found in the collimator position memory.
Proper X-ray collimation may not be selected.
Call J. Morita Service/Distributor for inspections and/or repairs.

Press the READY key on the Control Panel.

This is displayed when an error has been found in the collimator that limits the X-ray irradiation area.
The correct radiation field may not be selected.
Since in this case inspection and adjustment are required, stop using the CT unit and contact your local dealer or J. MORITA OFFICE.

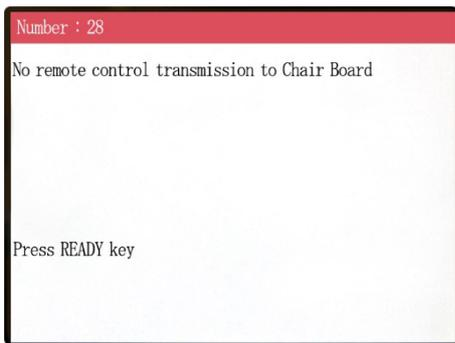

Problem with chair remote control transmission. Press the Ready key. If this does not solve the problem, turn the unit off and then try again. If this still does not solve the problem, stop using the unit and contact your local dealer or J. MORITA OFFICE.

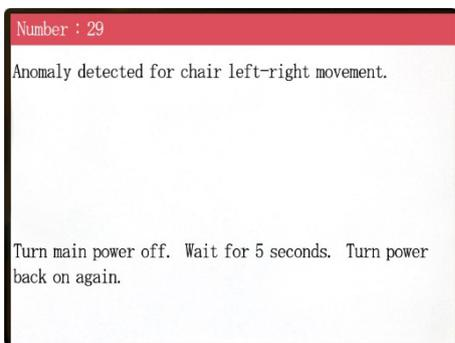

Anomaly detected for chair movement. Guide the patient away from the unit. Turn main power off. Wait for 5 seconds. Turn power back on again. If this still does not solve the problem, stop using the unit and contact your local dealer or J. MORITA OFFICE.

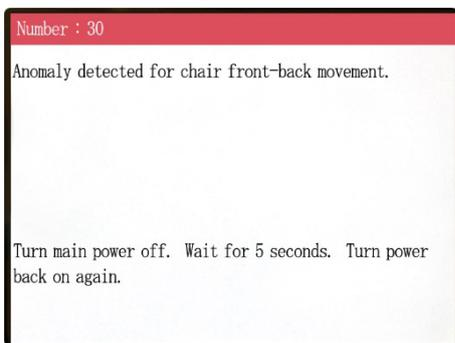

Anomaly detected for chair movement. Guide the patient away from the unit. Turn main power off. Wait for 5 seconds. Turn power back on again. If this still does not solve the problem, stop using the unit and contact your local dealer or J. MORITA OFFICE.

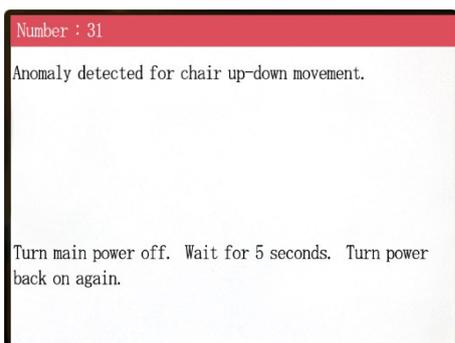

Anomaly detected for chair movement. Guide the patient away from the unit. Turn main power off. Wait for 5 seconds. Turn power back on again. If this still does not solve the problem, stop using the unit and contact your local dealer or J. MORITA OFFICE.

Number : 32

Stopped because chair left-right position cannot be detected.

Turn main power off. Wait for 5 seconds. Turn power back on again.

Anomaly detected for chair movement.
Guide the patient away from the unit. Turn main power off. Wait for 5 seconds. Turn power back on again. If this still does not solve the problem, stop using the unit and contact your local dealer or J. MORITA OFFICE.

Number : 33

Stopped because chair front-back position cannot be detected.

Turn main power off. Wait for 5 seconds. Turn power back on again.

Anomaly detected for chair movement.
Guide the patient away from the unit. Turn main power off. Wait for 5 seconds. Turn power back on again. If this still does not solve the problem, stop using the unit and contact your local dealer or J. MORITA OFFICE.

Number : 34

Stopped because chair up-down position cannot be detected.

Turn main power off. Wait for 5 seconds. Turn power back on again.

Anomaly detected for chair movement.
Guide the patient away from the unit. Turn main power off. Wait for 5 seconds. Turn power back on again. If this still does not solve the problem, stop using the unit and contact your local dealer or J. MORITA OFFICE.

Number : 35

Stopped because of a larger error in the X coordinate for the chair.

Press the Ready key to return the chair to its initial starting position.
This should restore normal operation.

Press Ready key.

Anomaly detected for chair movement.
If continued use presents some danger, Guide the patient away from the unit. Turn main power off, and then turn it back on again. Make sure the unit is operating normally and safely.
If normal operation has been restored, check that the unit is safe for the patient and press the Ready key.

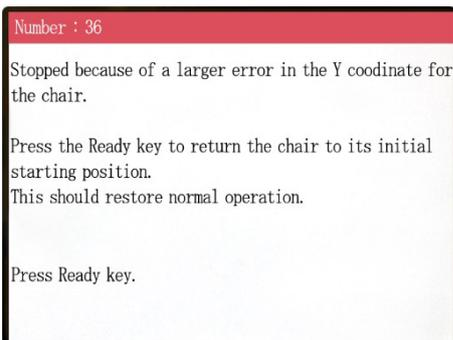

Anomaly detected for chair movement.
If continued use presents some danger, Guide the patient away from the unit. Turn main power off, and then turn it back on again. Make sure the unit is operating normally and safely.
If normal operation has been restored, check that the unit is safe for the patient and press the Ready key.

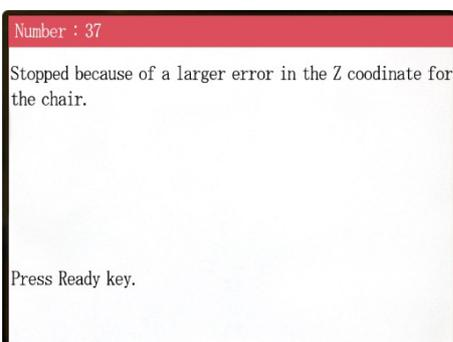

Anomaly detected for chair movement.
If continued use presents some danger, Guide the patient away from the unit. Turn main power off, and then turn it back on again. Make sure the unit is operating normally and safely.
If normal operation has been restored, check that the unit is safe for the patient and press the Ready key.

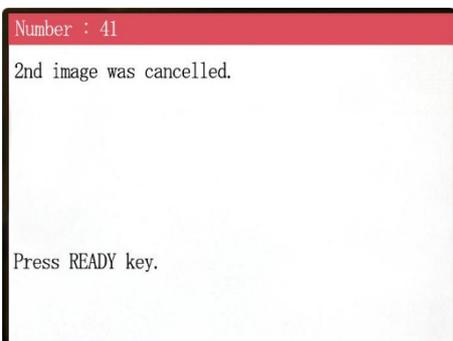

Scout scan was not completed. The second exposure was cancelled by releasing Emission Button after the first exposure. Emission Button must be kept pressed until the second exposure is completed. Press READY key and retry scout scan.

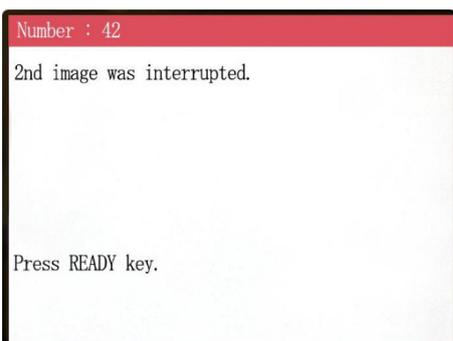

Scout scan was interrupted during the second exposure. Emission Button may have been released before the second exposure is completed. Press READY key and retry scout scan.

If this error still occurs even though Emission Button is kept pressed, stop using the unit and contact your local dealer or J. MORITA OFFICE.

WARNING !

Teaching has not been performed for the axes noted below.
 Switch to serviceman mode and perform the required teaching procedures.
 After completing the teaching, turn the unit off briefly and back on again.

Press any key on the control to continue.

X, Y, Z, H

There is some problem with the back-up or teaching data. This requires inspection and adjustment. Contact your local dealer or J. MORITA OFFICE.

WARNING !

Scout Positioning has been canceled, as the Chair was moved by the Remote Control.
 To reactivate the Scout Positioning, set the "CT imaging position" and transmit it from the PC, again.

Press READY key.

CT position selected by Scout scan is cancelled when the chair position is moved manually by Remote Control.

Press READY key and start from selecting the CT imaging area on the PC again, or taking another scout scan.

CT scan can be taken at the position manually selected by Remote Control. However, the link from the scout image to the CT image will be cancelled and the CT image can not be opened from the scout image. There is some problem with the back-up or teaching data. This requires inspection and adjustment. Contact your local dealer or J. MORITA OFFICE.

<Problems with Scanning and the CT Unit>

Problem	Conceivable Cause	Solution
<ul style="list-style-type: none"> • Lines are superimposed on the image. • A part of the image is lost. • The image is entirely black. <p>One of the following symptoms is encountered:</p> <ul style="list-style-type: none"> • While in use, the unit behaves the same way as it does when it first turns on. • The switch does not work. 	<ul style="list-style-type: none"> * Noise may have been introduced. * The power supply may have been momentarily interrupted. 	<p>Temporarily turn the power off, and after confirming that the patient and the user are in a safe place, turn it back on again and ensure that the CT unit operates normally.</p> <p>Make sure the power used for the CT unit is 220/230/240 VAC with a capacity of 10 A or more and supplied from a single, devoted circuit, and that the power is properly grounded. During scanning, do not use any other device in the vicinity that may generate noise.</p>

6. Cautionary Remarks on Imaging

Artifacts Due to Sensitivity Discrepancies of the Flat Panel Detector

The flat-panel detector (FPD) is an extremely dense and precise array of photo diodes (pixels). By compensating for the discrepancy in pixel sensitivity, the image can show greater detail than ordinary fluoroscopy. However, this discrepancy cannot be completely eliminated when a CT image is reconstructed.

To make a CT image, the X-ray beam rotates around the object and produces a fluoroscopic image. Points away from the center of the imaging area move on the imaging surface depending on the angle of their projection. This tends to even out the fluctuations in sensitivity, but it does not completely eliminate them. (See Fig. 1.)

Therefore, artifacts can appear near the center of the imaging area as shown in Fig. 2. The appearance of these artifacts depends somewhat on the exposure conditions and the X-ray transparency of the object.

To make a detailed analysis and precise diagnosis, the radiologist must carefully take into consideration the possibility and nature of artifacts.

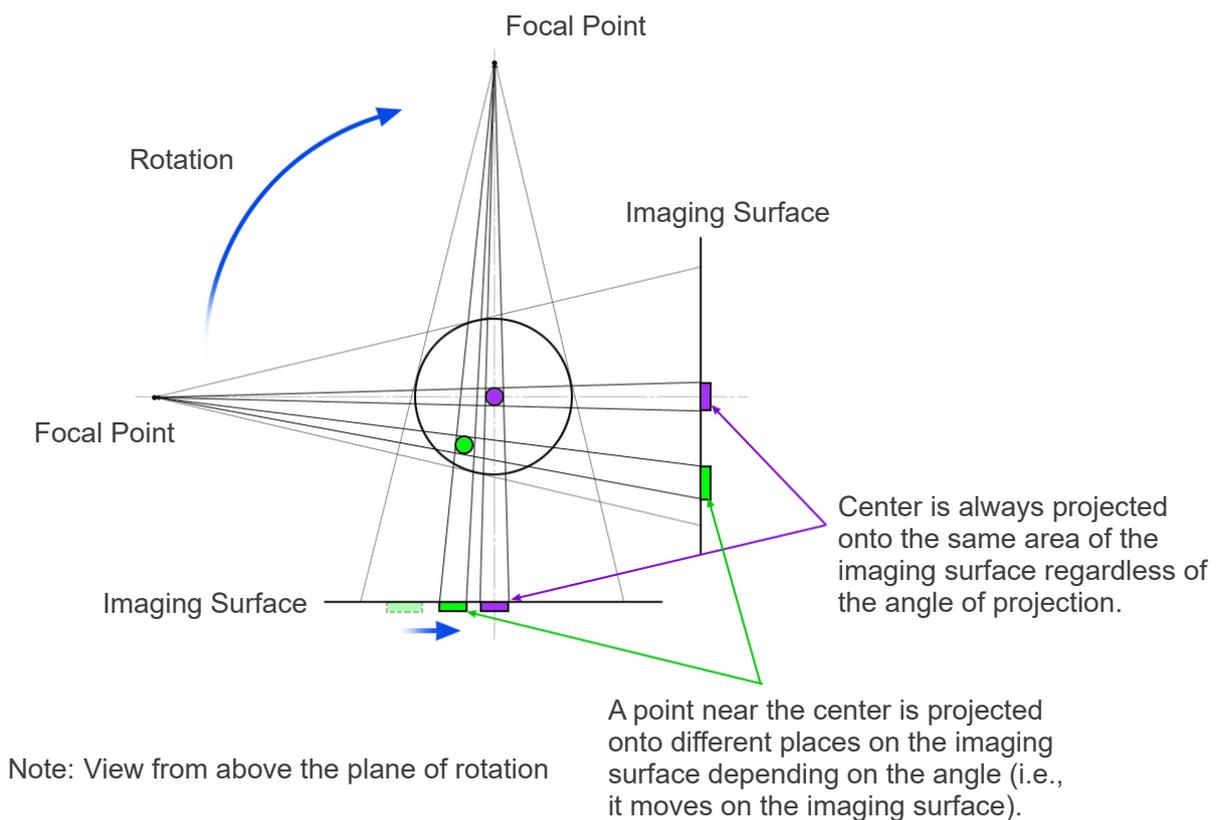

Fig. 1 Principle of CT Exposure

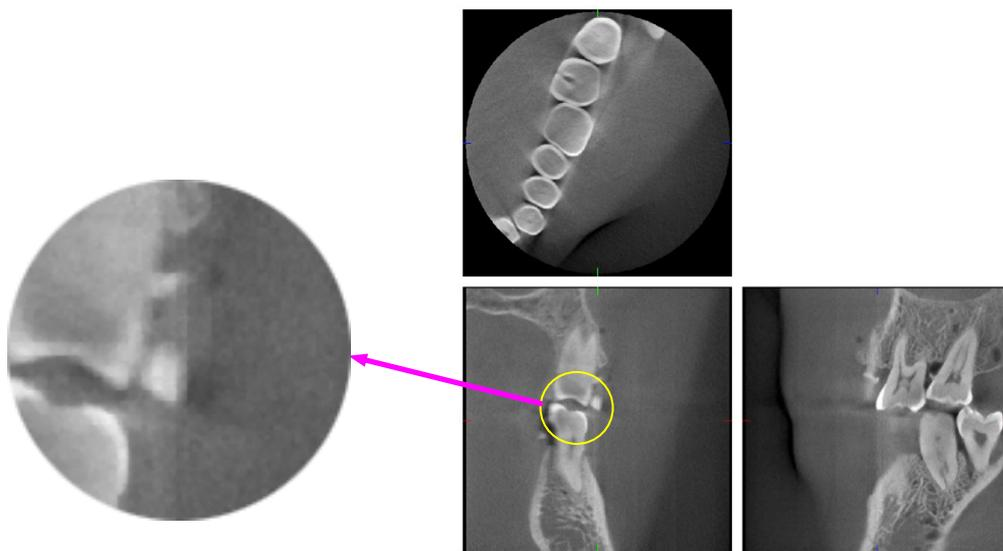

Fig. 2 Example of an Artifact

Artifacts due to Metal Prosthetics

Useful images may not be possible if a patient has metal fillings or prosthetic devices, and it is usually impossible to make a useful image of a crown if it is right next to a metal prosthetic.

Also it is sometimes impossible to make useful images of a root or jaw bone if there is a metal post, crown or other prosthetic right next to it.

Photos 3 through 9 were made of a mandible model with various metal prosthetics, posts and canal fillings to demonstrate what needs to be taken in consideration for accurate diagnosis and analysis.

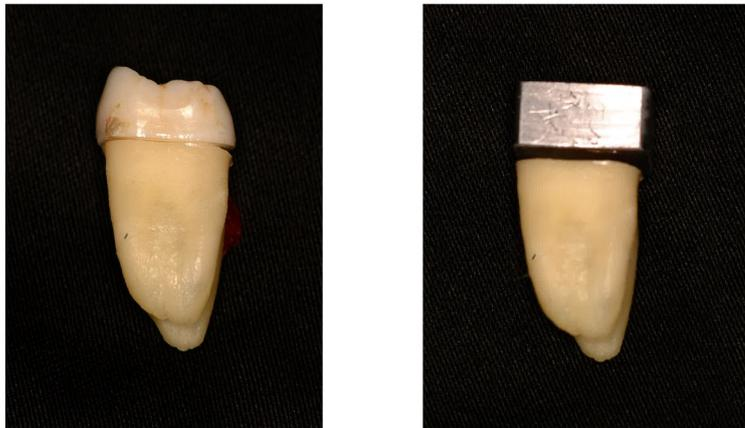
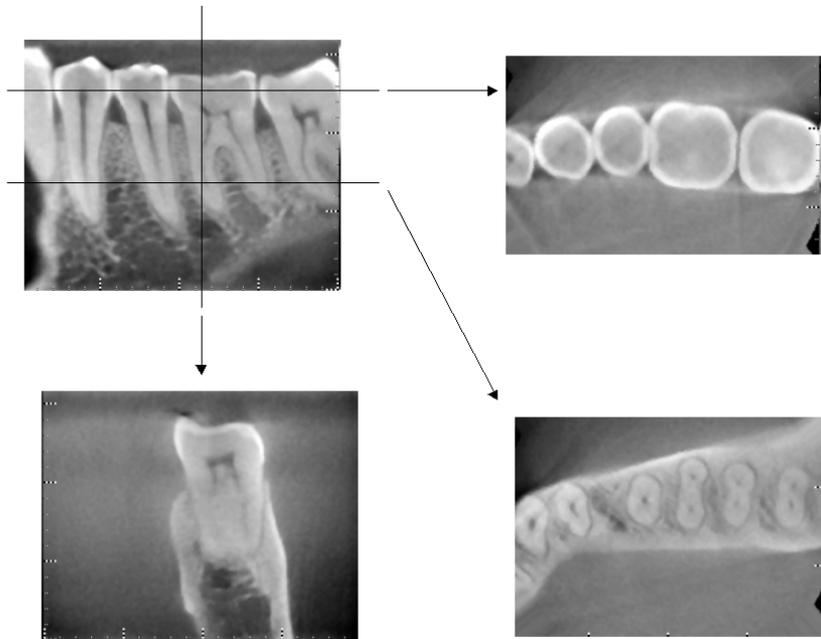
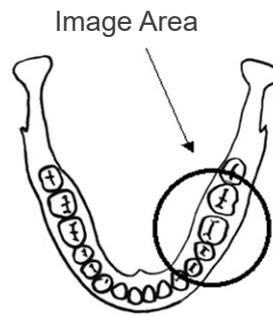
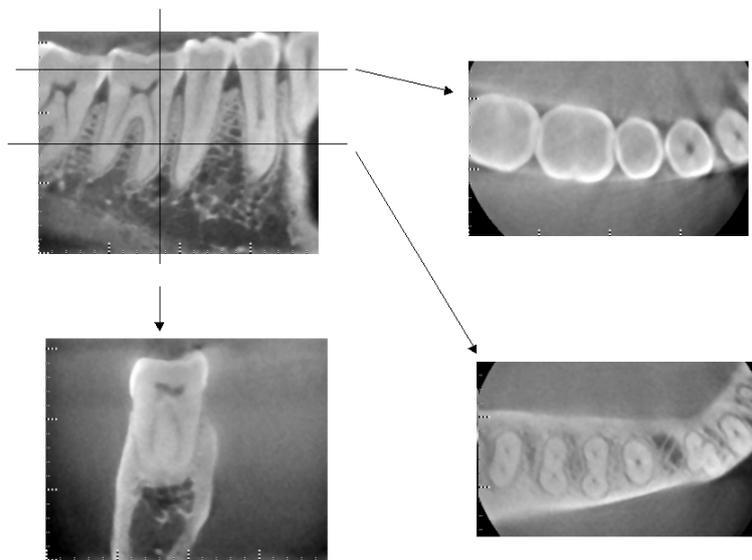
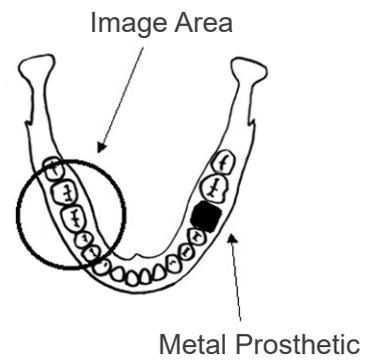

Photo 3 Model of full metal crown.
(Top of crown was removed and replaced with a piece of lead.)



Photos 4 No metal Prosthetic
(Top: Model and Image Area. Bottom: Images.)



Photos 5 Full metal crown is on the opposite side of the image area.
(Top: Model and Image Area. Bottom: Images.)

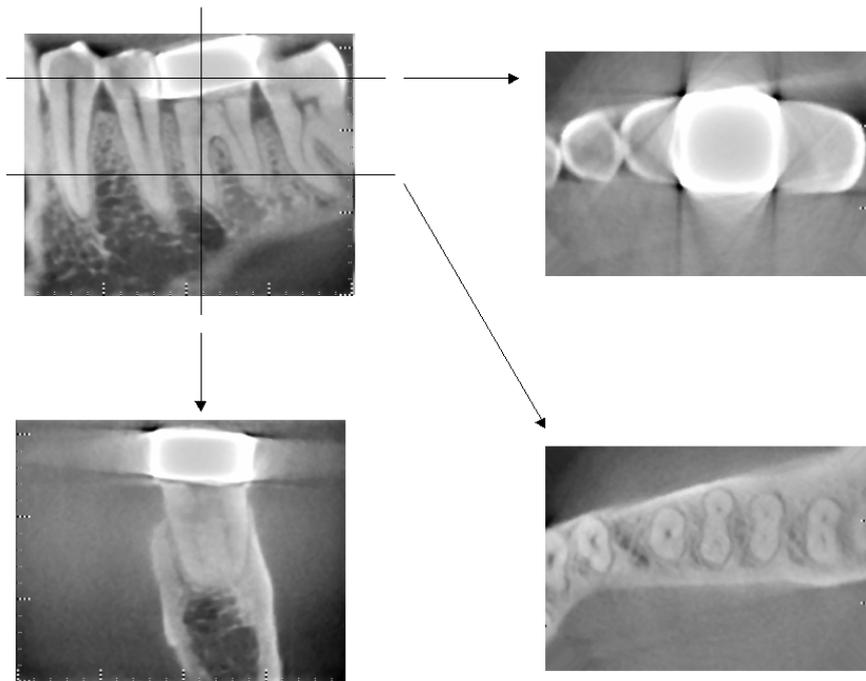
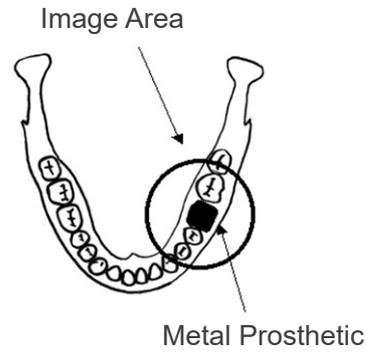

Photos 6 Imaging area on same side as metal crown
(Top: Model and Image Area. Bottom: Images.)



Photos 7 Post and Crown

Left: Post and Crown made after filling root canal with gutta percha and point.
Center: Post and Crown attached to tooth.
Right: Simple dental X-ray.

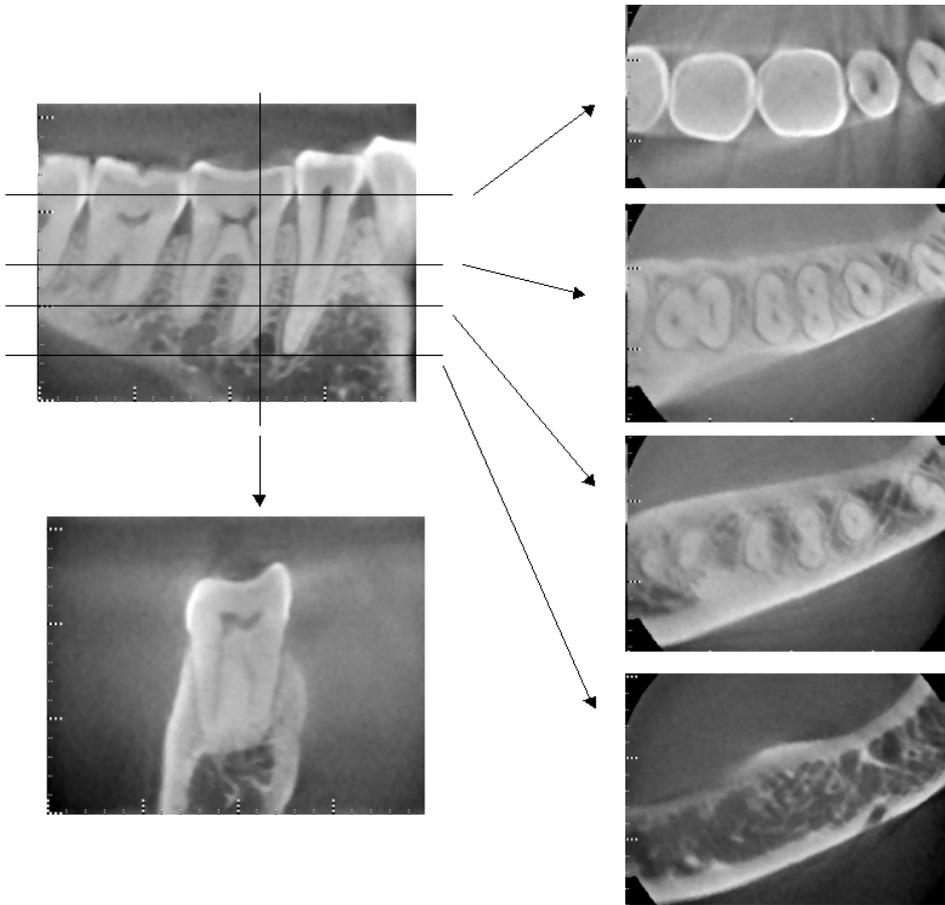
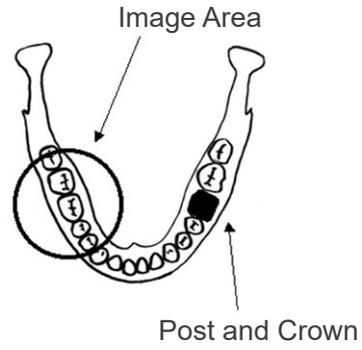

Photos 8 Image area on opposite side.
(Top: Model and Image Area. Bottom: Images.)

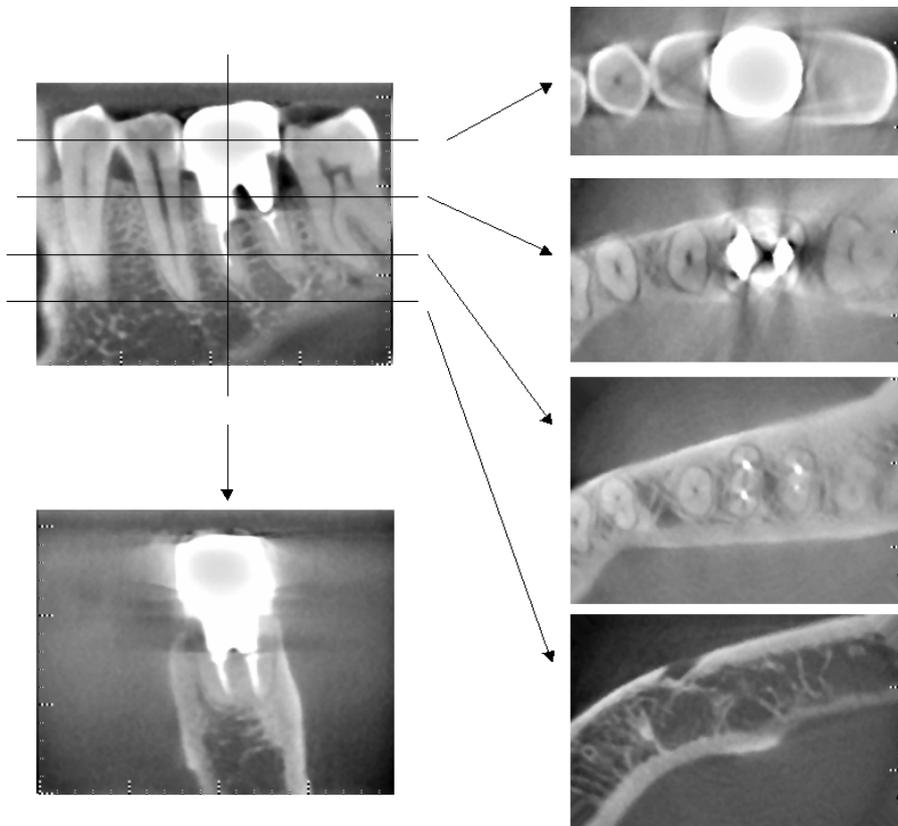
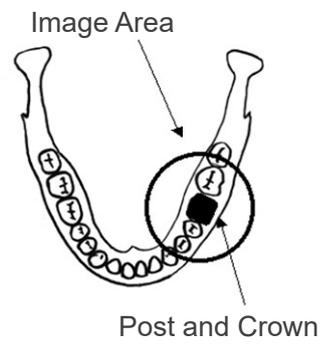

Photos 9 Image area on same side
 (Top: Model and Image Area. Bottom: Images.)

Artifacts for 180° Exposures

For 180° exposures, when the X-ray beam passes through the lower plane (a) in Figure 10, the result is the flat shape shown in Figure 11, where the beginning of 180° circuit matches the end of the circuit.

However, when the X-ray beam passes through the upper plane (b) in Figure 10, the result is the conical shape shown in Figure 12, where there is a discontinuity between the beginning and end of the circuit.

Therefore, some slight streaking appears in a 180° exposure that does not appear in a 360° exposure (Figure 13). These streaks run in the direction of the rotation. As a result, some semi-circular artifacts appear in the Z-plane image, and these must be recognized and taken into consideration for accurate diagnosis and analysis.

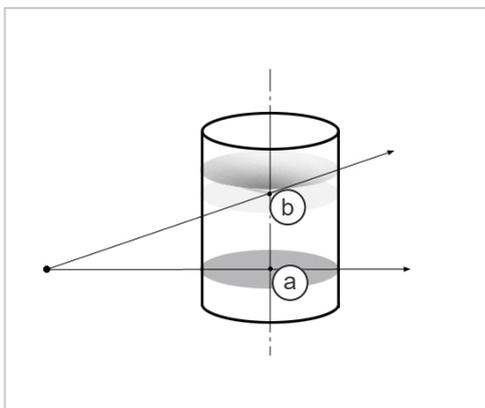

Fig. 10

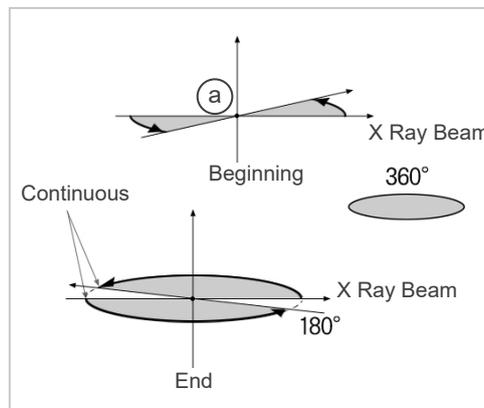

Fig. 11

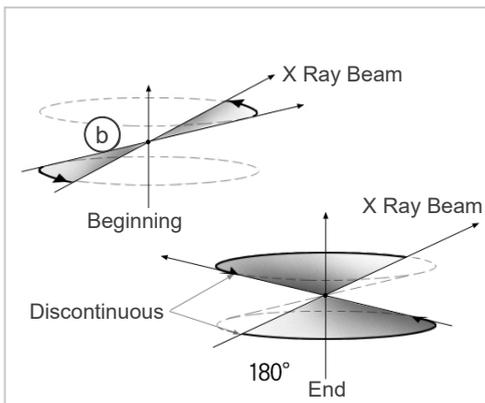

Fig. 12

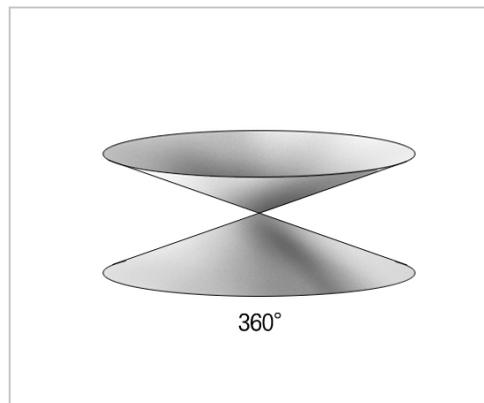

Fig. 13

7. Technical Description

Technical Description

Model	MCT-1
Type	EX-1 F17

Classification

European Directive 93/42/EEC	IIb (Rule 10)
Conforms to the safety standards:	IEC60601-1, IEC60601-1-1, IEC60601-1-2, IEC60601-1-3, IEC60601-1-4, IEC60601-1-6, IEC60601-2-7 IEC60601-2-28, IEC60601-2-32, IEC60601-2-44, ISO14971, ISO10993-1, ISO10993-5 and ISO10993-12, UL60601-1, CAN/CSA-C22.2 No.601.1-M90, FDA 21CFR Subchapter J (for U.S.A. only)
Protection against electric shock	CLASS I
Applied parts	TYPE B
Protection against ingress of liquids	IPX 0
Disinfection methods:	
- For each patient, all areas contacted by the patient's skin such as the head rest should be disinfected by wiping with disinfecting alcohol. Disposable paper sheets can be used for this purpose, also.	
- Occasionally, control panel, remote controller, headrest, seat and headband should be wiped with disinfecting alcohol, and LCD surface should be wiped with dry cloth.	
Mode of operation	Intermittent Stand-by is continuous
Laser Class	Class 2: Positioning Beams Class 1: Optical Interface

Product Description

Model: MCT-1 Type: EX (herein after MCT) is a limited cone-beam X-ray CT. MCT makes diagnosis possible with high resolution three-dimensional images for small lesions within a limited area of the extremely complex morphology of the hard tissue of the head and neck region.

High resolution images in the same short period as Panoramic Radiography. Low X-radiation dosage and Compact.

Intended use

MCT-1 type EX F is intended to be used for head and neck three dimensional X-ray Computed Tomography by a limited, cone-shaped X-ray beam projected onto a flat panel X-ray detector, to be operated and used by doctors, dentists, properly licensed professionals and other legally qualified professionals.

Applications include diagnosis for Temporal, Nasal, Orbita, Maxilla, Mandibula, Cerviales, Cranium and Basicranium area.

Essential Performance

Performance necessary to achieve freedom from unacceptable RISK.

- No unexpected X-ray irradiation
- No unexpected movement of the equipment

Generator/X-ray Head Assembly

Tube	D-051, Toshiba
Focal Spot	0.5
Target Angle	5°
Target Material	Tungsten
Scan Modes	Standard (Std) mode High Fidelity (Hi-Fi) mode (optional) High Resolution (Hi-Res) mode (optional) High Speed (Hi-Speed) mode (optional)
Operating Tube Potential	60–90 kV(accuracy of displayed values $\pm 10\%$)
Operating Tube Current	1–10 mA (accuracy of displayed values $\pm 10\%$) limited up to 8mA in Hi-Fi and Hi-Res modes
Maximum Output Power	0.9 kW nominal at 90kV, 10mA
Imaging Area Size	40 × 40 to 170 × 120 mm (Diameter × Height) limited up to 60 × 60 mm in Hi-Res and Hi-Speed modes
Filtration	Inherent filtration minimum 3.1 mm Al at 70 kV
Beam Quality (HVL)	min. 1.9 mmAl at 60 kV min. 2.1 mmAl at 70 kV min. 2.9 mmAl at 80 kV min. 3.2 mmAl at 90 kV
Primary Protective Shield	Minimum 1.0 mm Pb or equivalent
Outer Shell Temperature	45°C maximum
Duty Cycle	1:60, 90 kV/10 mA
Filament	Preheated
Rectification	Direct Current
Cooling	Oil and Forced Air Cooling
Maximum Heat Unit of X-ray Head Assembly	194.45 kJ (1 HU = 1.35 Joule)
Leakage Radiation	max. 1.0 mGy/h at 1 m
Minimum mAs	9.0 mAs

Power requirements

Input Voltage	120 VAC 50/60 Hz single phase, Permanent installation Voltage fluctuation shall be within $\pm 5\%$
Fuse (at the distribution panel)	20 A, 250 V, slow
Power Consumption	max. 2.0 kVA
Rated input amperes	max. 19 A (with operation) max. 3 A (stand by)
Power line resistance	max. 0.5 ohm

Mechanical parameters

SID	740–840 (± 20) mm (variable)
SOD (source-object)	540 (± 20) mm
SSD	200 (± 20) mm minimum
Outer Dimensions	
Main Unit	W 1,620 × D 1,200 × H 2,080 mm
Control Box	W 70 (96) × D 40 × H 115 mm
Vertical Height of Focal Spot	1,480 (± 20) mm
Weight of C-arm	approx. 70 kg
Patient Positioning	Positioned using 3 positioning beams and an electrically operated positioning system (Scout)

Exposure Time

Standard mode	17.5 sec (Full:360°) / 9.0 sec (Half:180°)
High Fidelity mode (optional)	30.8 sec (Full:360°) / 15.8 sec (Half:180°)
High Resolution mode (optional)	30.8 sec (Full:360°) / 15.8 sec (Half:180°)
High Speed mode (optional)	10.5 sec (Full:360°) / 5.4 sec (Half:180°)
Accuracy of displayed values	$\pm 10\%$
Emission Switch	Dead Man Type

CT Image Quality

Resolution	more than 2 lp/mm
------------	-------------------

Leakage technique factors

90kV, 600mAs/h (90kV, 10mA, duty cycle 1:60, for example 17.5s exposure per 17.2 minutes cool-down period)

Measurement bases

The tube voltage kV is measured by differentially monitoring the current flowing through 450 M Ω , 1% feedback resistors connected between the tube anode and ground. The tube current mA is measured by monitoring the current in the HT return line, which equals the tube current.

The exposure time. Starting point of exposure is determined at the time when the kV value reaches to 75% of the average kV. Termination of exposure is determined at the time when the kV value decreases to 75% of the average kV.

Emergency Stop Conditions

When the Emergency Stop is activated, the automated movements of the equipment will stop within the following distances:

Chair horizontal movements:	within 5 mm
Chair vertical movements:	within 5 mm
Arm rotation:	within 10 mm (at the side of the head assembly cover)

Environmental data

Operating Environments

Temperature	+10°C to +30°C (+50°F to +86°F)
Humidity	30% to 75% (without condensation)
Atmospheric Pressure	70 kPa to 106 kPa

Transport and Storage Environments

Temperature	-5°C to +43°C (+23°F to +109.4°F)
Humidity	8% to 85%
Atmospheric Pressure	70 kPa to 106 kPa

Original language English

Disposal

The package should be recycled. Metal parts of the equipment are disposed as scrap metal. Synthetic materials, electrical components, and printed circuit boards are disposed as electrical scrap. Material must be disposed according to the relevant national legal regulations. Consult specialized disposal companies for details. Please consult local city/community administrations concerning local disposal companies.



This symbol is affixed to fulfill the requirements of EU Directive 2002/92/ED Article 11.
This equipment cannot be disposed of as unsorted municipal waste within the European Union. Follow local regulations for disposal.
(for EU)

Service

- J. MORITA products may be repaired and serviced by:
- The technicians of J. MORITA's subsidiaries all over the world.
 - The technicians employed by authorized J. MORITA dealers and specially trained by J.MORITA.
 - Independent technicians specially trained and authorized by J. MORITA.

Collimator

MCT-1F17 Collimator - motorized variable collimator.

List of accessories

Description	Order No.	Description	Order No.
Support Seat	6311655	Headrest Cushions (large)	6311652
Child Seat	6311654	Headrest Cushions (small)	6311653
Head Band (A)	6311661	Headrest	6311662
Head Band (B)	6311651	Chinrest	6311650

Requirements for computers or other devices connected to the computers

1. MCT-1 has been tested and found to comply with the limits for medical devices to the IEC 60601-1-2 for electro magnetic compatibility. These limits are designed to provide reasonable protection against harmful interference in a typical medical installation. This equipment generates, uses, and can radiate radio frequency energy and, if not installed and used in accordance with the instructions, may cause harmful interference to other devices in the vicinity. However, there is no guarantee that interference will not occur in a particular installation. If this equipment does cause harmful interference to other devices, which can be determined by turning the equipment off and on, the user is encouraged to try to correct the interference by one or more of the following measures:
 - Reorient or relocate the receiving device.
 - Increase the separation between the equipment.
 - Connect the equipment into an outlet on a circuit different from that to which the other device(s) are connected.
 - Consult the nearest J. MORITA OFFICE, its representative or its dealer for help.
2. The following equipment connected to the analog and digital interfaces must be certified according to the respective IEC standards (i.e. IEC 60950-1 for data processing equipment and IEC 60601-1 for medical equipment). Furthermore all configurations shall comply with the system standard IEC 60601-1-1. Everybody who connects additional equipment to the signal input part or signal output part configures a medical system, and is therefore responsible that the system complies with the requirements of IEC 60601-1-1. If in doubt, consult the nearest J. MORITA OFFICE, its representative or its dealer for help.

Some of the following devices may cause some technical problems with 3D Accutomo.
Ask your nearest J. MORITA OFFICE for proper selection of equipment and connections.

Hardware

Windows based Personal Computer

CPU:	Pentium 4 3GHz or higher, or compatible.
Memory:	2GB or more
HDD:	HDD 120GB or more is recommended
Image Acquisition	Intel Pro 1000BASE-TX or SX NIC
Network:	100BASE-TX ×2 or adding equivalent NIC Connection MCT-1 main component 1 ch 1 ch serial communication (RS-232C)
CD/DVD Drive:	Recommended
OS:	Windows XP SP1 or later
Display:	17 inch CRT or TFT LCD / 16,000,000 colors (min)
Standard:	IEC60950-1 IEC60601-1 EMC regulation Related UL standard (U.S.) Related C-UL standard (Canada) Local regulations

Hub

10 Base-T, Non intelligent Shared HUB
Standard: IEC60950-1
IEC60601-1
EMC regulation
Related UL standard (U.S.)
Related C-UL standard (Canada)
Local regulations

Storage Device

DVD-RW burner is recommended as the data storage device.
Standard: IEC60950-1
IEC60601-1
EMC regulations
Related UL standard (U.S.)
Related C-UL standard (Canada)
Local regulations

Media Converter 1000BASE-TX/SX Gigabit Media Converter
Hobbes, HME2-1000 or equivalent

Other equipment connected to PC directly

Standard: IEC60950-1
IEC60601-1
EMC regulation
Related UL standard (U.S.)
Related C-UL standard (Canada)
Local regulations

Cables

RS-232C: Shielded crossover, 9-pin D-Sub, Female to male
Non-conductive connector housings required
Length less than 15 m
Optical Fiber: 2P, Multi-mode, Push-lock SC Connectors
Length less than 15 m

CAUTION

- ***Above devices may not be located in the X-ray protection area or the patient vicinity.***

* **The patient vicinity is the area where intentional or unintentional contact can occur between a patient or a patient's attendant and the above devices, or between a patient or a patient's attendant and other persons touching the above devices. This area extends 1.83 m beyond the perimeter of the bed (examination table, dental chair, treatment booth, and the like) in its intended location, and vertically 2.29 m above the floor.**

Application Software

Application software for image processing or database provided by J. MORITA. It shall be used with the above Windows base computer specifications.

It conforms to 93/42/EEC (EU), IEC60601-1-4 and 21 CFR (U.S.), Medical device regulations (Canada). If another software application is used, it must conform to the above regulations and standards, and must provide an interface which conforms to the 3DXD driver from J. MORITA MFG. CORP. Ask your nearest J. MORITA OFFICE for the appropriate interface.

Meaning of Symbols

* Some symbols may not be used.

	Manufacturer		Date of manufacture
	Refer to instructions for use		Alternating current
	Medical device		Unique device identifier
	CE(0197) marking Conforms with the European Directive, 93/42/EEC.		Equipotentiality Use this terminal when it is required to use potential equipotentialization conductors, do not use for protective earth connection.
	CE marking Conforms with the European Directive, 2011/65/EU.		
	Serial Number		EU authorized representative under the European Directive 93/42/EEC
	Emergency switch		Focal spot
	X-ray Emission Switch		Connection point for the neutral conductor
	Key switch Off		On
	Main switch Off		On
	Marking of electrical equipment in accordance with the European Directive 2012/19/EU (WEEE)		Type B applied part
	This way up		Fragile
	Keep away from rain		Temperature limitation
	Humidity limitation		Atmospheric pressure limitation
	In accordance with 21 CFR 801, U.S.A.		cTUVus certification mark (U.S.A. and Canada)
	Attention, consult accompany documents		GS1 DataMatrix
	Laser radiation		Class I equipment Classification for protection against electrical shock



Laser caution label

WARNING

This X-ray unit may be dangerous to patient and operator unless safe exposure factors, operating instructions and maintenance schedules are observed.

Explosion hazard: Do not use in presence of flammable anesthetics.

MISE EN GARDE

Cet appareil à rayons X peut présenter un danger pour le patient et l'opérateur, si les facteurs d'expositions qui ne présentent pas de danger, les instructions d'emploi et les programmes d'entretien ne sont pas respectés.

Risque d'explosion : ne pas utiliser en présence d'anesthésiants inflammables.

X-ray warning label

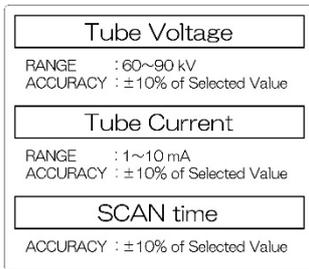

Accuracy label



X-ray warning / Laser caution (Canada)

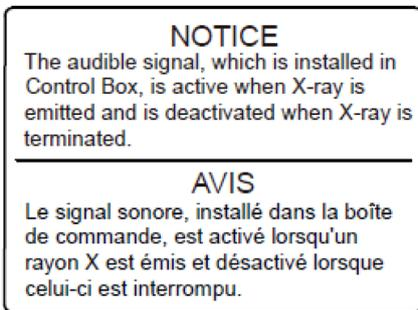

Audible signal label

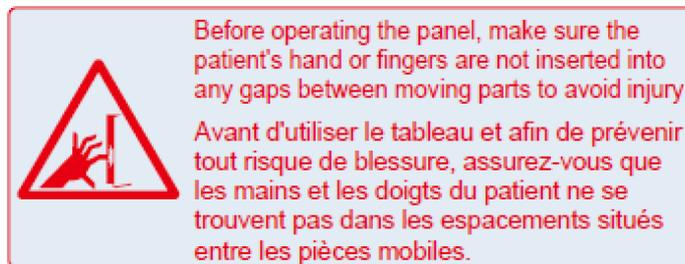

Caution label



Chinrest warning label

Tube Housing Assembly Information

Heating Curve

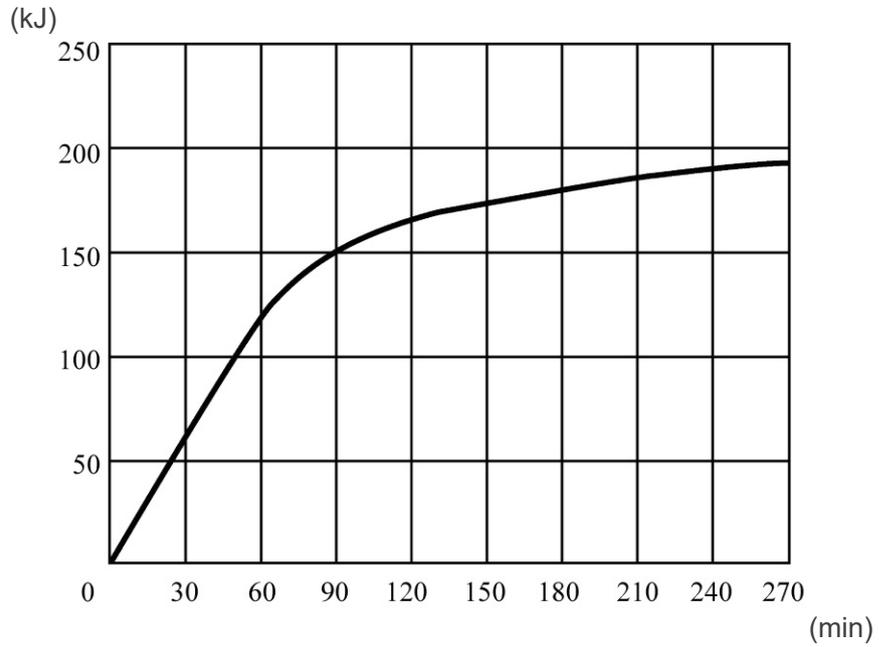

Cooling Curve

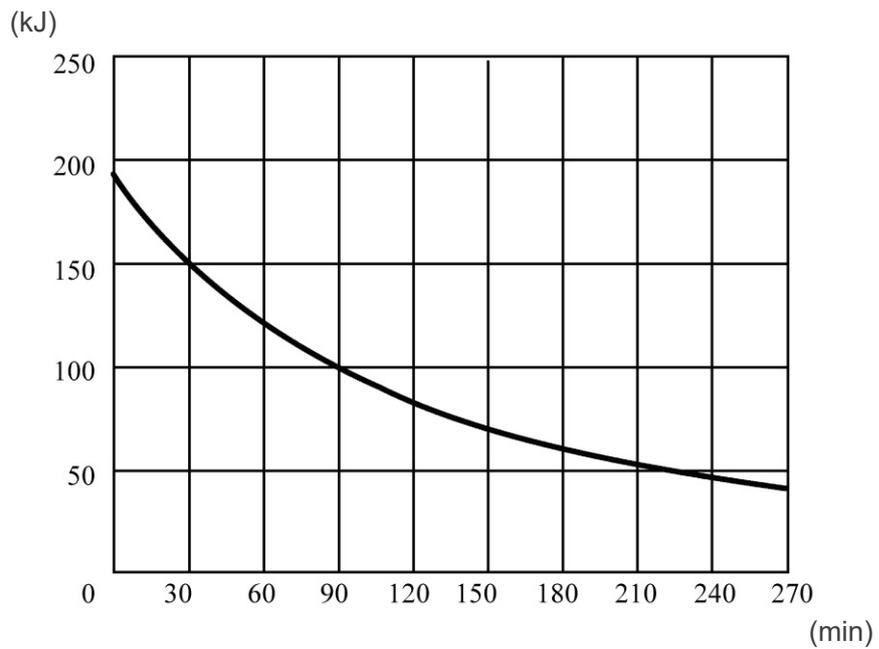

Tube Rating Chart

Maximum Rating Chart
(Absolute Maximum Rating Charts)

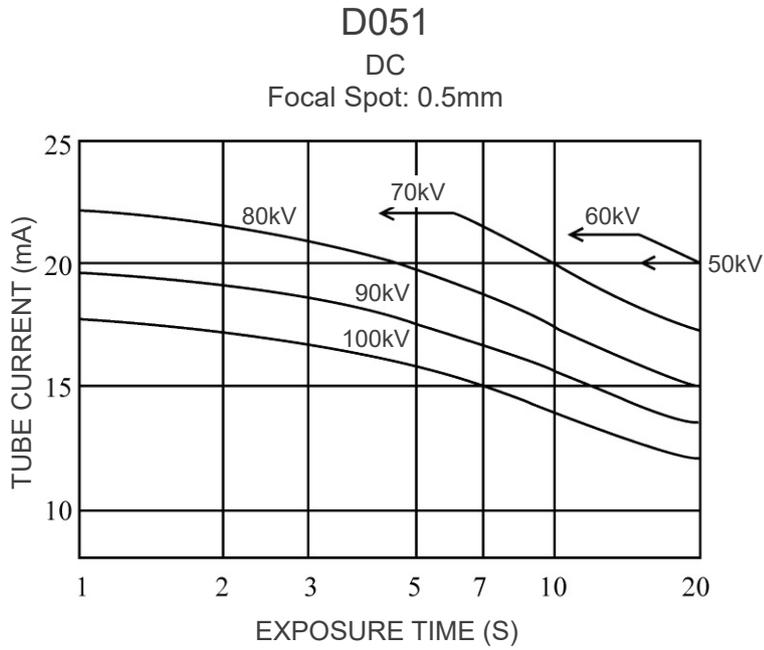

Anode Thermal Characteristics

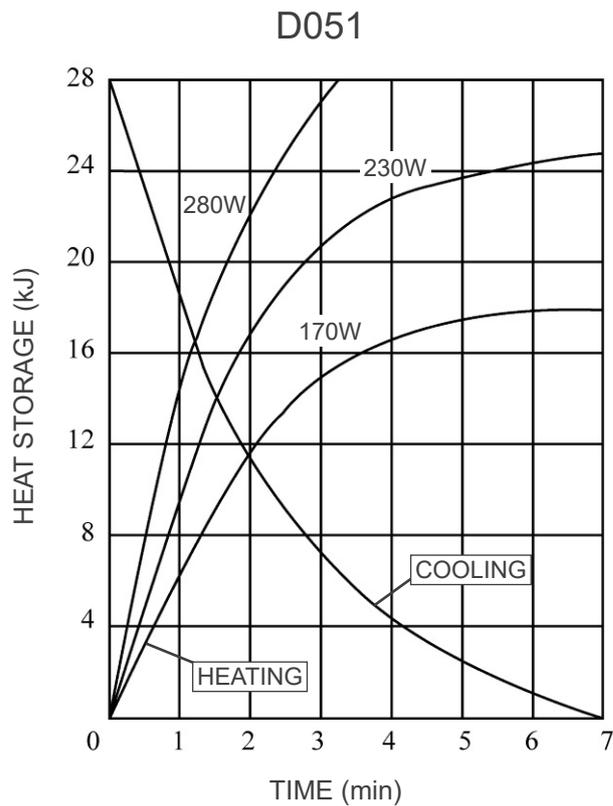

Reference Axis of the X-ray Field

170×120 Mode Dimensions

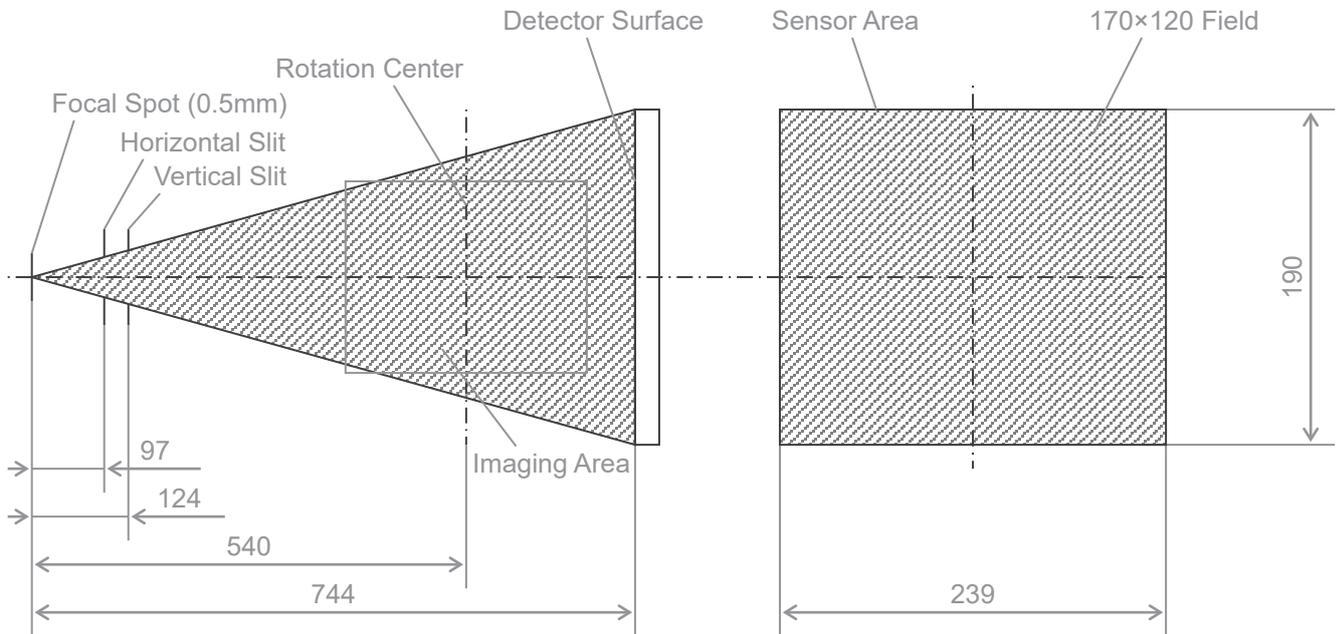

40×40 - 140×100 Mode Dimensions

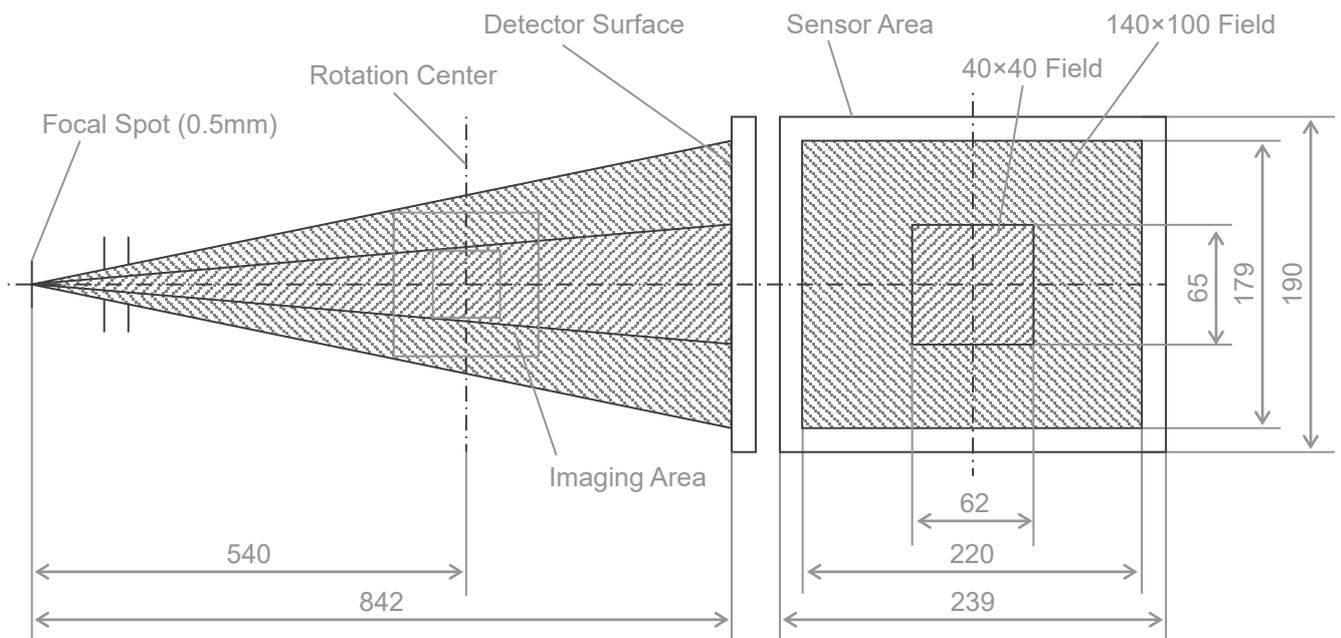

List of Replacement Parts

Replacement Parts

Parts	Description	Code No.
Main Fuse	T 20 A 250 V Slow, High Breaking Capacity	6370070
Power Board Fuse(FH1)	F 10 A 400 V Fast-acting, High Breaking Capacity, Ceramic type	6310324
Power Board Fuse(FH2)	F 2 A 250 V Fast-acting, High Breaking Capacity, Ceramic type	6370090
Isolation Board Fuse	F 200 mA 250 V Fast-acting, High Breaking Capacity, Glass type	6370100
Switching Fuse	F 10 A 400 V Fast-acting, High Breaking Capacity, Ceramic type	6310324

Fuse shall conform to IEC 60127. For the Main Fuse, please verify the MCT-1 type before changing.

8. Appendix – Electromagnetic Declaration

Guidance and Manufacturer's Declaration – Electromagnetic Emissions		
<p>The 3D Accuitomo (hereinafter referred to as "the MCT-1") is intended for use in the electromagnetic environment specified below. The customer or the user of the MCT-1 should assure that it is used in such an environment.</p>		
Emissions Test	Compliance	Electromagnetic Environment – Guidance
RF emissions CISPR 11	Group 1	The MCT-1 uses RF energy only for its internal function. Therefore, its RF emissions are very low and are not likely to cause any interference in nearby electronic equipment.
RF emissions CISPR 11	Class B	The MCT-1 is suitable for use in all establishments, including domestic establishments and those directly connected to the public low-voltage power supply network that supplies buildings used for domestic purposes.
Harmonic emissions IEC61000-3-2	Class A	
Voltage fluctuations/flicker emissions IEC 61000-3-3	Complies	

Guidance and Manufacturer's Declaration – Electromagnetic Immunity			
The MCT-1 is intended for use in the electromagnetic environment specified below. The customer or the user of the MCT-1 should assure that it is used in such an environment.			
Immunity Test	IEC 60601 Test Level	Compliance Level	Electromagnetic Environment – Guidance
Electrostatic discharge (ESD) IEC 61000-4-2	±6 kV contact ±8 kV air	±6 kV contact ±8 kV air	Floors should be wood, concrete or ceramic tile. If floors are covered with synthetic material, the relative humidity should be at least 30 %.
Electrical fast transients/bursts IEC 61000-4-4	±2 kV for power supply lines ±1 kV for input/output lines	±2 kV for power supply lines ±1 kV for input/output lines	Mains power quality should be that of a typical commercial or hospital environment.
Surge IEC 61000-4-5	±1 kV line(s) to line(s) ±2 kV line(s) to earth	±1 kV line(s) to line(s) ±2 kV line(s) to earth	Mains power quality should be that of a typical commercial or hospital environment.
Voltage dips, short interruptions and voltage variations on power supply lines IEC 61000-4-11	<5% U_T (>95% dip in U_T) for 0.5 cycle 40% U_T (60% dip in U_T) for 5 cycles 70% U_T (30% dip in U_T) for 25 cycles <5% U_T (>95% dip in U_T) for 5 sec	<5% U_T (>95% dip in U_T) for 0.5 cycle 40% U_T (60% dip in U_T) for 5 cycles 70% U_T (30% dip in U_T) for 25 cycles <5% U_T (>95% dip in U_T) for 5 sec	Mains power quality should be that of a typical commercial or hospital environment. If user of the MCT-1 requires continued operation during power mains interruptions, it is recommended that the MCT-1 be powered from an uninterruptible power supply or a battery.
Power frequency (50/60 Hz) magnetic field IEC 61000-4-8	3 A/m	3 A/m	Power frequency magnetic field should be at levels characteristic of a typical location in a typical commercial or hospital environment.
Note U_T is the a.c. mains voltage prior to application of the test level.			

Guidance and Manufacturer’s Declaration – Electromagnetic Immunity

The MCT-1 is intended for use in the electromagnetic environment specified below. The customer or the user of the MCT-1 should assure that it is used in such an environment.

Immunity Test	IEC 60601 Test Level	Compliance Level	Electromagnetic Environment – Guidance
<p>Conducted RF IEC 61000-4-6</p> <p>Radiated RF IEC 61000-4-3</p>	<p>3 Vrms 150 kHz to 80 MHz</p> <p>3 V/m 80 MHz to 2.5 GHz</p>	<p>3 V</p> <p>3 V/m</p>	<p>Portable and mobile RF communications equipment should be used no closer to any part of the MCT-1, including cables, than the recommended separation distance calculated from the equation applicable to the frequency of the transmitter.</p> <p>Recommended separation distance</p> $d = 1.2 \sqrt{P}$ $d = 1.2 \sqrt{P} \quad 80 \text{ MHz to } 800\text{MHz}$ $d = 2.3 \sqrt{P} \quad 800\text{MHz to } 2.5 \text{ GHz}$ <p>Where P is the maximum output power rating of the transmitter in watts (W) according to the transmitter manufacturer and d is the recommended separation distance in meters (m).</p> <p>Field strengths from fixed RF transmitters, as determined by an electromagnetic site survey, ^a should be less than the compliance level in each frequency range. ^b</p> <p>Interference may occur in the vicinity of equipment marked with the following symbol:</p> 

NOTE 1: At 80 MHz and 800 MHz, the higher frequency range applies.

NOTE 2: These guidelines may not apply in all situations. Electromagnetic propagation is affected by absorption and reflection from structures, objects and people.

^a Field strengths from fixed transmitters, such as base stations for radio (cellular/cordless) telephones and land mobile radios, amateur radio, AM and FM radio broadcast and TV broadcast cannot be predicted theoretically with accuracy. To assess the electromagnetic environment due to fixed RF transmitters, an electromagnetic site survey should be considered. If the measured field strength in the location in which the MCT-1 is used exceeds the applicable RF compliance level above, the MCT-1 should be observed to verify normal operation. If abnormal performance is observed, additional measures may be necessary, such as reorienting or relocating the MCT-1.

^b Over the frequency range 150 kHz to 80MHz, field strengths should be less than 3 V/m.

Recommended Separation Distances between Portable and Mobile RF Communications Equipment and the MCT-1.

The MCT-1 is intended for use in an electromagnetic environment in which radiated RF disturbances are controlled. The customer or the user of the MCT-1 can help prevent electromagnetic interference by maintaining a minimum distance between portable and mobile RF communications equipment (transmitters) and the MCT-1 as recommended below, according to the maximum output power of the communications equipment.

Rated Maximum Output Power of Transmitter W	Separation Distance according to Frequency of Transmitter m		
	150 kHz to 80 MHz $d = 1.2 \sqrt{P}$	80 MHz to 800 MHz $d = 1.2 \sqrt{P}$	800 MHz to 2.5 GHz $d = 2.3 \sqrt{P}$
0.01	0.12	0.12	0.23
0.1	0.38	0.38	0.73
1	1.2	1.2	2.3
10	3.8	3.8	7.3
100	12	12	23

For transmitters rated at a maximum output power not listed above, the recommended separation distance d in meters (m) can be estimated using the equation applicable to the frequency of the transmitter, where P is the maximum output power rating of the transmitter in watts (W) according to the transmitter manufacturer.

NOTE 1: At 80 MHz and 800 MHz, the separation distance for the higher frequency range applies.

NOTE 2: These guidelines may not apply in all situations. Electromagnetic propagation is affected by absorption and reflection from structures, objects and people.



Development and Manufacturing

J. MORITA MFG. CORP.

680 Higashihama Minami-cho, Fushimi-ku, Kyoto 612-8533, Japan
T +81. (0)75. 611 2141, F +81. (0)75. 622 4595

Morita Global Website
www.morita.com

Distribution

J. MORITA CORP.

3-33-18 Tarumi-cho, Suita-shi, Osaka 564-8650, Japan
T +81. (0)6. 6380 1521, F +81. (0)6. 6380 0585

J. MORITA USA, INC.

9 Mason, Irvine CA 92618, USA
T +1. 949. 581 9600, F +1. 949. 581 8811

J. MORITA EUROPE GMBH

Justus-von-Liebig-Strasse 27b, 63128 Dietzenbach, Germany
T +49. (0)6074. 836 0, F +49. (0)6074. 836 299

MORITA DENTAL ASIA PTE. LTD.

150 Kampong Ampat #06-01A KA Centre, Singapore 368324
T +65. 6779. 4795, F +65. 6777. 2279

J. MORITA CORP. AUSTRALIA & NEW ZEALAND

Suite 2.05, 247 Coward Street, Mascot NSW 2020, Australia
T +61. (0)2. 9667 3555, F +61. (0)2. 9667 3577

J. MORITA CORP. MIDDLE EAST

4 Tag Al Roasaa, Apartment 902, Saba Pacha 21311 Alexandria, Egypt
T +20. (0)3. 58 222 94, F +20. (0)3. 58 222 96

J. MORITA CORP. INDIA

Filix Office No.908, L.B.S. Marg, Opp. Asian Paints, Bhandup (West), Mumbai 400078, India
T +91-82-8666-7482

J. MORITA MFG. CORP. INDONESIA

28F, DBS Bank Tower, Jl. Prof. Dr. Satrio Kav. 3-5, Jakarta 12940, Indonesia
T +62-21-2988-8332, F + 62-21-2988-8201

SIAMDENT CO., LTD.

71/10 Moo 5 T. Tharkham A. Bangpakong Chachuengsao 24130 Thailand
T +66 (0) 3857 3042, F +66 (0) 3857 3043
www.siamdent.com

EU Authorized Representative under the European Directive 93/42/EEC



Medical Technology Promedt Consulting GmbH

Ernst-Heckel-Straße 7, 66386 St. Ingbert, Germany T +49. 6894 581020, F +49. 6894 581021

The authority granted to the authorized representative, Medical Technology Promedt Consulting GmbH, by J. MORITA MFG. CORP. is solely limited to the work of the authorized representative with the requirements of the European Directive 93/42/EEC for product registration and incident report.

Diagnostic and Imaging Equipment

Treatment Units

Handpieces and Instruments

Endodontic Systems

Laser Equipment

Laboratory Devices

Educational and Training Systems

Auxiliaries