



Apex Locator, Canal Preparation and Light Cure

DENTAPORT ZX

Canal Preparation and Light Cure Module

(OTR compatible)



INSTRUCTIONS FOR USE

- * DENTAPORT ZX Canal Preparation and Light Cure Module (Optimum Torque Reverse compatible) must be connected to the DENTAPORT ZX Canal Measurement Module, which is sold separately.

This unit cannot be used as an independent unit.

This manual is for the Canal Preparation and Light Cure Module (OTR compatible).
To measure a canal refer to the manual for the Canal Measurement Module.



CE
0197



Thank you for purchasing the DENTAPORT ZX Canal Preparation and Light Cure Module (OTR compatible). For optimum safety and performance, read this manual thoroughly before using the unit and pay close attention to warnings and notes. Keep this manual in a readily accessible place for quick and easy reference. This manual contains essential safety information.

Trademarks (™) and Registered Trademarks (®):
The names of companies, products, services, etc. used in this manual are either trademarks or registered trademarks owned by each company.

CONTENTS

	Page
1. Prevent Accidents	1
2. Parts Identification	9
3. Assembling the Unit	11
Attaching Canal Preparation and Light Cure Module to Canal Measurement Module.....	11
Charging Battery	12
4. Before Using the Unit	13
Canal Preparation (see page 18 for Light Cure).....	13
Attaching Handpiece Cord	13
Assembling Motor Handpiece	14
Assembling File and File Electrode.....	15
Attaching Contrary Electrode.....	15
Attaching Foot Switch.....	16
Calibration.....	16
Checking the Function.....	17
Light Cure	18
Attaching Handpiece Cord	18
Connect the Light Cure Handpiece.....	19
5. Operating the Unit	20
Canal Preparation (see page 38 for Light Cure).....	20
<OTR Mode>	20
<Normal Mode>.....	21
Root Canal Measurement (Two Methods).....	22
Preparing the Root Canal.....	23
Liquid Crystal Display and Switches	24
<OTR Mode>	24
<Normal Mode>	26
Setting Memories for Other Functions	28
<OTR Mode>	28
<Normal Mode>	29
Meter Display	30
Operating the Motor Handpiece	31
Manual Mode Using the Foot Switch.....	34
Manual Mode Using the Operation Switches.....	35
Replace Built-in Electrode with Cap with External File Electrode	36
Light Cure	38
Overview of Features and Functions	38
Liquid Crystal Display and Switches	39
Setting and Changing Memory	40
Operation	41
6. After Using the Unit	43
7. Maintenance	45
a. Autoclavable Components.....	45
b. Non-Autoclavable Components: Wipe with Ethanol	50
c. Non-Autoclavable Components: Wash and then Wipe with Ethanol	51
d. Non-Autoclavable Components: Wipe with Neutral Detergent and Moistened Cloth.....	52
8. Replacement Parts, Transportation and Storage	55
Replace the built-in electrode	55
Replacing the Battery	56
9. Inspection	57
10. Troubleshooting	58
11. Technical Description	60
Appendix- Electromagnetic declaration	66

1. Prevent Accidents

Most operation and maintenance problems result from insufficient attention being paid to basic safety precautions and not being able to foresee the possibilities of accidents. Problems and accidents are best avoided by foreseeing the possibility of danger and operating the unit in accordance with the manufacturer's recommendations.

First thoroughly read all precautions and instructions pertaining to safety and accident prevention; then, operate the equipment with the utmost caution to prevent either damaging the equipment itself or causing bodily injury.

Note the meaning of the following symbols and expressions:



This warns that it may result serious injury of the patient or operator if the instructions are not followed properly.



The user can not use in such a way that may result in serious injury of the patient or operator.



This alerts the user to the possibility of damage to the equipment, potential injury of the patient or operator, or important points concerning operation and performance.

The user (e.g. the hospital, clinic etc.) is the party responsible for the maintenance and proper operation of a medical device.

Medical devices must only be operated by dentists and other legally licensed professionals.

Do not use this equipment for anything other than its specified purpose.

To access the warranty information for this product, scan the following QR code and visit our website.



- The useful life of the DENTAPORT ZX is 6 years from the date of installation provided it is regularly and properly inspected and maintained.
- J. MORITA MGF. CORP. will supply replacement parts and be able to repair the product for a period of 10 years after the manufacture of the product has been discontinued. For the duration of this period, we will supply replacement parts and be able to repair the product.

WARNING

- *No modification of this equipment is allowed.*
- *This unit must not be connected to or used in combination with any other apparatus or system. It must not be used as an integral component of any other apparatus or system. J. MORITA MGF. CORP. will not be responsible for accidents, equipment damage, bodily injury or any other trouble which results from ignoring this prohibition.*
- *Do not injure your fingers when inserting or removing files.*
- *Do not use damaged file holders; an accurate measurement can not be made with a damaged file holder.*
- *When continuous tone is heard while the main POWER switch is on and without any operation, some electrical part may be malfunction. Do not use the unit and send the unit to J. MORITA OFFICE for repairing.*
- *A rubber dam should be used when performing endodontic treatment.*
- *Caution: US Federal law restricts this unit to sale by or on the order of a dentist in U.S.A.*
- *The DENTAPORT ZX needs special precaution regarding EMC and needs to be installed and put into service according to the EMC information provided in the Accompanying Documents.*
- *Portable and mobile RF communications equipment can affect the DENTAPORT ZX.*
- *The DENTAPORT ZX should not be used adjacent to or stacked with other equipment and that if adjacent or stacked use is necessary, the DENTAPORT ZX should be observed to verify normal operation in the configuration in which it will be used.*
- *Never use stretched, deformed or damaged files. (see page 15)*
- *Give the file a light tug to confirm it is securely held in place. If the file is not securely placed, it could come out and injure the patient. (see page 15)*
- *Make sure the screw is properly tightened up. It could come out and be swallowed if it is loose; also canal measurements may not be accurate. (see page 15)*
- *Check the DENTAPORT ZX's operation before each patient. If the indicators in the display do not all appear normally, the instrument may not be able to make an accurate measurement. In this case, stop using the instrument and have it repaired. (see page 17)*
- *Do not let the light strike any one in the eye. Also do not look directly at the light or continuously at the area being irradiated; this could damage your eyesight. (see page 19)*
- *If there is a lightning storm while the battery is being charged, do not touch the main unit, the AC adapter or the main power cord; you could get a shock. (see page 20, 38)*
- *Make sure that the contrary electrode, file holder, handpiece file electrode etc., do not come into contact with an electric power source such as an electrical socket. This could result in a severe electrical shock. (see page 22, 31)*
- *Before measuring length of a root canal, make sure that the rotation speed does not appear on the display. If the rotation speed appears on the display, the unit is set for root canal preparation mode, and the handpiece will start running. This could result in an injury. (see page 22)*
- *Make sure the speed is not being displayed when measuring the length of the root canal. (see page 24, 26)*
- *Check the settings displayed after selecting memories. (see page 25, 27, 40)*
- *In some cases such as a blocked root canal, a measurement can not be made. (see page 30)*
- *Accurate measurement is not always possible, especially in cases of abnormal or unusual root canal morphology; make sure to take an X-ray to check the measurement results. (see page 30)*
- *Stop using the unit immediately if it does not seem to be working properly. (see page 30)*
- *If the indicator bar for the canal length does not appear even when the file is inserted, the unit may be malfunctioning and must not be used. (see page 30)*
- *Do not use an ultrasonic scaler with the contrary electrode attached to the patient. This is dangerous because electrical noise from the scaler could interfere with canal measurements and motor operation. (see page 31)*
- *If the motor overheats, take the handpiece out of the patient's mouth immediately, and wait until it cools down to resume treatment. Do not leave it inside the patient's mouth; this could result in an injury because it might start running unexpectedly when it cools down. (see page 32)*

WARNING

- *Electric noise or a malfunction could make it impossible to control the motor properly. Do not depend entirely on the unit controlling itself; always watch the display, listen to the sound and be aware of tactile feedback. (see page 33)*
- *Accurate measurement is not always possible depending on the root canal condition. Make sure to take an X-ray to check the results. Also nickel-titanium files can sometimes wear out rather quickly depending on the shape and the degree of curvature of the root canal. Stop using the unit immediately if it does not seem to be working properly. (see page 33)*
- *If the display does not change when the file is advanced down the canal, stop using the instrument immediately. There times, such as faulty connections etc. when an accurate measurement cannot be made. (see page 33)*
- *Nickel-Titanium files are more easily broken by the amount of torque applied to them than stainless steel files. Do not try to force the file down the root canal. Also do not use these files for the root canals that have a relatively sharp curve near the apical foramen. (see page 33)*
- *Nickel-Titanium files will eventually break due to metal fatigue and should be replaced before they reach this point. (see page 33)*
- *Always examine files for separation and other deformities or damage before using them. Any type of deformity could result in the file breaking. (see page 33)*
- *If the file touches the oral mucosa or a tooth, it will automatically start to rotate and could injure the patient. (see page 33)*
- *Do not touch the oral mucosa with the metal part at the end of the contra angle. The motor handpiece could start up and injure the patient or the instrument might not make accurate measurements. (see page 33)*
- *If the contra angle's file release button is pressed against the teeth opposite the one being treated, the file could come out and injure the patient. (see page 33)*
- *Never press the file release button while the motor handpiece is running. This could cause the button to heat up and burn the patient or cause the file to come out and injure the patient. (see page 33)*
- *Some files cannot use the built-in electrode to make measurement; always check for conductivity before using a file. If there is no conductivity, replace the cap with the one with an external file electrode. (see page 33)*
- *Do not use reciprocal files (ones made to rotate back and forth). These could perforate the apical foramen when they reverse rotation. (see page 33)*
- *Be careful using the foot switch. The motor will rotate even if a measurement is not being made. Make sure of the position of the file tip before using the foot switch. (see page 34)*
- *Make sure the screw is tight enough. Otherwise, it might come out and be swallowed. Also, measurements might not be accurate. (see page 36, 37, 54, 55)*
- *Make sure the file goes all the way in. Give it a light tug to make sure it is held securely. (see page 37)*
- *Never use stretched or otherwise damaged files. (see page 37)*
- *Replace the external file electrode if it is worn out as shown in the photo to the left. (see page 37)*
- *For effective infection control, do not fail to use a disposable cover. A new, uncontaminated disposable cover must be used for each patient to prevent from cross-contamination. Make sure it is not torn or damaged. Covers also protect the patient from swallowing chips etc. In case the glass is damaged. (see page 41)*
- *Never shine the light into the patient's eye. Never stare at the area being irradiated. Either of these actions could harm the eyesight. (see page 41)*
- *Ask the patient if the light is too hot. If the patient complains, hold the light a little farther away. (see page 42)*
- *Take care not to bump or bang the glass against a hard object. It might crack and a fragment could be swallowed by accident. Never use the light if the glass is cracked or chipped. (see page 42)*
- *Do not use the unit when the AC adapter is connected. (see page 44)*
- *Never operate the unit with an external power supply. (see page 44)*
- *If an electrical storm occurs while the battery is being charged, do not touch the AC adapter or the charger's power supply cord as there would be a risk receiving an electric shock. (see page 44)*

WARNING

- *The AC adapter must be located outside the so called patient environment (2.0m around the patient location) when the AC adapter is connected. (see page 44)*
- *Autoclave the contra angle and contrary electrode after each patient. (see page 45)*
- *Never direct the spray towards a person. (see page 47)*
- *Never use the spray near an open flame. (see page 47)*
- *Prevent spray from splashing into your eyes etc. by always covering the contra angle with gauze etc. (see page 47)*
- *Use of the parts other than those accompanied or specified by J. MORITA MGF. CORP. may result in increased EMC emissions or decreased EMC immunity of the DENTAPORT ZX. (see page 69)*

PROHIBITION

- *Do not use this unit in conjunction with an electric scalpel or on patients who have a pacemaker.*
- *Do not use this unit in the medical operation room.*
- *Blocked canals cannot be accurately measured.*
- *This unit must not be connected to or used in combination with any other apparatus or system. It must not be used as an integral component of any other apparatus or system. J. MORITA MGF. CORP. will not be responsible for accidents, equipment damage, bodily injury or any other trouble which results from ignoring this prohibition.*
- *Illumination devices such as fluorescent lights and the Film viewer which use an inverter can cause the DENTAPORT ZX to operate erratically. Do not use the DENTAPORT ZX near devices such as these.*
- *Electromagnetic wave interference could cause this unit to operate in an abnormal, random and possibly dangerous manner. Cellular phone, transceivers, remote controls and all other devices which transmit electromagnetic waves located inside the building should be turned off.*

CAUTION

- *If the catch on the bottom is not back in its original place after attachment, push it in the direction shown by the arrow in the illustration. (see page 12)*
- *After installation, give the Canal Preparation and Light Cure Module a light tug to confirm it is securely attached. (see page 12)*
- *The battery is not charged when the unit is shipped from the factory and must be charged before using the unit. (see page 12)*
- *Handle the Canal Preparation and Light Cure Module carefully; do not drop, bump or expose the unit to other kinds of impacts or shocks. Rough handling could cause damage. (see page 13, 18)*
- *Make sure the plug is all the way in; otherwise there could be measurement, operation or display problems. (see page 13)*
- *Do not drop anything on or bang the plug after it has been inserted into the jack. (see page 13, 18)*
- *Sliding the cord clips with too much force could cause the tube to wrinkle or twist, making it hard to slide the clips. It could also cause the cord for the contrary electrode to come off. (see page 13, 18)*
- *It may be hard to slide the clips if the cord is wet with ethanol or some other liquid. (see page 13, 18)*
- *After attaching contra angle into the motor handpiece, give the contra angle a light tug to confirm it is securely attached. (see page 14)*
- *After attaching the motor handpiece into handpiece cord, give the motor handpiece a light tug to confirm it is securely attached. (see page 14)*
- *Use caution when inserting and removing files to avoid injury to fingers. (see page 15, 43)*
- *Inserting and removing files without holding the file release button may damage the chuck. (see page 15)*
- *If there is no electrical conductivity between the file and its shank, replace the cap with the one that has an external file electrode. (see page 15)*
- *Do not clip the file electrode to the cutting part of the file. (see page 15)*
- *The file electrode cannot be attached onto some files. (see page 15)*
- *Do not use files with shanks larger than the ISO standard. ISO Standard: Diameter 2.334 to 2.350 mm (see page 15, 37)*
- *Always hold the connector to connect or disconnect cords. (see page 15, 16, 19)*
- *Do not exert any load on the file while the motor is running (about 15 seconds). (see page 16)*
- *To perform calibration, attach an ordinary file. (see page 16)*
- *The light will not work if it is not properly plugged in all the way. (see page 18)*
- *The handpiece end of the cord is a little bigger, and the clip will not slide so easily. Do not force it; stop when it gets hard to slide the clip. (see page 18)*
- *Give the light cure handpiece a light tug to make sure it is securely connected to its cord. (see page 19)*
- *Stop using the instrument and have it repaired if the display does not appear properly or if the instrument suddenly turns off (except in the case where it automatically turns itself off after 10 minutes of not being used). (see page 20, 38)*
- *It is best to disconnect the handpiece when measuring the root canal. (see page 22)*
- *Remove the file from the motor handpiece when taking a measurement. (see page 22)*
- *When the auto torque reverse seems to be triggered too frequently, or it is triggered immediately after starting the normal rotation, increase the torque setting by one line. (see page 23, 25, 27)*
- *Make sure to remove a file from the motor handpiece after completing the Preparing. (see page 23)*
- *Charge the battery as soon as the indicator gets down to the last two bars. (see page 24, 26, 39)*
- *Never use the unit when the battery power display is flashing. The motor will not operate when this display is flashing. (see page 24, 26, 39)*
- *Press the switches firmly. If a switch is not held down long enough, it may not work even though a beep sounds. (see page 24, 26, 39)*
- *Each memory will have its own unique settings. (see page 24, 26, 39)*
- *If the torque setting is too high, the file could jam inside the canal. (see page 25)*
- *The torque settings must be changed depending on the root canal condition. (see page 25, 27)*
- *If all the torque lines are lit up, the motor will not reverse itself no matter how much torque is applied. In this case, make sure that the file is not engaged itself in the canal or it may break. (see page 26)*

CAUTION

- *If the torque limit is too high, the file could get jammed in the canal. In this case, set the micromotor for reverse rotation to free the file. (see page 27)*
- *When the torque reverse function is turned off, the file could be engaged in the root canal and lock up. When this happens, set the micromotor for reverse rotation to free the file. (see page 27)*
- *If the setting for the Torque Slow Down is too low, the motor may stop (lock) without going into reverse. (see page 27)*
- *Occasionally the root canal length indicator bar will make a sudden and large movement as soon as the file is inserted into the root canal, but it will return to normal as the file is advanced down towards the apex. (see page 30)*
- *The contrary electrode could cause an adverse reaction if the patient has an allergy to metals. Ask the patient about this before using the contrary electrode. (see page 31)*
- *Take care that medicinal solutions such as formalin cresol (FC) or sodium hypochlorite do not get on the contrary electrode or the file holder. These could cause an adverse reaction such as inflammation. (see page 31)*
- *If the auto start function does not work because the root canal is too dry (infected canal etc.), moisten the canal with a liquid such as hydrogen peroxide, sodium hypochlorite or saline.* Do not let the liquid overflow the canal opening. (see page 32)*
- *Applying excessive force could cause the file to cut into the root canal wall and lock up. (see page 32)*
- *The motor may overheat if an excessive load is applied. (see page 32)*
- *If the motor gets hot, do not disconnect the motor from its handpiece cord. If a hot motor has been disconnected from its handpiece cord, wait for at least 10 minutes before reconnecting it. (see page 32)*
- *Even if the motor has cooled down enough to operate, it could still be rather hot and excessive loads should not be applied to it. (see page 32)*
- *Root canal preparation cannot be performed entirely with this unit; use this unit in conjunction with standard manual techniques for root canal preparation. Stop using the unit immediately if tactile sensation indicates an unusual or abnormal condition inside the root canal. (see page 33)*
- *Files break more easily at high speeds; always check the rotation speed setting before using the unit. (see page 33)*
- *Use only Ni-Ti or properly designed stainless steel files. (see page 33, 37)*
- *Always remove the file after use. (see page 33)*
- *Nickel-Titanium files are more easily broken by the amount of torque applied to them than stainless steel files. Keep the following points in mind to minimize the possibility of file breakage. (see page 34)*
 - *Before using motor handpiece, use a small hand file, such as #10 or #15, to penetrate the root canal manually down to apex and then return to the apical constriction.*
 - *Never use excessive force to insert the file.*
 - *All foreign matter, such as bits of cotton, should be removed from the root canal before using the file.*
 - *Never use excessive force to advance the file down the root canal.*
 - *Do not use the files on the root canals that have a high degree of curvature.*
 - *Try not to trigger the auto torque reverse function when advancing the file down the root canal.*
 - *The recommended technique for preparing and cleaning the root canal is crown down technique. When using this technique, follow the file manufacturer's guideline.*
 - *If you encounter resistance or the auto torque reverse is triggered, back the file up 3 or 4 mm and carefully advance it down the root canal again. Or replace the file with a smaller size. Never use excessive force.*
 - *Do not force the file down the root canal or press it against the root canal wall as it could break the file.*
- *Do not use the same file continuously for more than 10 seconds in one position as it may create "steps" on the root canal wall.*

CAUTION

- *Be careful using the foot switch because the motor will run when you step on it even if the unit is not measuring the root canal. This could injure the patient's oral mucosa. (see page 34)*
- *Also be careful using the foot switch if the measurement display does not appear, such as when measuring an extremely dry canal, because the motor will run even if a measurement is not being made. (see page 34)*
- *Be careful if the measurement display does not appear, such as when measuring an extremely dry canal, because the motor could start up even if a measurement is not being made. (see page 35)*
- *Use the reverse rotation mode carefully. Since it is designed to release the locked file, its rotation is quite fast and powerful, and may easily break the file. (see page 35)*
- *Always use the guide bar and make sure it will not come out. If the guide bar is not properly fix in place, the internal contact could be bent, and then the instrument might not be able to make accurate measurements or else it might malfunction. (see page 36, 48)*
- *Do not run the motor with the guide bar inserted; this could damage the instrument. (see page 36, 48, 50)*
- *Never put file in or take them out without pressing the button down. This could damage the chuck. Always hold the button down to put a file in or take it out. (see page 37)*
- *Be careful not to cut your finger when putting files in and taking them out. (see page 37)*
- *Do not let the cutting part of the file touch the electrode; this will wear it out very quickly. (see page 37)*
- *Some files cannot be used with this electrode. (see page 37)*
- *Also the Ni-Ti files noted below cannot be used. (see page 37)*
 - *Those with a file diameter of more than 1.2 mm.*
 - *Those with chuck shanks that are nor perfectly round*
 - *Gates-Glidden Drills*
 - *Those that have cutting sections with large diameters such as largo burrs*
- *After use, do not fail to take the file out. (see page 37)*
- *The head does not come off; do not pull on it. (see page 41)*
- *Do not try to rotate the head beyond its limit. (see page 41)*
- *Long continuous use can cause the head to heat up. Do not touch the oral mucosa with it. (see page 42)*
- *In some cases, after the light turns off because of low battery power, the battery will go back up to two bars right away and the light will work again. However, the light will quickly turn off again. The battery should be charged right away. (see page 42)*
- *When disconnecting and connecting the handpiece cord, contrary electrode and foot switch, never pull or push on the cords themselves; always grip the connectors. (see page 43)*
- *Do not wrap the handpiece cord around the body of the main unit. (see page 43)*
- *Inserting and removing files without holding down the file release button will damage the internal contra angle mechanism. (see page 43)*
- *Do not use the unit if the battery indicator is blinking. The motor and light cure handpieces will not work if this indicator is blinking. (see page 43)*
- *If "Lo.b" appears in the speed (timer) display, the battery is extremely low. Stop using the instrument and charge the battery. (see page 43)*
- *If the plug for the AC adapter does not fit the socket, it is the user's responsibility to find a suitable plug adapter. (see page 43)*
- *Use only the AC adapter made for DENTAPORT ZX. (see page 43)*
- *If [F.02] appears in the display, noise has been detected. Turn the unit off and then back on again. If [F.02] still appears, stop using the unit and contact your local dealer or the J.MORITA OFFICE. (see page 44)*
- *Do not pull or yank the cord when disconnecting the AC adapter. (see page 44)*
- *Do not sterilize in any way other than autoclave. (see page 45)*
- *Tho roughly clean and wash the components before autoclaving. If chemical solutions or foreign debris are not removed, autoclaving could damage or deform the components. (see page 45)*
- *Autoclave and dryer temperatures must not exceed +135°C (+275°F). (see page 50)*
- *The Components are extremely hot right after autoclaving; wait for them to cool off before touching them. (see page 49)*

CAUTION

- *Do not autoclave the motor handpiece and handpiece cord. (see page 50)*
- *Remove file to autoclave contra angle. (see page 50)*
- *Follow file manufacturer's recommendations for autoclaving files. (see page 50)*
- *It is highly recommended that instruments be autoclaved in a sterilization pouch (wrapped) or similar device. (see page 50)*
- *Never clean the contra angle or the motor handpiece with chemicals such as formalin cresol (FC) and sodium hypochlorite; these will damage the plastic parts of the components. Immediately wipe away any chemicals that are accidentally spilled on these components. (see page 50)*
- *Do not use any type of oil other than LS Oil. This could damage the instrument. (see page 50)*
- *Never use any type of alcohol other than Ethanol for Disinfection (Ethanol 70 vol% to 80 vol%). (see page 46)*
- *Never wipe the motor and light handpieces or their cords with any type of alcohol other than Ethanol for Disinfection (Ethanol 70 vol% to 80 vol%). Do not use excessive amounts of ethanol or soak the components in it. (see page 46)*
- *Keep the glass on the light cure handpiece clean; otherwise it will lose power. (see page 50)*
- *Do not use excessive amounts of detergent or water and do not soak the components. (see page 46)*
- *Never use any type of alcohol except Ethanol for Disinfection (Ethanol 70 vol% to 80 vol%). Do not use paint thinner, benzine or similar solutions to clean the Canal Preparation and Light Cure Module, AC adapter and foot switch. (see page 46)*
- *Avoid spilling chemical solutions used for treatment on the Canal Preparation and Light Cure Module. These chemicals could damage, deform or discolor the module. Use extra caution to avoid spilling formalin cresol (FC) and sodium hypochlorite as they are quite strong. Wipe up any chemical spills immediately. (Some chemicals may leave traces even if wiped up immediately). (see page 46)*
- *When lubricating the contra angle with oil, use only LS Oil. (see page 47)*
- *Leave the contra angle in a paper cup for at least 10 minutes so that the oil is thoroughly absorbed by the contra angle mechanism. (see page 47)*
- *Stand the contra angle up in the cup with the opening for the file facing down. (see page 47)*
- *The micromotor could be damaged if the contra angle is attached without allowing the excess oil to drain out first. (see page 47)*
- *Do not use any type of spray other than LS Spray or MORITA MULTI SPRAY. This could damage the instrument. (see page 48)*
- *Always shake the LS Spray or MORITA MULTI SPRAY can two or three times before using it. (see page 48)*
- *Use the can in an upright position. (see page 48)*
- *The motor handpiece could be damaged if the contra angle is attached without allowing the excess spray to drain out first. (see page 48)*
- *Do not bend or deform the electrode. (see page 53)*
- *If the bars flicker during use, or if all the bars in the meter do not light up when the file touches the contrary electrode, and cleaning the rotor axle and built-in electrode does not solve this problem, then the built-in electrode is worn out and must be replaced with a new one according to the following procedure. (see page 55)*
- *Always use the guide bur and make sure it will not come out. If the guide bar is not properly fix in place the internal contact could be bent, and then the instrument might not be able to make accurate measurements or else it might malfunction. (see page 55)*
- *Use only the battery that is specially designed for the DENTAPORT ZX Canal Preparation and Light Cure Module. (see page 56)*
- *Do not disconnect the battery while the power is ON. (see page 56)*
- *Be careful not to pinch the battery cord when replacing the cover. (see page 56)*
- *Always use the specified battery. Other batteries might overheat. (see page 56)*
- *Do not use a battery if it is leaky, deformed, discolored or if its label is peeled off. It might overheat. (see page 56)*

Dispose of old battery in an environmentally safe way and in strict accordance with local regulations. (see page 56)

2. Parts Identification



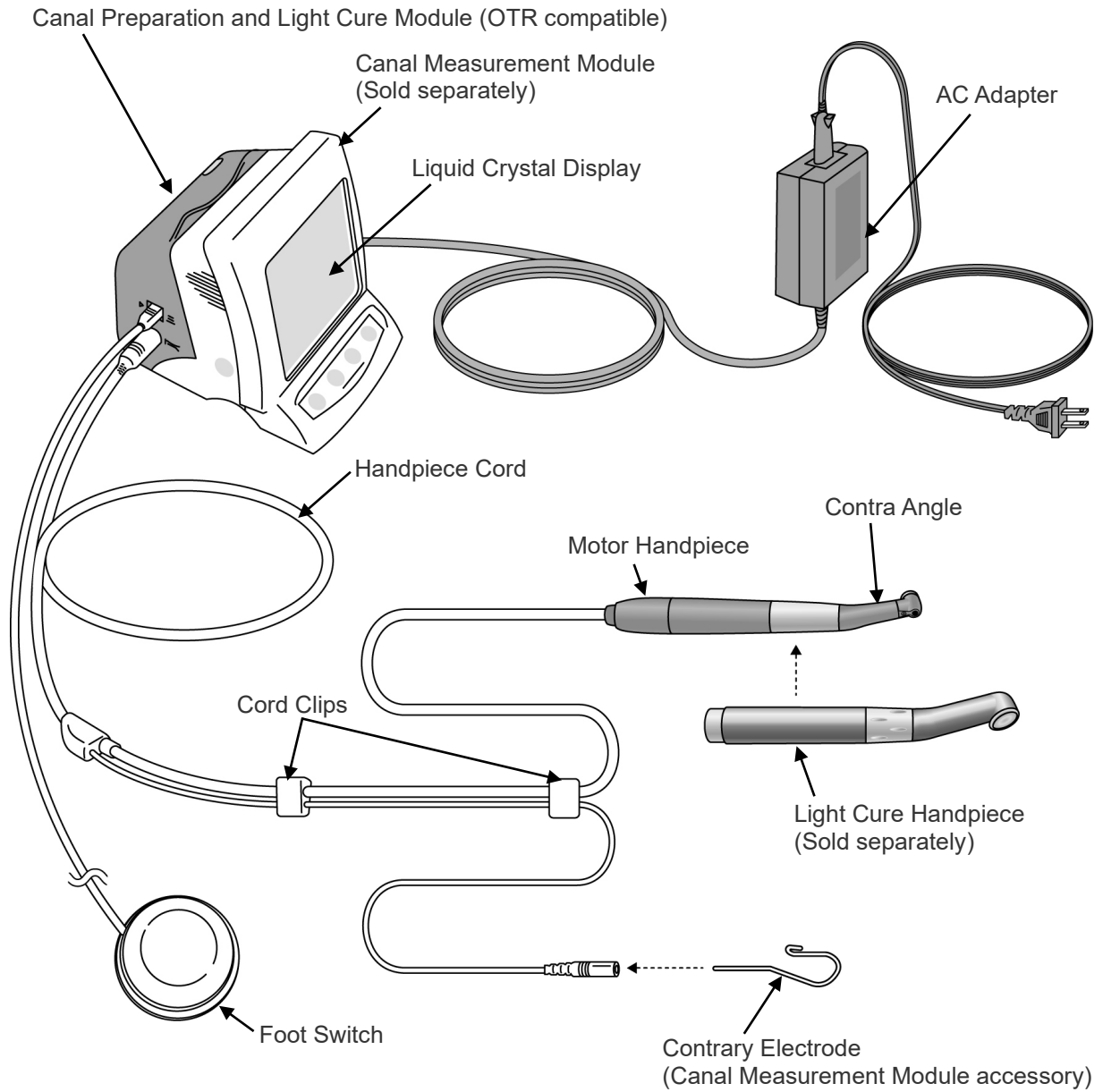







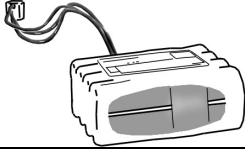
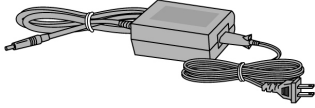
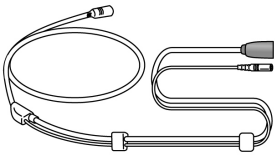

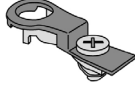

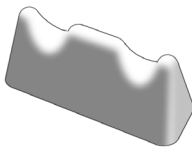
The Canal Preparation and Light Cure Module is used as a low voltage motor and as a base unit for other electronic dental devices.

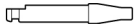

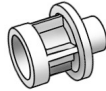
* Connect Canal Preparation and Light Cure Module to Canal Measurement Module.

* Canal Preparation and Light Cure Module cannot be used as an independent unit.

Components

Canal Preparation and Light Cure Module	Battery	AC Adapter	
	(Pre-installed in Canal Preparation and Light Cure Module)  Code No. 7503990	 Code No. 7504005 (230V) Code No. 7504060 (120V)	
Handpiece Cord	Contra Angle	Built-in Electrode	
	 Code No. 8491895	(Pre-installed in Contra Angle)  Code No. 8491887	
Code No. 7503960	Code No. 8491895	Code No. 8491887	
Motor Handpiece	Handpiece Rest	Foot Switch	
			
Code No. 7504003	Code No. 7503965	Code No. 7503985	
Guide Bar	LS Oil	LS Spray or MORITA MULTI SPRAY (Sold Separately)	Spray Nozzle (Sold Separately)
		* Use only the LS SPRAY or MORITA MULTI SPRAY to clean and lubricate the contra angle. 	* Keep this nozzle and use it again when replacing the spray can. For maintenance of contra angle, either spray (LS SPRAY or MORITA MULTI SPRAY) with the spray nozzle or LS OIL may be used. 
Code No. 8491763	Code No. 8491720	Code No. 5071340(LS SPLAY) 5010201 (MORITA MULTI SPRAY)	Code No. 7503970
Cap with External File Electrode (Sold Separately)	Light Cure Handpiece (Sold Separately)	Disposable Covers for Light Cure Handpiece (Sold Separately)	Eye Protector (Sold Separately)
	  (100 Disposable Covers included)	 (1 Box of 100)	
Code No. 8491879	Code No. 5344220	Code No. 6810310	Code No. 7506532

3. Assembling the Unit

* Canal Preparation and Light Cure Module will not operate unless connected to the Canal Measurement Module.

Attaching Canal Preparation and Light Cure Module to Canal Measurement Module

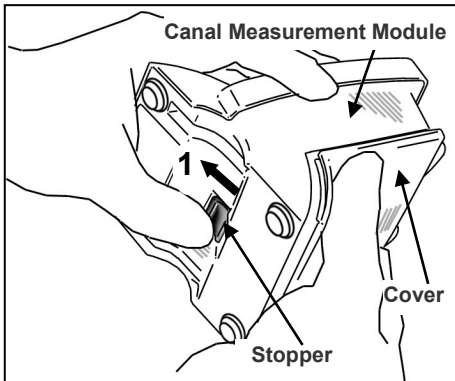

1. Hold the cover and slide the stopper on the bottom towards the liquid crystal display.

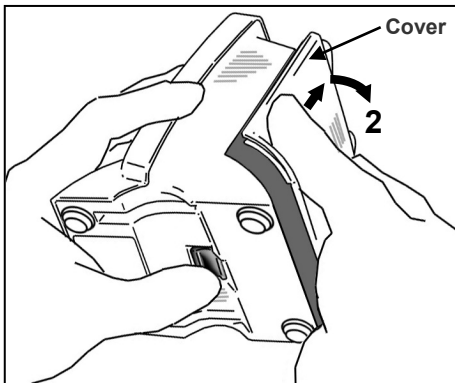

2. Slide the cover in the direction indicated by the arrow in the illustration and remove it from the Canal Measurement Module.

*The cover and batteries will not be used.

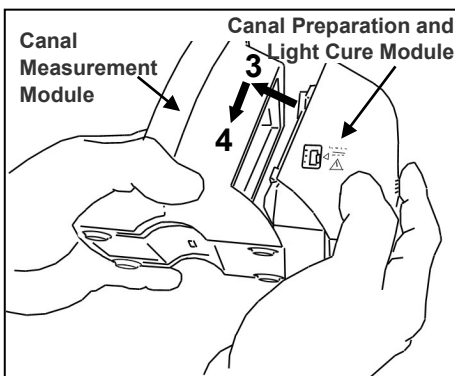

3. Line up the tabs on the Canal Preparation and Light Cure Module with the notches in the Canal Measurement Module and put the two modules together.

4. Slide the Canal Preparation and Light Cure Module all the way down until it is securely attached.

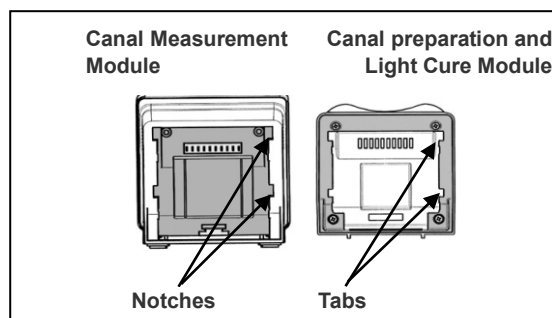

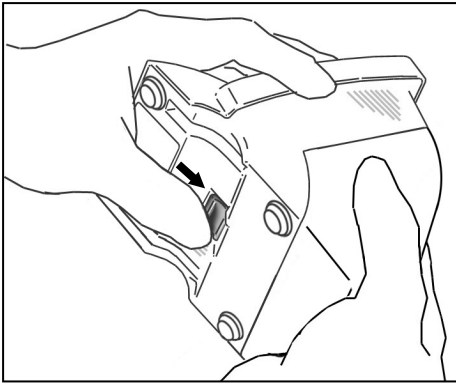

⚠ CAUTION

- *If the catch on the bottom is not back in its original place after attachment, push it in the direction shown by the arrow in the illustration.*
- *After installation, give the Canal Preparation and Light Cure Module a light tug to confirm it is securely attached.*

Charging Battery

The battery is built into the Canal Preparation and Light Cure Module. Refer to “Charging Battery” on page 43.

⚠ CAUTION

- *The battery is not charged when the unit is shipped from the factory and must be charged before using the unit.*

4. Before Using the Unit

Canal Preparation (see page 18 for Light Cure)

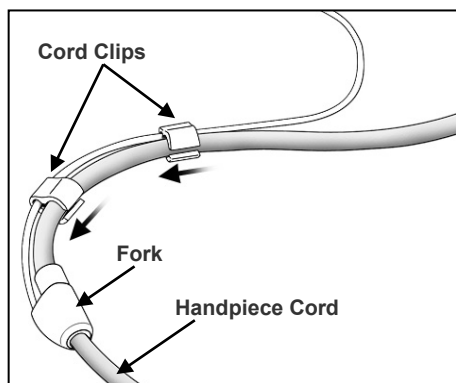
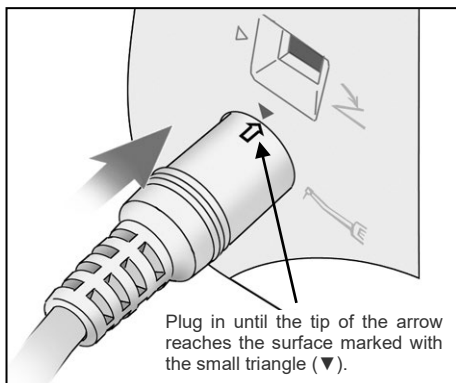
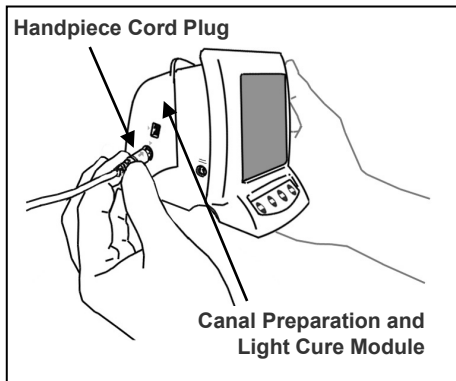

Attaching Handpiece Cord

1. Line up the arrow on the handpiece cord's plug with the small triangle above its jack and plug it all the way in until the arrow disappears inside the jack.

⚠ CAUTION

- *Handle the Canal Preparation and Light Cure Module carefully; do not drop, bump or expose the unit to other kinds of impacts or shocks. Rough handling could cause damage.*
- *Make sure the plug is all the way in; otherwise there could be measurement, operation or display problems.*
- *Do not drop anything on or bang the plug after it has been inserted into the jack.*

2. Slide the cord clips one at a time down to where the cords fork so that they do not interfere with the use of the cord for the contrary electrode.

⚠ CAUTION

- *Sliding the cord clips with too much force could cause the tube to wrinkle or twist, making it hard to slide the clips. It could also cause the cord for the contrary electrode to come off.*
- *It may be hard to slide the clips if the cord is wet with ethanol or some other liquid.*

Assembling Motor Handpiece

*Contra angle must be lubricated with LS Oil before using for the first time.

Refer to page 47.

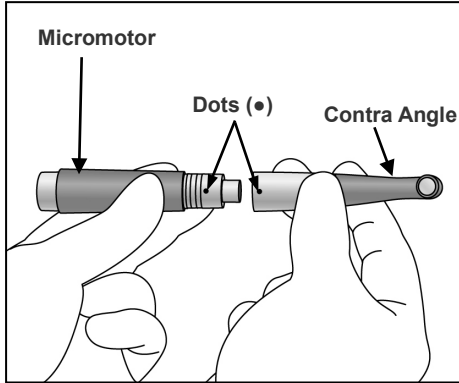

1. Line up the dots on the motor handpiece and contra angle and slide the contra angle straight onto the motor handpiece until it clicks securely into place. The contra angle has a simple snap-on connection.

⚠ CAUTION

- *After attaching contra angle into the motor handpiece, give the contra angle a light tug to confirm it is securely attached.*

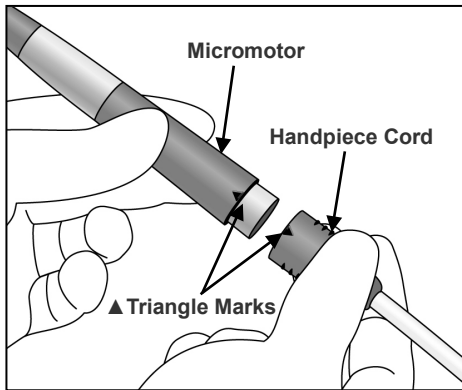

2. Line up the triangle marks to connect the motor handpiece to handpiece cord.

⚠ CAUTION

- *After attaching the motor handpiece into handpiece cord, give the motor handpiece a light tug to confirm it is securely attached.*

Assembling File and File Electrode

*Use only nickel-titanium files for root canal preparation.

⚠ WARNING

- *Never use stretched, deformed or damaged files.*

Hold down the file release button on the contra angle and insert the file. Turn the file back and forth until it is lined up with interior latch groove and slips into place. Release the button to lock the file into the contra angle.

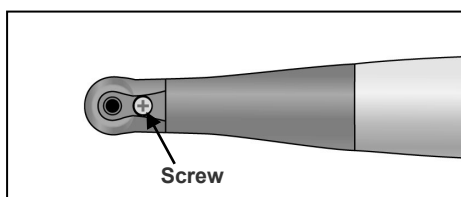
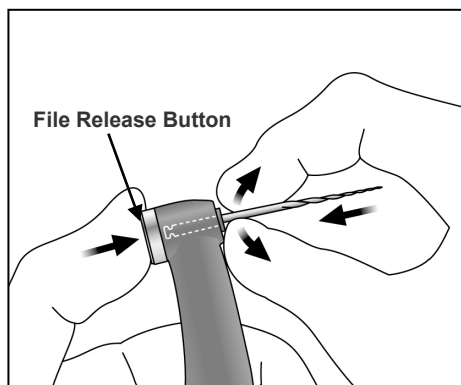

⚠ WARNING

- *Give the file a light tug to confirm it is securely held in place. If the file is not securely placed, it could come out and injure the patient.*
- *Make sure the screw is properly tightened up. It could come out and be swallowed if it is loose; also canal measurements may not be accurate.*

⚠ CAUTION

- *Use caution when inserting and removing files to avoid injury to fingers.*
- *Inserting and removing files without holding the file release button may damage the chuck.*
- *If there is no electrical conductivity between the file and its shank, replace the cap with the one that has an external file electrode. (see page 36).*
- *Do not clip the file electrode to the cutting part of the file.*
- *The file electrode cannot be attached onto some files.*
- *Do not use files with shanks larger than the ISO standard. ISO Standard: Diameter 2.334 to 2.350 mm*

Attaching Contrary Electrode

Insert the contrary electrode (lip clip) into the connector of the handpiece cord. (The contrary electrode is an accessory provided with the Canal Measurement Module.)

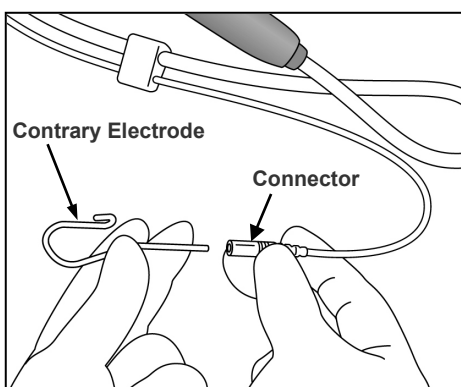

⚠ CAUTION

- *Always hold the connector to connect or disconnect cords.*

Attaching Foot Switch

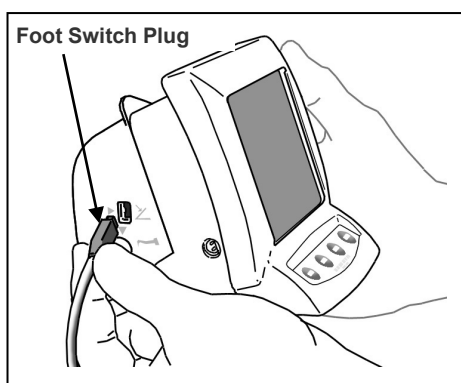

Insert the foot switch plug all the way into its jack on the side of the Canal Preparation and Light Cure Module.
[This jack is marked with a small triangle (▶) pointing right.]

⚠ CAUTION

- *Always hold the connector to connect or disconnect cords.*
- * Operate the handpiece with the foot switch if a canal cannot be accurately measured.

Calibration

- * Before using right after purchase, whenever the motor handpiece or contra angle has been replaced, or if the motor alternates between reverse and forward rotation outside the canal, calibrate the instrument in the following way.

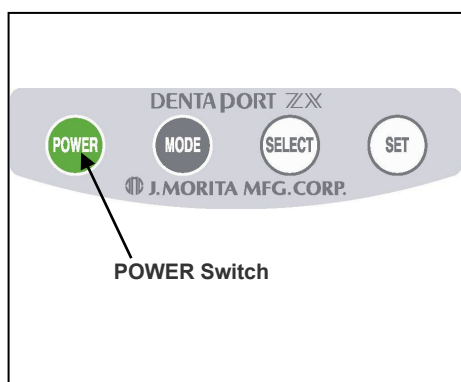

1. Press the POWER switch and turn the unit on.

2. When the M1 display comes up, hold the SELECT switch. While still holding the SELECT switch, press and hold the MODE switch until “CAL” is displayed in the lower left part of the display.

3. Hold the motor with the file pointing down and press the SET switch.
The motor will start running and adjust itself.

⚠ CAUTION

- *Do not exert any load on the file while the motor is running (about 15 seconds).*
- *To perform calibration, attach an ordinary file.*

4. When the motor stops, press the POWER switch to turn the unit off.



Checking the Function

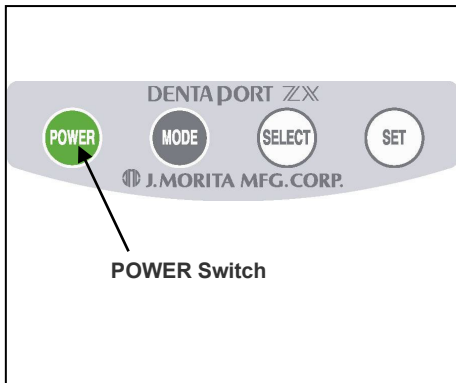

1. Press the POWER switch to turn the unit on. Display used for root canal preparation will appear.
 - *The unit will automatically turn off after 10 minutes of non-use.
 - *Wait at least 3 seconds after the power goes off before turning it back on again.
 - *Do not turn the power on while stepping on the foot switch.
 - *If there is a sequence of single and double beeps right after you turn the unit on, the built-in electrode needs to be replaced. When connecting the motor handpiece to the handpiece cord and using the module in conjunction with the root canal measurement function, clean the rotor axle and replace the electrode before making any measurements. (see page 55) After replacing the built-in electrode, press the SET switch while the alarm is beeping. Then the beeper alarm will be OFF until next estimated replacement timing.
2. Check that the handpiece cord is properly plugged into the jack.
3. Check that the contra angle is securely attached to the motor handpiece.
4. Check that the file is properly installed. Give it a light tug to confirm.
5. Check that the contrary electrode is attached to the connector of the handpiece cord.
6. Contact the file with contrary electrode and check that all the root canal length indicator bars on the display are lit, the word "APEX" flashes and audible beep becomes continuous. Use caution when contacting the file with contrary electrode as the file starts to rotate as soon as the file touches the contrary electrode.

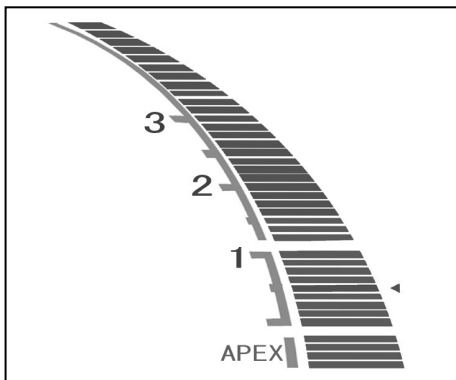
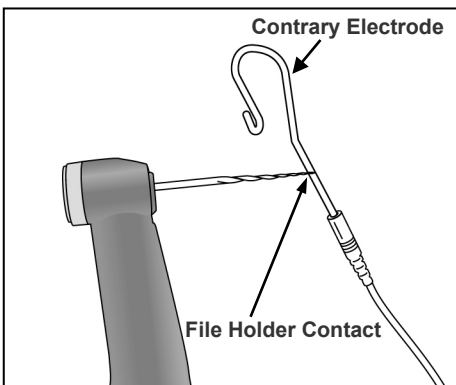

⚠ WARNING

- ***Check the DENTAPORT ZX's operation before each patient. If the indicators in the display do not all appear normally, the instrument may not be able to make an accurate measurement. In this case, stop using the instrument and have it repaired.***

Light Cure

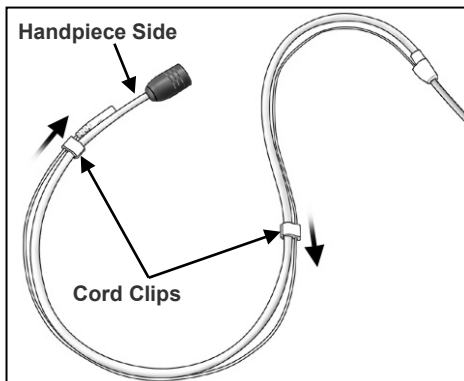
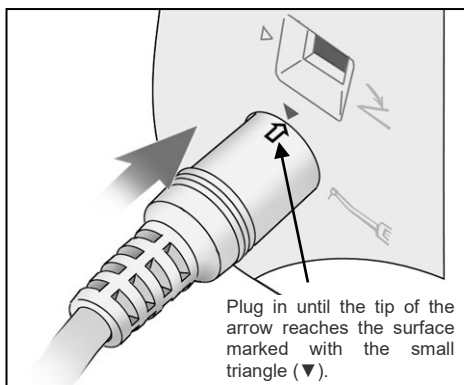
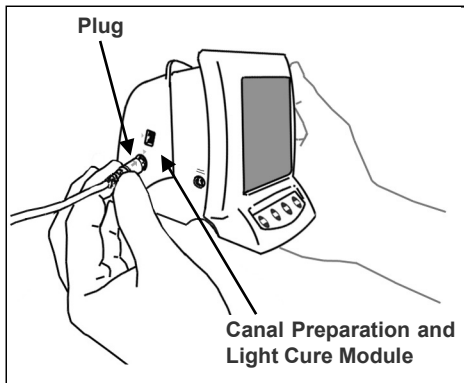

Attaching Handpiece Cord

1. Line up the arrow on the handpiece cord's plug with the small triangle above its jack and plug it all the way in until the arrow disappears inside the jack.

⚠ CAUTION

- *Handle the Canal Preparation and Light Cure Module carefully; do not drop, bump or expose the unit to other kinds of impacts or shocks. Rough handling could cause damage.*
- *The light will not work if it is not properly plugged in all the way.*
- *Do not drop anything on or bang the plug after it has been inserted into the jack.*

2. Slide the cord clips one at a time away from the fork in the cords so that they hold the cord for the contrary electrode, and it does not get in the way.

⚠ CAUTION

- *Sliding the cord clips with too much force could cause the tube to wrinkle or twist, making it hard to slide the clips. It could also cause the cord for the contrary electrode to come off.*
- *The handpiece end of the cord is a little bigger, and the clip will not slide so easily. Do not force it; stop when it gets hard to slide the clip.*
- *It may be hard to slide the clips if the cord is wet with ethanol or some other liquid.*

Connect the Light Cure Handpiece

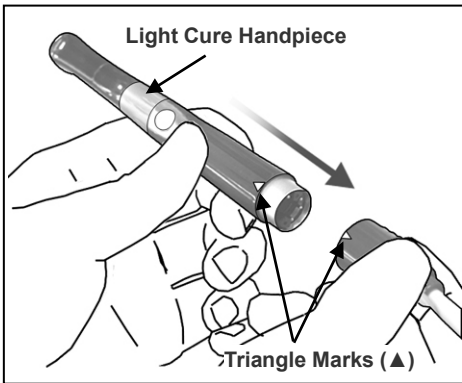

1. Line up the triangle marks on the handpiece cord and the light cure handpiece and put the handpiece all the way onto its cord.

⚠ CAUTION

- Give the light cure handpiece a light tug to make sure it is securely connected to its cord.

Attaching Foot Switch

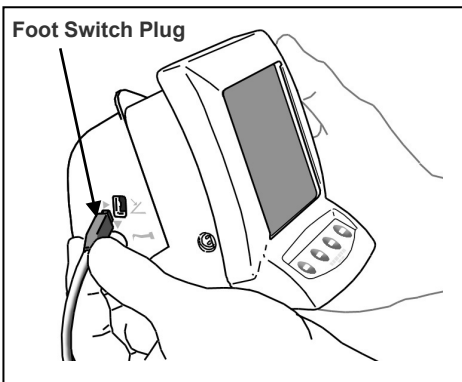

- Insert the foot switch plug all the way into its jack on the side of the Canal Preparation and Light Cure Module.
[This jack is marked with a small triangle (▶) pointing right.]

⚠ CAUTION

- Always hold the connector to connect or disconnect cords.

Checking the Function

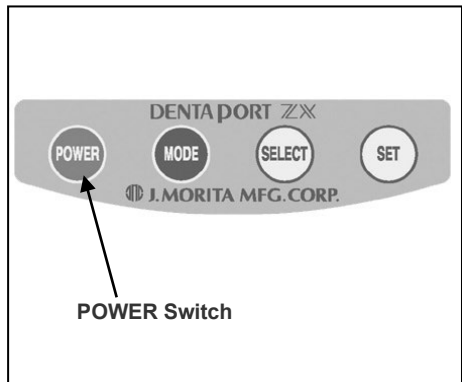

1. Press the POWER switch to turn the unit on.
 - *The unit will automatically turn off after 10 minutes of non-use.
 - *Wait at least 3 seconds after the power goes off before turning it back on again.
 - *Do not turn the power on while stepping on the foot switch.
2. Make sure the handpiece cord is securely plugged in.
3. Make sure the handpiece is securely connected.
4. Press the Light Switch to turn the light on.
 - *Press the Light switch again to turn the light off.
 - *Do not fail to use a disposable cover for treatment.

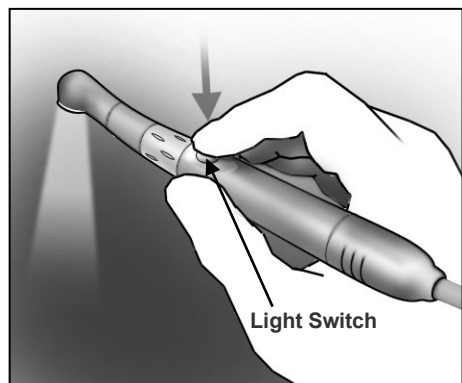

⚠ WARNING

- Do not let the light strike any one in the eye. Also do not look directly at the light or continuously at the area being irradiated; this could damage your eyesight.

5. Operating the Unit

Canal Preparation (see page 38 for Light Cure)

WARNING

- *If there is a lightning storm while the battery is being charged, do not touch the main unit, the AC adapter or the main power cord; you could get a shock.*

CAUTION

- *Stop using the instrument and have it repaired if the display does not appear properly or if the instrument suddenly turns off (except in the case where it automatically turns itself off after 10 minutes of not being used).*

Overview of Features and Functions

The combination of the Canal Preparation and Light Cure Module with the Canal Measurement Module allows the motor handpiece to be controlled in a variety of ways. The root canal can be enlarged and prepared with great precision and delicacy.

Easy Operation

Press the **POWER** switch to turn the unit on and press the **MODE** switch to select any one of three memories. Each memory can be set for different motor control parameters. The desired set of parameters can be easily selected by pressing MODE switch button.

<OTR Mode>

If the file torque is less than the set value, the file will keep rotating in the forward direction. When the file torque is more than the set value, the file will automatically start rotating 90° in reverse and 180° forward repeatedly. Furthermore, the OTR mode can set various motor controls as described below.

- **File Rotation Speed**
There are 3 speed settings: 100, 300, and 500 rpm.
 - **Auto Start and Stop**
The file automatically starts rotating when inserted inside the canal (when meter reading is at least 2 lines) and stops when it is withdrawn.
 - **Auto Apical Reverse and Auto Apical Stop** (You may also turn off this function.)
The motor will stop (Auto Apical Stop) or reverse (Auto Apical Reverse) itself when the file tip reaches the point specified by the meter reading (bar) selected to indicate the working length.
You may select either Stop or Reverse.
 - **Optimum Torque Reverse (OTR compatible)**
If the file torque is more than the set value, it will automatically start rotating 90° in reverse and 180° forward repeatedly.
 - **Torque Setting**
The torque for the OTR function can be set at 4 different levels.
- * **These torque values vary somewhat depending on the condition of the micromotor and the gears.**

Torque Line	Torque (g·cm) Approx.	Torque (N·cm) Approx.
1	20	0.2
2	40	0.4
3	60	0.6
4	100	1.0

- **Adjustable sound volume**
Volume of audible signal can be adjusted.
- The unit will automatically go into the root canal measurement mode if it detects any abnormality such as the one caused by electrical noise. However, it will return to the normal mode when the file is taken out of the root canal.
- The motor handpiece can also be operated with the foot switch.

<Normal Mode>

If the file torque is less than the set value, the file will keep rotating in the forward direction. When the file torque is more than the set value, the file will automatically start rotating in reverse direction. Furthermore, the Normal mode can set various motor controls as described below.

- File Rotation Speed
8 speeds setting from 150 rpm to 800 rpm can be selected.
- Auto Start and Stop
The file automatically starts rotating when inserted inside the canal (when meter reading is at least 2 lines) and stops when it is withdrawn.
- Auto Apical Reverse and Auto Apical Stop (You may also turn off this function.)
The motor will stop (Auto Apical Stop) or reverse (Auto Apical Reverse) itself when the file tip reaches the point specified by the meter reading (bar) selected to indicate the working length.
You may select either Stop or Reverse.
- Setting Stopping Time before the File Reverses
When Auto Apical Reverse function is triggered, the interval between the file stopping the rotation and reversing can be set.
- Auto Torque Reverse
The file automatically reverses its rotation when the torque load reaches a specified preset value.
- Torque Setting for Auto Torque Reverse
There are 11 settings available for the value of the torque that will trigger the Auto Torque Reverse function. The Auto Torque Reverse function can also be turned off. Please refer to the table below.
- * ***These torque values vary somewhat depending on the condition of the micromotor and the gears.***

Torque Line	Torque (g·cm) Approx.	Torque (N·cm) Approx.
1	20	0.2
2	40	0.4
3	60	0.6
4	100	1.0
5	150	1.5
6	180	1.8
7	250	2.5
8	300	3.0
9	350	3.4
10	400	3.9
11	500	4.9
ALL	OFF	OFF

* Setting the torque level for line 10 or 11 could result in the file preparing into the canal wall and locking up.

- Auto Apical Slow Down
The file automatically slows down as it approaches the apex so that the region near the apical foramen can be treated with a slow gentle rotation. This function can also be turned off.
The rate at which the file slows down depends on the speed setting.
- Auto Torque Slow Down Function:
The file slows down automatically as the torque on it approaches the set limit. This function can be turned off.
- Adjustable sound volume
Volume of audible signal can be adjusted.
- The unit will automatically go into the root canal measurement mode if it detects any abnormality such as the one caused by electrical noise. However, it will return to the normal mode when the file is taken out of the root canal.
- The motor handpiece can also be operated with the foot switch.

Root Canal Measurement (Two Methods)

Plug the probe cord into the Canal Measurement Module and connect the file holder and contrary electrode.

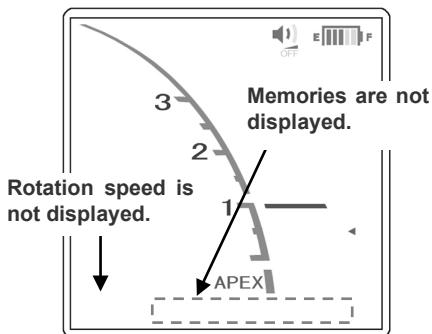
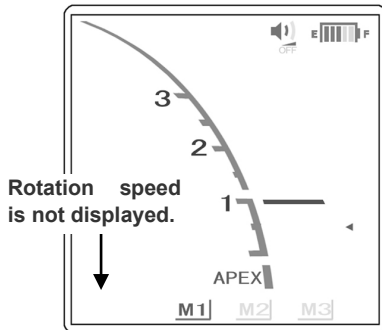
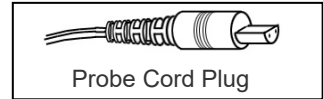

a: Detach the motor handpiece from handpiece cord. Select M1, M2 or M3 with pressing the MODE switch and measure length of a root canal. (Refer to the operation manual for the Canal Measurement Module.)

b: Leaving the motor handpiece connected and press the MODE switch until the speed and memory displays disappear. (Refer to the operation manual for the Canal Measurement Module.)

⚠ WARNING

- *Make sure that the contrary electrode, file holder, handpiece file electrode etc., do not come into contact with an electric power source such as an electrical socket. This could result in a severe electrical shock.*
- *Before measuring length of a root canal, make sure that the rotation speed does not appear on the display. If the rotation speed appears on the display, the unit is set for root canal preparation mode, and the handpiece will start running. This could result in an injury.*

⚠ CAUTION

- *It is best to disconnect the handpiece when measuring the root canal.*
- *Remove the file from the motor handpiece when taking a measurement.*

Preparing the Root Canal

Plug the handpiece cord into the Canal Preparation and Light Cure Module and then connect the handpiece and the contra angle.

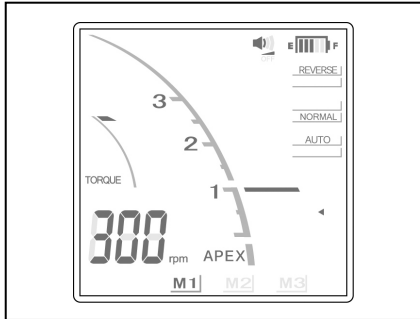
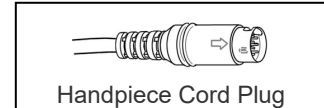

Press the MODE switch to select M1, M2, or M3, and then perform root canal Preparing.

⚠ WARNING

- *Make sure that the contrary electrode, file holder, handpiece file electrode etc., do not come into contact with an electric power source such as an electrical socket. This could result in a severe electrical shock.*

⚠ CAUTION

- *When the auto torque reverse seems to be triggered too frequently, or it is triggered immediately after starting the normal rotation, increase the torque setting by one line.*
- *Make sure to remove a file from the motor handpiece after completing the Preparing.*

Liquid Crystal Display and Switches

<OTR Mode>

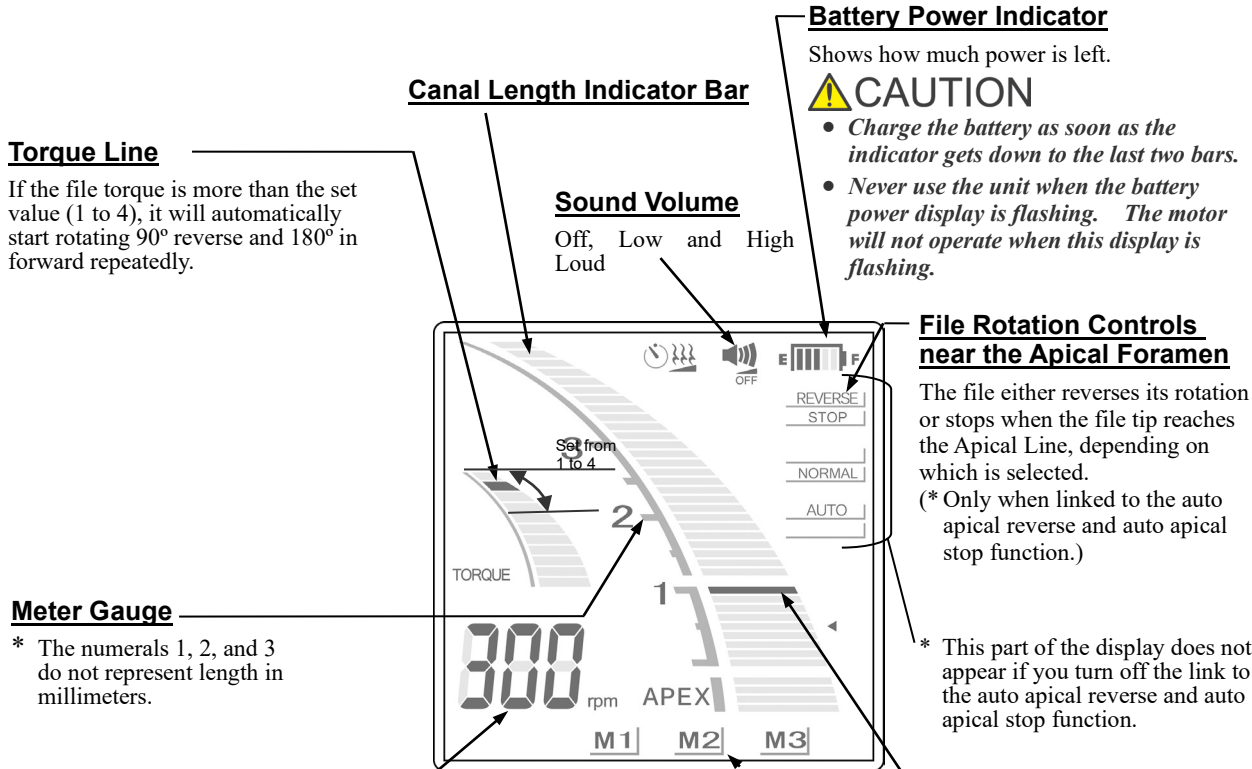

Rotation Speed
Speed can be set for 100, 300, and 500 rpm. Refer to "Setting and Changing Memory" on the page 25.

WARNING
 • Make sure the speed is not being displayed when measuring the length of the root canal.

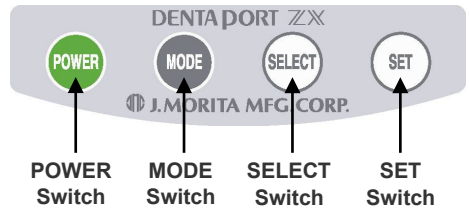

CAUTION
 • Press the switches firmly. If a switch is not held down long enough, it may not work even though a beep sounds.

Apical Line
Use this line as an estimate of the root canal's working length. It can be set anywhere between 2 and Apex. The file automatically stops and reverses its rotation when the file tip reaches this line (auto apical reverse function). A continuous beep will also sound when the file reverses its rotation.

Memory (M1, M2, and M3)

Refer to the section "Setting and Changing Memory" for details.

- These are not displayed when measuring root canal with the micromotor connected. When the micromotor is disconnected, M1, M2, and M3 will represent Canal Measurement Module memories, not the Preparation and Light Cure Module memories. Refer to the operation manual for Canal Measurement Module.
- When changing the torque reverse memory in OTR mode, "-f-" appears in the rotation speed window for about 1 second. (In Normal mode, the rotation speed is displayed as usual.)
- In OTR mode, "-f-" appears in the rotation speed window when the motor is running.

CAUTION
 • Each memory will have its own unique settings.







Torque Settings

⚠ CAUTION

- If the torque setting is too high, the file could jam inside the canal.
- The torque settings must be changed depending on the root canal condition.
- When the auto torque reverse seems to be triggered too frequently, or it is triggered immediately after starting the normal rotation, increase the torque setting by one line.

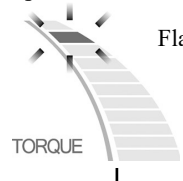
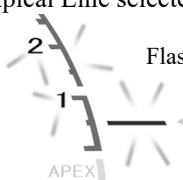
Settings and Changing Memory

Use the MODE switch to select M1, M2 or M3. Use the SELECT switch to select rotation speed, Torque Line or Apical Line. Use the SET switch to set the memory contents.

 Select the memory. Press	 Select the function (The display will briefly flash on and off.) Press	 Select the function * Press when blinking. Press
<p>M1 (memory 1) Root canal preparation Mode 1</p> <p>M2 (memory 2) Root canal preparation Mode 2</p> <p>M3 (memory 3) Root canal preparation Mode 3</p>	<p>Torque Line selected.</p>  <p>Flashes</p> <p>Apical Line selected.</p>  <p>Flashes</p> <p>Rotation Speed.</p>  <p>Flashes</p>	<p>Set Torque Line.</p>  <p>Apical Line The apical line can be set between 2 and APEX.</p>  <p>Speed can be set for 100, 300, and 500 rpm.</p> 
<p>No display Root canal measurement mode*</p>	<p>* For how to make settings for root canal measurement, refer to the separate user's manual for the root canal measurement module.</p>	

* All memory settings will be retained even after the unit is turned off. Simply select M1, M2, or M3 to use those memory settings. If the micromotor is connected, M1 will be selected when the unit is turned on. (If the micromotor is not connected, the memory selected when the unit is turned on will be canal measurement memory last used.)

⚠ WARNING

- Check the settings displayed after selecting memories.

<Normal Mode>

Motor Stopping Time for Apical Reverse

0, 0.25 (), 0.5 () and 1 () second. The file rotation stops for the specified period before it reverses.

Canal Length Indicator Bar

Meter Gauge

* The numerals 1, 2, and 3 do not represent length in millimeters.

Torque Line

11 settings for auto torque reverse. Torque reverse may also be turned off. The motor automatically reverses if the torque exceeds the specified limit. Refer to the **NOTE** concerning the torque setting on the page 27. If all torque lines are lit up, the reverse torque function is turned off.

CAUTION

- If all the torque lines are lit up, the motor will not reverse itself no matter how much torque is applied. In this case, make sure that the file is not engaged itself in the canal or it may break.

Rotation Speed

Speed can be set for 150, 200, 250, 300, 400, 500, 600 and 800 rpm. Refer to "Setting and Changing Memory" on the page 27.

WARNING

- Make sure the speed is not being displayed when measuring the length of the root canal.

Sound Volume

Off, Low and High Loud

Battery Power Indicator

Shows how much power is left.

CAUTION

- Charge the battery as soon as the indicator gets down to the last two bars.
- Never use the unit when the battery power display is flashing. The motor will not operate when this display is flashing.

File Rotation Controls near the Apical Foramen

The file either reverses its rotation or stops when the file tip reaches the Apical Line, depending on which is selected.

(* Only when linked to the auto apical reverse and auto apical stop function)

File Rotation Speed Controls near the Apical Foramen

Slow Down

File rotation slows down as it approaches the apical foramen for safe treatment.

Normal

File rotates at specified speed even near the apical foramen.

* This part of the display does not appear if you turn off the link to the auto apical reverse and auto apical stop function.

Manual Mode

Use the manual mode to operate the unit outside the canal. (See page 35 for details.)

Apical Line

Use this line as an estimate of the root canal's working length. It can be set anywhere between 2 and Apex. The file automatically stops and reverses its rotation when the file tip reaches this line (auto apical reverse function). A continuous beep will also sound when the file reverses its rotation.

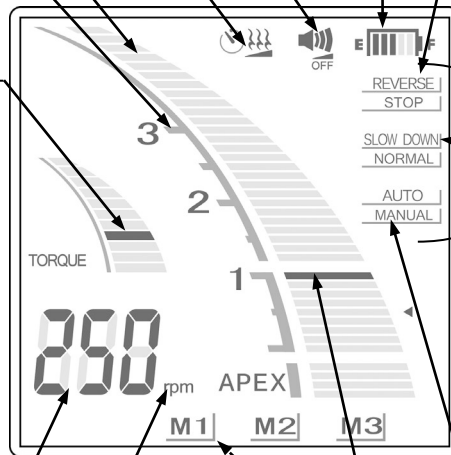

Auto Torque Slow Down

When "rpm" is lit, the file rotates at the set speed regardless of the load (torque). When "rpm" is not lit up, the file slows down as the load on it increases

Memory (M1, M2, and M3)

Refer to the section "Setting and Changing Memory" for details.

* These are not displayed when measuring root canal with the micromotor connected. When the micromotor is disconnected, M1, M2, and M3 will represent Canal Measurement Module memories, not Low Speed Handpiece Module memories. Refer to the operation manual for Canal Measurement Module.

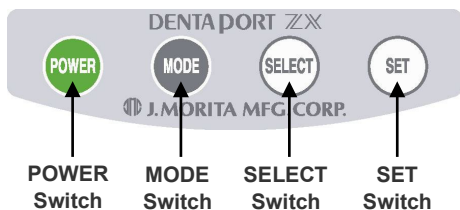

CAUTION

- Press the switches firmly. If a switch is not held down long enough, it may not work even though a beep sounds.

CAUTION

- Each memory will have its own unique settings.







Torque Settings

⚠ CAUTION

- If the torque limit is too high, the file could get jammed in the canal. In this case, set the micromotor for reverse rotation to free the file. (See page 35, “Reverse Rotation.”)
- When the torque reverse function is turned off, the file could be engaged in the root canal and lock up. When this happens, set the micromotor for reverse rotation to free the file.
- The torque settings must be changed depending on the root canal condition.
- When the auto torque reverse seems to be triggered too frequently, or it is triggered immediately after starting the normal rotation, increase the torque setting by one line.
- If the setting for the Torque Slow Down is too low, the motor may stop (lock) without going into reverse.

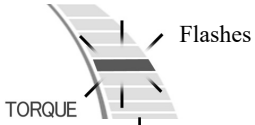
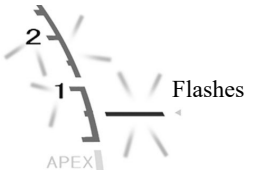
Settings and Changing Memory

Use the MODE switch to select M1, M2 or M3. Use the SELECT switch to select rotation speed, Torque Line or Apical Line. Use the SET switch to set the memory contents.

 MODE Press	 SELECT Press Select the function (The display will briefly flash on and off.)	 SET Press Set the memory content. * Press when blinking.
<div style="display: flex; flex-direction: column; align-items: center;"> <div style="display: flex; align-items: center; margin-bottom: 10px;"> <div style="text-align: center; margin-right: 10px;"> <p>M1 (memory 1)</p> </div> <div style="text-align: center;"> <p>Root canal preparation Mode 1</p> </div> </div> <div style="margin-bottom: 10px;">↓</div> <div style="display: flex; align-items: center; margin-bottom: 10px;"> <div style="text-align: center; margin-right: 10px;"> <p>M2 (memory 2)</p> </div> <div style="text-align: center;"> <p>Root canal preparation Mode 2</p> </div> </div> <div style="margin-bottom: 10px;">↓</div> <div style="display: flex; align-items: center; margin-bottom: 10px;"> <div style="text-align: center; margin-right: 10px;"> <p>M3 (memory 3)</p> </div> <div style="text-align: center;"> <p>Root canal preparation Mode 3</p> </div> </div> <div style="margin-bottom: 10px;">↓</div> <div style="display: flex; align-items: center;"> <div style="text-align: center; margin-right: 10px;"> <p>No display</p> </div> <div style="text-align: center;"> <p>Root canal measurement mode</p> </div> </div> </div>	<p>Torque Line selected.</p>  <p>Apical Line selected.</p>  <p>Rotation Speed.</p> 	<p>Set Torque Line.</p>  <p>Apical Line The apical line can be set between 2 and APEX.</p>  <p>Speed can be set for 150, 200, 250, 300, 400, 500, 600 and 800 rpm.</p> 
	<p>* For how to make settings for root canal measurement, refer to the separate user’s manual for the root canal measurement module.</p>	

* All memory settings will be retained even after the unit is turned off. Simply select M1, M2, or M3 to use those memory settings. If the motor handpiece is connected, M1 will be selected when the unit is turned on. (If the motor handpiece is not connected, the memory selected when the unit is turned on will be the canal measurement memory last used.)

⚠ WARNING













- Check the settings displayed after selecting memories.

Setting Memories for Other Functions

<OTR Mode>

To change the settings other than Torque Line, Apical Line or Rotation Speed, take the following steps.

1. Turn the power off.
2. Press the SELECT switch and turn the power back on without releasing the SELECT switch.
3. Press the MODE switch to select M1, M2, or M3.
4. Press the SELECT switch 3 times to pass the Torque Line, Apical Line and Speed settings.
5. Use the SELECT switch to select the item, and then use the SET switches to enter the settings into the memory.













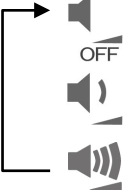







 Select the item. Press (Display will briefly flash on and off.)	 Set the memory content. Press * Press when blinking.
<p>Sound volume selected</p>  Flashes	 Turn sound off.  Set sound volume low  Set sound volume high
<p>Rotation control when file tip reaches Apical Line. * Only if link to the auto apical reverse and auto apical stop function is turned on.</p>  Flashes	 Set for Reverse.
<p>Mode Selection</p>  Flashes OTR Mode	 Normal Mode
<p>Auto Apical Reverse or Auto Apical Stop On or Off</p>  Flashes ON	 OFF

To Torque Line Selection

<Normal Mode>

To change the settings other than Torque Line, Apical Line or Rotation Speed, take the following steps.

1. Turn the power off.
2. Press the SELECT switch and turn the power back on without releasing the SELECT switch.
3. Press the MODE switch to select M1, M2, or M3.
4. Press the SELECT switch 3 times to pass the Torque Line, Apical Line and Speed settings.
5. Use the SELECT switch to select the item, and then use the SET switches to enter the settings into the memory.

 Select the item. Press (Display will briefly flash on and off.)	 Set the memory content. Press * Press when blinking.
Sound volume selected  Flashes	 Turn sound off.  Set sound volume low  Set sound volume high
Rotation control when file tip reaches Apical Line. * Only if link to the auto apical reverse and auto apical stop function is turned on.  Flashes	 Set for Reverse.
Rotation control as file tip approaches apical foramen. * Only if link to the auto apical reverse and auto apical stop function is turned on.  Flashes	 Set for Slow Down.
Apical reverse stop time. * Only if link to canal measurement is turned on.  Flashes	 0 sec.  0.25 sec.  0.5 sec.  1 sec.
Auto Torque Slow Down (Appears in the speed display)  Flashes Turn off Auto Torque Slow Down	 Set for Auto Torque Slow Down * The speed (rpm) is not displayed if the unit is set for auto torque slow down.
Mode Selection  Flashes Normal Mode	 OTR Mode
Auto Apical Reverse or Auto Apical Stop On or Off  Flashes ON	 OFF

To Torque Line Selection

Factory Settings for Memories

Item	Memory		
	M1	M2	M3
Mode	OTR Mode	OTR Mode	Normal Mode
Speed (rpm)	300	500	250
Torque	1	1	3

Meter Display

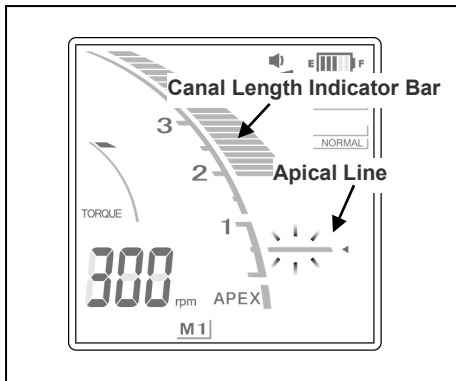

The position of the file tip is shown by the root canal length indicator bar on the display. The apical line flashes on and off once file is inserted into the root canal.

⚠ CAUTION

- Occasionally the root canal length indicator bar will make a sudden and large movement as soon as the file is inserted into the root canal, but it will return to normal as the file is advanced down towards the apex.

⚠ WARNING

- **In some cases such as a blocked root canal, a measurement can not be made.**
(For details refer to the section of the manual for the canal measurement module that covers canal not suitable for measurement.)
- **Accurate measurement is not always possible, especially in cases of abnormal or unusual root canal morphology; make sure to take an X-ray to check the measurement results.**
- **Stop using the unit immediately if it does not seem to be working properly.**
- **If the indicator bar for the canal length does not appear even when the file is inserted, the unit may be malfunctioning and must not be used.**

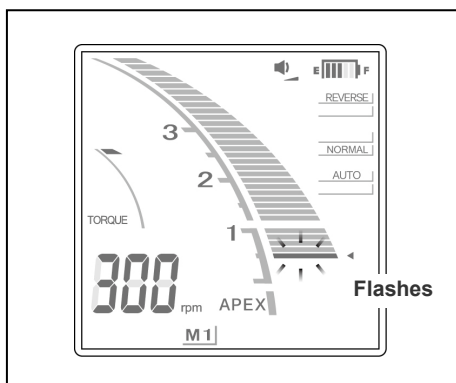

- * Refer to the separate manual for the Canal Measurement Module for instructions on how to measure a root canal.

The meter's 0.5 reading indicates that the tip of the file is in or very near the apical constriction.

- * The numerals on the meter gauge do not represent millimeters.

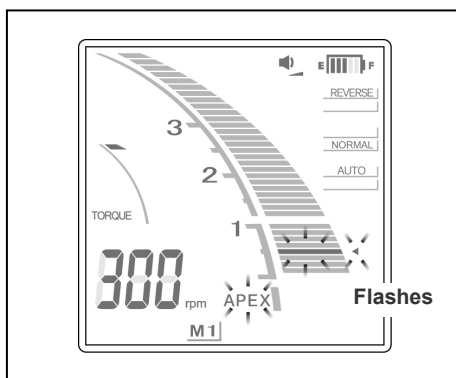

If the file tip passes the line specified by the apical line, the alarm sound will change from beeping to a solid tone. When the file tip reaches the major foramen, the alarm will change to a single sustained beep, and the word "APEX" and the little triangle next to the apical line will start to flash.

Operating the Motor Handpiece

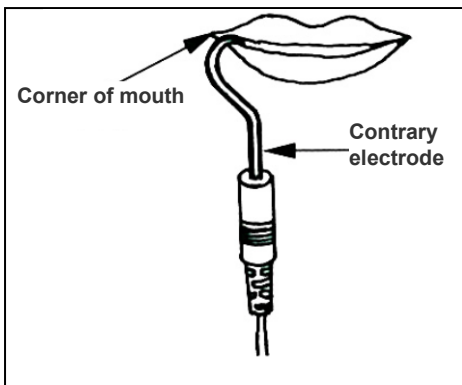

1. Hook the contrary electrode in the corner of the patient's mouth.

⚠ WARNING

- *Do not use an ultrasonic scaler with the contrary electrode attached to the patient. This is dangerous because electrical noise from the scaler could interfere with canal measurements and motor operation.*
- *Make sure that the contrary electrode, file holder, handpiece file electrode etc., do not come into contact with an electric power source such as an electrical socket. This could result in a severe electrical shock.*

⚠ CAUTION

- *The contrary electrode could cause an adverse reaction if the patient has an allergy to metals. Ask the patient about this before using the contrary electrode.*
- *Take care that medicinal solutions such as formalin cresol (FC) or sodium hypochlorite do not get on the contrary electrode or the file holder. These could cause an adverse reaction such as inflammation.*

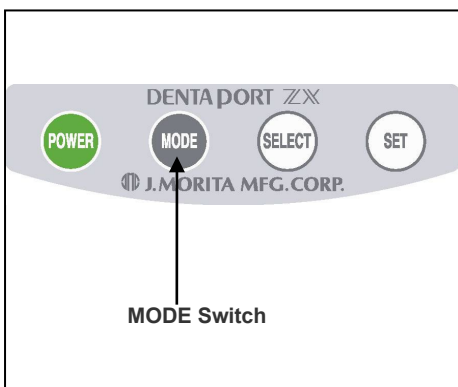

2. Press the MODE switch and select M1, M2, or M3.

- * See pages 25 and 27 for how to set the memory contents.
- * During actual root canal preparation, none of the switches will work except the POWER switch.

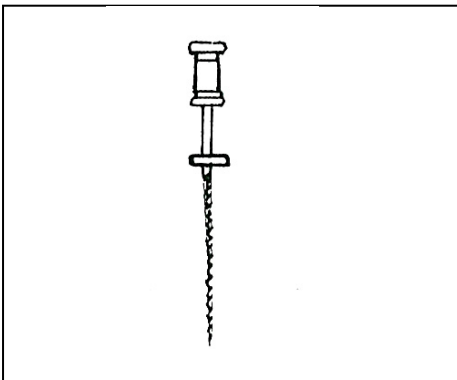

- * Before using the motor handpiece, use a small file, such as #10 or #15, to penetrate the root canal manually down to the apex and then return to the apical constriction.

3. The file will automatically start to rotate when it is inserted into the root canal (Auto Start)*. If the root canal is extremely dry, the auto start function may not operate.

CAUTION

- *If the auto start function does not work because the root canal is too dry (infected canal etc.), moisten the canal with a liquid such as hydrogen peroxide, sodium hypochlorite or saline.* Do not let the liquid overflow the canal opening.*
- *Applying excessive force could cause the file to cut into the root canal wall and lock up.*

4. If the unit is set for auto apical reverse, the file will stop and reverse its rotation when the file tip reaches the point specified by the reverse position setting (Auto Apical Reverse). Or if it is set for apical stop, the file will stop when the file tip reaches the point specified by reverse position setting. A single sustained beep will sound when this happens*.
5. If more than the specified amount of the torque is applied to the file, the file will automatically reverse its rotation (Auto Torque Reverse). A three-toned alarm will sound when this happens.
6. The file will stop to rotate when it is removed from the root canal (Auto Stop). Gradually increase the size of the file until the root canal preparation is completed.
7. If necessary, prepare the apical seat.

* This works only when the link to the canal measurement function is turned on.

* Motor Overheating

To protect the unit from serious internal damage, the motor handpiece stops running if the motor gets too hot. In this case, the entire display flashes on and off and none of the controls will work, the motor handpiece will start working again once it cools off.

WARNING

- *If the motor overheats, take the handpiece out of the patient's mouth immediately, and wait until it cools down to resume treatment. Do not leave it inside the patient's mouth; this could result in an injury because it might start running unexpectedly when it cools down.*

CAUTION

- *The motor may overheat if an excessive load is applied.*
- *If the motor gets hot, do not disconnect the motor from its handpiece cord. If a hot motor has been disconnected from its handpiece cord, wait for at least 10 minutes before reconnecting it.*
- *Even if the motor has cooled down enough to operate, it could still be rather hot and excessive loads should not be applied to it.*

* While an overheated motor is cooling down, the power cannot be turned off. "O.H." appears in the display and the unit will not be turned off even with pressing the POWER switch. The unit will automatically turn off after the motor has cooled down. Simply press the POWER switch to turn it back on.

WARNING

- *Electric noise or a malfunction could make it impossible to control the motor properly. Do not depend entirely on the unit controlling itself; always watch the display, listen to the sound and be aware of tactile feedback.*
- *Accurate measurement is not always possible depending on the root canal condition. Make sure to take an X-ray to check the results. Also nickel-titanium files can sometimes wear out rather quickly depending on the shape and the degree of curvature of the root canal. Stop using the unit immediately if it does not seem to be working properly.*
- *If the display does not change when the file is advanced down the canal, stop using the instrument immediately. There times, such as faulty connections etc. when an accurate measurement cannot be made.*
- *Nickel-Titanium files are more easily broken by the amount of torque applied to them than stainless steel files. Do not try to force the file down the root canal. Also do not use these files for the root canals that have a relatively sharp curve near the apical foramen.*
- *Nickel-Titanium files will eventually break due to metal fatigue and should be replaced before they reach this point.*

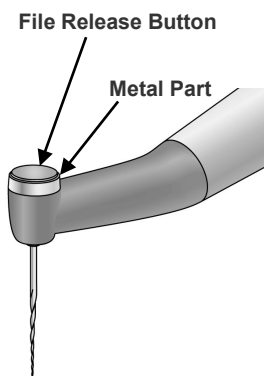

- *Always examine files for separation and other deformities or damage before using them. Any type of deformity could result in the file breaking.*
- *If the file touches the oral mucosa or a tooth, it will automatically start to rotate and could injure the patient.*
- *Do not touch the oral mucosa with the metal part at the end of the contra angle. The motor handpiece could start up and injure the patient or the instrument might not make accurate measurements.*
- *If the contra angle's file release button is pressed against the teeth opposite the one being treated, the file could come out and injure the patient.*
- *Never press the file release button while the motor handpiece is running. This could cause the button to heat up and burn the patient or cause the file to come out and injure the patient.*
- *Some files cannot use the built-in electrode to make measurement; always check for conductivity before using a file. If there is no conductivity, replace the cap with the one with an external file electrode.*
- *Do not use reciprocal files (ones made to rotate back and forth). These could perforate the apical foramen when they reverse rotation.*

CAUTION

- *Root canal preparation cannot be performed entirely with this unit; use this unit in conjunction with standard manual techniques for root canal preparation. Stop using the unit immediately if tactile sensation indicates an unusual or abnormal condition inside the root canal.*
 - *Files break more easily at high speeds; always check the rotation speed setting before using the unit.*
 - *Use only Ni-Ti or properly designed stainless steel files.*
 - *Always remove the file after use.*
- * For difficulty to reach areas, such as maxillary molars, it may be easier to insert the file into the root canal before activating the motor handpiece power; remove the contrary electrode from the patient's mouth and then insert the file. Then hook the contrary electrode back in the corner of the patient's mouth to start the file rotating.
- * Electrical noise will cause the motor to stop and automatically put DENTAPORT ZX into the root canal measurement mode, which is the safest mode. However, it will return to normal operation when the file is taken out of the root canal.

CAUTION

- *Nickel-Titanium files are more easily broken by the amount of torque applied to them than stainless steel files. Keep the following points in mind to minimize the possibility of file breakage.*
 - *Before using motor handpiece, use a small hand file, such as #10 or #15, to penetrate the root canal manually down to apex and then return to the apical constriction.*
 - *Never use excessive force to insert the file.*
 - *All foreign matter, such as bits of cotton, should be removed from the root canal before using the file.*
 - *Never use excessive force to advance the file down the root canal.*
 - *Do not use the files on the root canals that have a high degree of curvature.*
 - *Try not to trigger the auto torque reverse function when advancing the file down the root canal.*
 - *The recommended technique for preparing and cleaning the root canal is crown down technique. When using this technique, follow the file manufacturer's guideline.*
 - *If you encounter resistance or the auto torque reverse is triggered, back the file up 3 or 4 mm and carefully advance it down the root canal again. Or replace the file with a smaller size. Never use excessive force.*
 - *Do not force the file down the root canal or press it against the root canal wall as it could break the file.*
 - *Do not use the same file continuously for more than 10 seconds in one position as it may create "steps" on the root canal wall.*
- * Washing the root canal out with a chemical solution during instrumentation helps stable and consistent file action.
- * After root canal preparation, clean the root canal out ultrasonically.
- * If necessary, make minor alterations to fit the Gutta-Percha point.

Manual Mode Using the Foot Switch

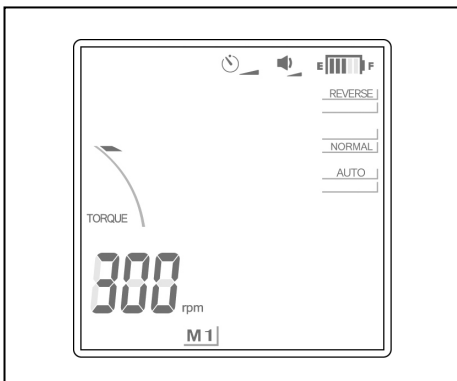

When the foot switch is depressed the motor runs at the set speed. (If the file is outside the canal, the meter in the display will disappear.)

The motor stops when the foot switch is released.

WARNING

- *Be careful using the foot switch. The motor will rotate even if a measurement is not being made. Make sure of the position of the file tip before using the foot switch.*

CAUTION

- *Be careful using the foot switch because the motor will run when you step on it even if the unit is not measuring the root canal. This could injure the patient's oral mucosa.*
- *Also be careful using the foot switch if the measurement display does not appear, such as when measuring an extremely dry canal, because the motor will run even if a measurement is not being made.*

Manual Mode Using the Operation Switches

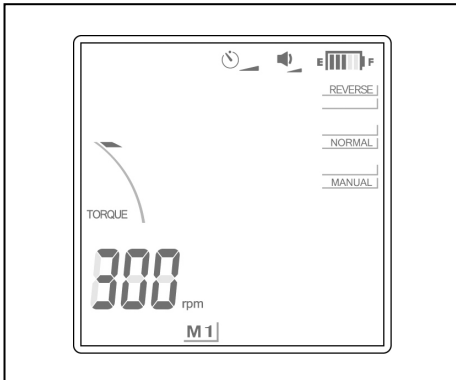

Forward Rotation

With the file outside the canal and the motor stopped, hold down the SET switch and then press the MODE switch. (Do not reverse the switch order; this would go into the Memory function.) The file will rotate forwards at the specified speed. The canal length meter in the display will disappear, and AUTO will change to MANUAL. (However, the auto torque reverse will still work.) To turn off the manual forward rotation mode, press the SET switch, or step on the foot switch and release it. If you put the file in a canal and make a measurement, manual mode will be canceled and the unit will return to normal operation.

⚠ CAUTION

- *Be careful if the measurement display does not appear, such as when measuring an extremely dry canal, because the motor could start up even if a measurement is not being made.*

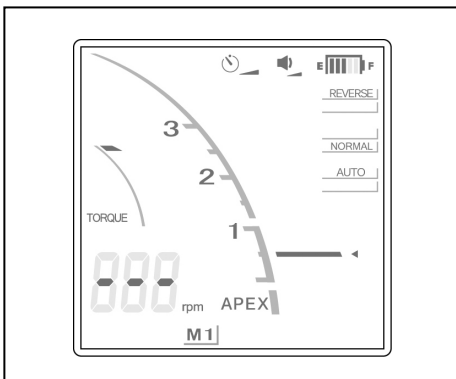

Reverse Rotation (to release locked file)

If the motor stops because the file is locked inside the root canal, take off the contrary electrode, hold down the SET switch and then press the SELECT switch. (Do not reverse the switch order; this could change the memory contents.) The file will rotate in reverse direction at the maximum speed for about 0.5 seconds and then slow down to normal speed. This function is effective for releasing the locked file. To turn off the forced reverse rotation function, press the SET switch, or step on the foot switch and release it.

⚠ CAUTION

- *Use the reverse rotation mode carefully. Since it is designed to release the locked file, its rotation is quite fast and powerful, and may easily break the file.*

* Motor Lock

When the file is engaged too deeply in the root canal, the motor stops and the file can no longer rotate. After about 2 seconds the lock on the motor is automatically released and the motor restarts to operate. If it does not, disengage the contrary electrode and run the motor in reverse to release the file, or turn the unit off and remove the file manually.

Replace Built-in Electrode with Cap with External File Electrode

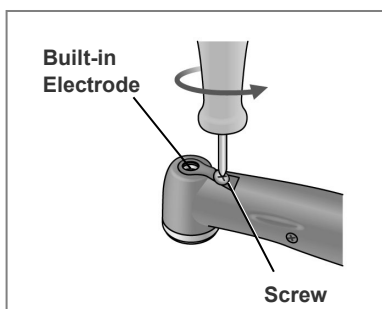

If there is no electrical conductivity between the file and its shank, replace the cap with the one that has an external file electrode (sold separately).

(1) Loosen the screw and take off the built-in electrode.

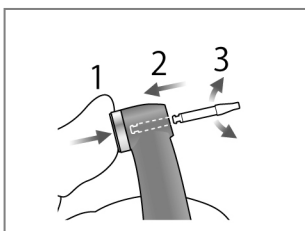

(2) Hold the push button and slide the guide bar straight in as shown in the illustration. Then rotate it left and right.

⚠ CAUTION

- *Always use the guide bar and make sure it will not come out. If the guide bar is not properly fix in place, the internal contact could be bent, and then the instrument might not be able to make accurate measurements or else it might malfunction.*
- *Do not run the motor with the guide bar inserted; this could damage the instrument.*

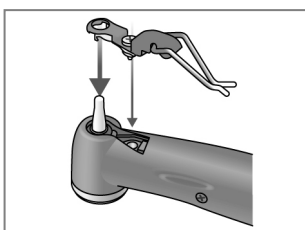

(3) Slide the cap with the electrode onto the guide bar and line up the screw holes.

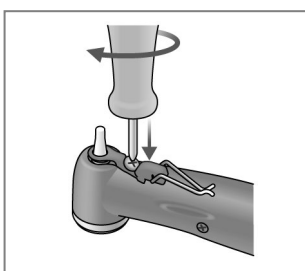

(4) Slowly turn the screw and make sure the cap goes into the head properly.

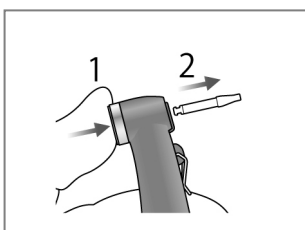

(5) Tighten the screw up securely and then hold down the push button and pull out the guide bar.

⚠ WARNING

- *Make sure the screw is tight enough. Otherwise, it might come out and be swallowed. Also, measurements might not be accurate.*

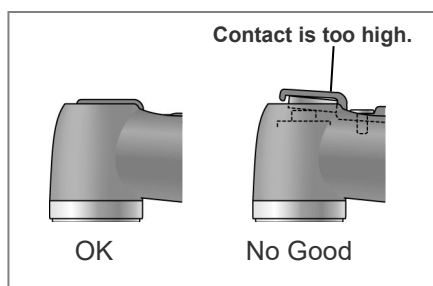

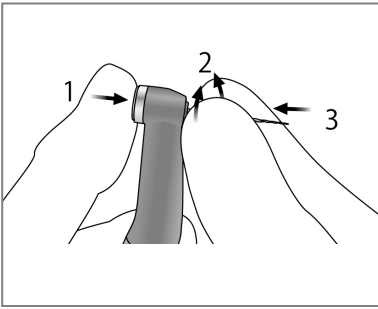

- (6) Hold the push button down and turn the file back and forth until it lines up with the notch and goes all the way in. Release the button to secure it.

⚠ WARNING

- **Make sure the file goes all the way in. Give it a light tug to make sure it is held securely.**
- **Never use stretched or otherwise damaged files.**

⚠ CAUTION

- **Never put file in or take them out without pressing the button down. This could damage the chuck. Always hold the button down to put a file in or take it out.**
- **Use only Ni-Ti or properly designed stainless steel files.**
- **Be careful not to cut your finger when putting files in and taking them out.**

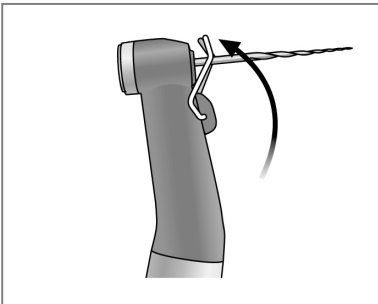

- (7) Lift the electrode up and clip it onto the file.

⚠ CAUTION

- **Do not let the cutting part of the file touch the electrode; this will wear it out very quickly.**
 - **Some files cannot be used with this electrode.**
 - **Also the Ni-Ti files noted below cannot be used.**
 - **Those with a file diameter of more than 1.2 mm.**
 - **Those with chuck shanks that are not perfectly round**
 - **Gates-Glidden Drills**
 - **Those that have cutting sections with large diameters such as largo burrs**
- To use these types of files, do not clip on the electrode and use the motor in manual mode.
- **Do not use files with shanks larger than the ISO standard. ISO Standard: Diameter 2.334 to 2.350 mm**
 - **After use, do not fail to take the file out.**

* Always clip the electrode on the file when using it. Otherwise, measurements may not be accurate or rotation may not be properly controlled. (It may not be possible to measure a canal if blood or some other liquid overflows the canal or if the canal is completely blocked.)

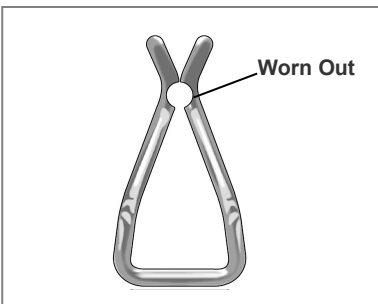

⚠ WARNING

- **Make sure the screw is tight enough. Otherwise, it might come out and be swallowed. Also, measurements might not be accurate.**
- **Replace the external file electrode if it is worn out as shown in the photo to the left.**

Light Cure

⚠ WARNING

- *If there is a lightening storm while the battery is being charged, do not touch the main unit, the AC adapter or the main power cord; you could get a shock.*

⚠ CAUTION

- *Stop using the instrument and have it repaired if the display does not appear properly or if the instrument suddenly turns off (except in the case where it automatically turns itself off after 10 minutes of not being used).*

Overview of Features and Functions

Irradiation Switch

This switch turns the light on and off.

The light runs off automatically when the set time has elapsed.

A foot switch can also be used to turn the light on and off.

Time Settings

Irradiation times of 10 or 20 seconds can be selected. Also other times can be set manually.

Change the setting as necessary. (The time setting will be memorized and not change even when the instrument is turned off.

Irradiation at a Distance

The light is effective at a distance of up to 10 mm.

This means the light can be used effectively even when it is hard to position it near the tooth surface, when hardening a fiber post for example.

Liquid Crystal Display and Switches

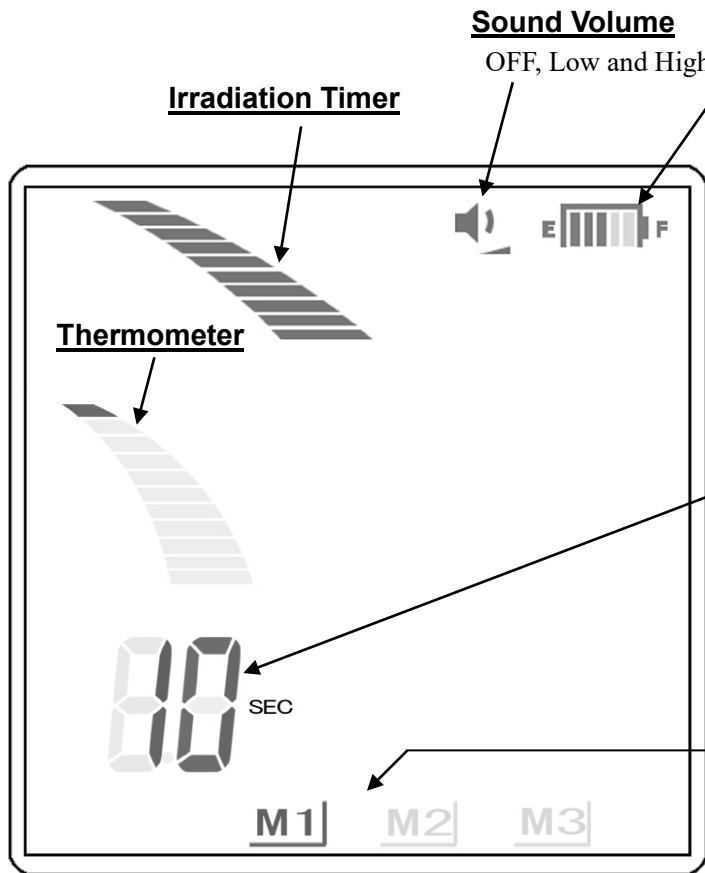

Sound Volume

OFF, Low and High

Battery Power Indicator

Shows how much power is left.

⚠ CAUTION

- Charge the battery as soon as the indicator gets down to the last two bars.
- Never use the unit when the battery power display is flashing. The motor will not operate when this display is flashing.

Irradiation Time Setting

Shows Set Time
(5, 10, 15, 20, 25, 30, 35, or 40 sec.)
(Counts down during use)
* "000" indicates manual mode.
(Shows irradiation time during use.)

Memory (M1, M2 and M3)

Refer to the section "Setting and Changing Memory" for details.

- * Not displayed when measuring a canal with the light connected. If the light is disconnected, M1, M2, and M3 will represent the memories for the canal measurement module. Refer to the operation manual for the Canal Measurement Module.

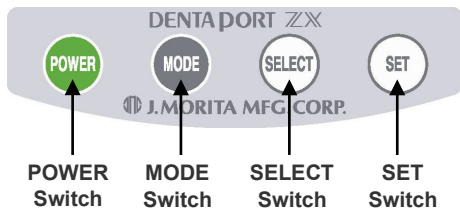

⚠ CAUTION









- Each memory will have its own unique settings.

⚠ CAUTION

- Press the switches firmly. If a switch is not held down long enough, it may not work even though a beep sounds.

Setting and Changing Memory

Use the MODE switch to select M1, M2, or M3. Use the SELECT switch to select beeper volume or irradiation time. Use the SET switch to set the memory contents.

 Select the memory.	 Select the function (The display will briefly flash on and off.)	 Set the memory content. * Press when blinking.
<p>M1 (memory 1) → Light Cure Mode 1 ↓ M2 (memory 2) → Light Cure Mode 2 ↓ M3 (memory 3) → Light Cure Mode 3</p>	<p>Sound volume selected</p>  <p>Flashes</p>  <p>Flashes</p>	<p>Turn sound off.</p>  <p>↓</p> <p>Set sound volume low</p>  <p>↓</p> <p>Set sound volume high</p>  <p>5 10 15 20 25 30 35 40 000</p> <p>Irradiation Time Setting (seconds)</p> <p>(Manual Irradiation)</p>
<p>No display</p> <p>Root canal measurement mode*</p>	<p>* For how to make settings for root canal measurement, refer to the separate user's manual for the root canal measurement module.</p>	

* All memory settings will be retained even after the unit is turned off. Simply select M1, M2, or M3. If the light cure is connected when the power is turned on, M1 will be the selected memory. (If the motor handpiece is not connected, the memory selected when the unit is turned on will be the canal measurement memory last used.)

* If the memory display does not appear, the unit is set for root canal measurement.

WARNING

- Check the settings displayed after selecting memories.

Operation

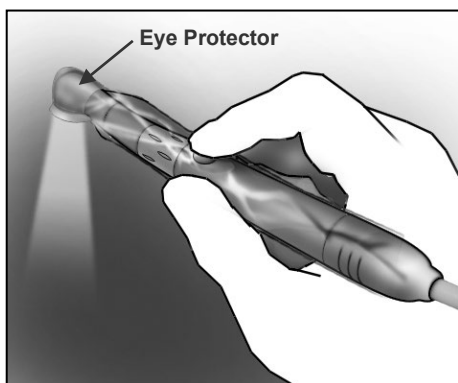
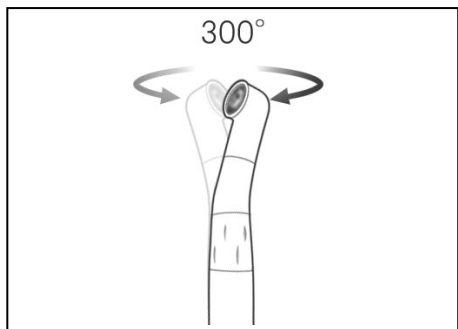
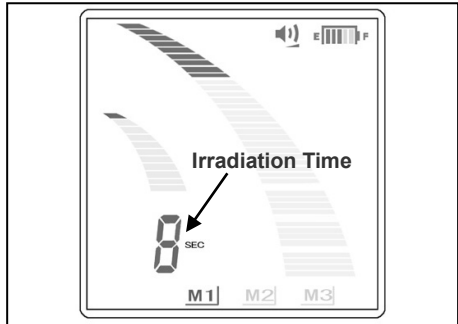
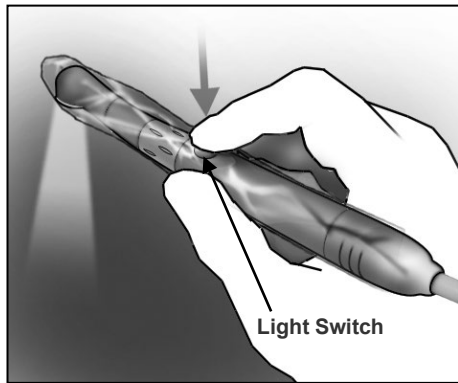
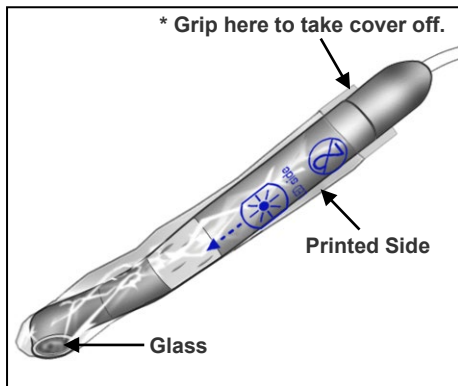

Put the disposable cover on with the printed side on the same side as the glass.

- * For optimum effectiveness, the shape of the disposable cover matches the shape of the head. This makes it a tight fit and it may seem to go on with a little difficulty.

⚠ WARNING

- *For effective infection control, do not fail to use a disposable cover. A new, uncontaminated disposable cover must be used for each patient to prevent from cross-contamination. Make sure it is not torn or damaged. Covers also protect the patient from swallowing chips etc. In case the glass is damaged.*

Press the Light Switch to use the instrument.

The light can also be turned on and off with the foot switch.

- * The countdown timer will start when the light is turned on.
- * In manual mode, the timer will show how long the light has been on.
- * Press the Light switch or the Foot switch again to turn the light off.

⚠ WARNING

- *Never shine the light into the patient's eye. Never stare at the area being irradiated. Either of these actions could harm the eyesight.*

The head rotates 300° to reach to treatment area.

⚠ CAUTION

- *The head does not come off; do not pull on it.*
- *Do not try to rotate the head beyond its limit.*

- * Use the eye protector (Sold separately) so that the irradiated area is not directly visible.

[Thermometer]

The thermometer shows the temperature of the head.

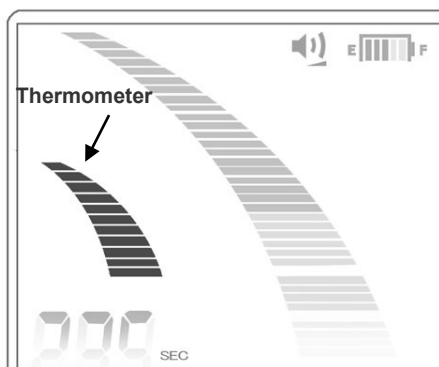

Bars	Condition
1	Light can be used for a considerable time
4	Getting warmer
7	Light might turn off at this point
11	Too hot to use * Wait until head cools off

⚠ WARNING

- *Ask the patient if the light is too hot. If the patient complains, hold the light a little farther away.*
- *Take care not to bump or bang the glass against a hard object. It might crack and a fragment could be swallowed by accident. Never use the light if the glass is cracked or chipped.*

⚠ CAUTION

- *Long continuous use can cause the head to heat up. Do not touch the oral mucosa with it.*

[Safety]

The light will suddenly turn off because of safety concerns if one of the following conditions occur.

- If the head gets too hot
 - The thermometer goes all the way up.
 - Timer will show remaining time in normal mode or total irradiation time in manual mode.
 - When the head cools off, the instrument will return to normal operation.
 - If the light turns off too soon, repeat the irradiation.
 - If the battery loses power
 - The battery drops to just one bar
 - Timer will show remaining time in normal mode or total irradiation time in manual mode.
- * If the light suddenly goes out because the head is too hot, the head can be cooled off more quickly by blowing air on it.
(Do not use water to cool the head; this could damage the instrument.)

⚠ CAUTION

- *In some cases, after the light turns off because of low battery power, the battery will go back up to two bars right away and the light will work again. However, the light will quickly turn off again. The battery should be charged right away.*
- * The pattern shown below sometimes appears when irradiating at a distance. However, the polymerizing effect of the light is not impaired in any way.

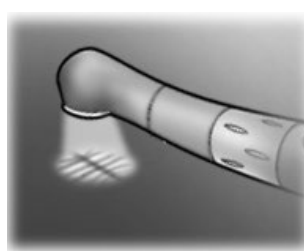

6. After Using the Unit

a. Turn Main Switch Off

Turn the unit off after use.

- * The unit will automatically turn off after 10 minutes of non-use.
- * Wait at least 3 seconds after the power goes off before turning it back on again.
- * Do not turn the power on while stepping on the foot switch.

b. Disconnect

Disconnect the handpiece cord, contrary electrode and the foot switch.

⚠ CAUTION

- *When disconnecting and connecting the handpiece cord, contrary electrode and foot switch, never pull or push on the cords themselves; always grip the connectors.*
- *Do not wrap the handpiece cord around the body of the main unit.*

(When a file is installed)

Hold down the file release button on the contra angle and pull the file straight out.

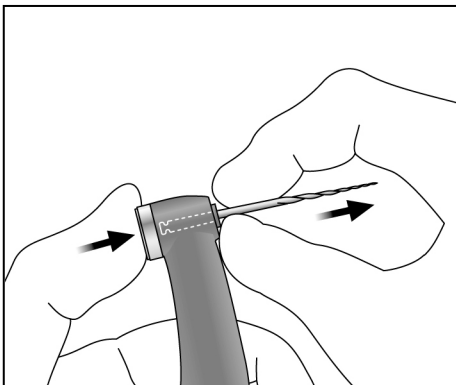

⚠ CAUTION

- *Use caution when inserting and removing files to avoid injury to fingers.*
- *Inserting and removing files without holding down the file release button will damage the internal contra angle mechanism.*

c. Charging Battery

The battery is built into the Canal Preparation and Light Cure Module. Recharge it as soon as the battery power indicator is down to 2 lines.

⚠ CAUTION

- *Do not use the unit if the battery indicator is blinking. The motor and light cure handpieces will not work if this indicator is blinking.*
- *If "Lo.b" appears in the speed (timer) display, the battery is extremely low. Stop using the instrument and charge the battery.*
- *If the plug for the AC adapter does not fit the socket, it is the user's responsibility to find a suitable plug adapter.*
- *Use only the AC adapter made for DENTAPORT ZX.*

- * The motor handpiece and light cure will still operate when the battery power indicator bar goes down to one line and starts flashing. However, these instruments will stop operating once battery power is completely out. Turn the power off and charge the battery.

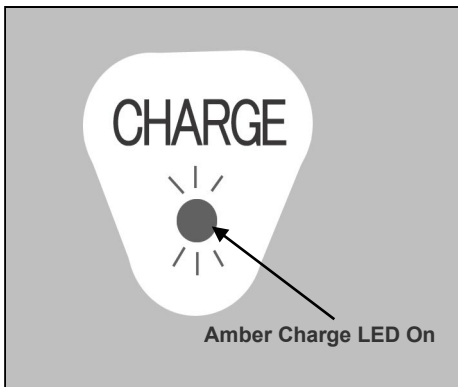
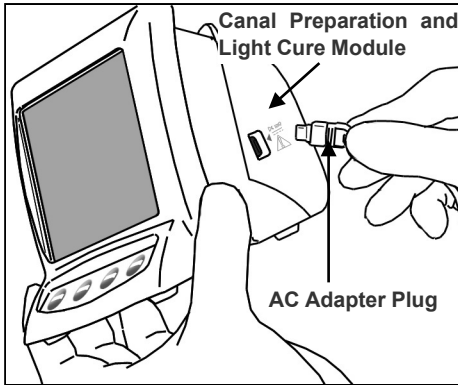

1. Line up the arrow on the AC adapter's connector with the small triangle above its jack on the side of the Canal Preparation and Light Cure Module and plug it in. Then plug the adapter into the electrical power receptacle.

⚠ WARNING

- *Do not use the unit when the AC adapter is connected.*

2. The amber Charge LED on the back of the Canal Preparation and Light Cure Module starts flashing on and off and then, after a few seconds, it will stop flashing and stay on to show that the battery is being charged. It takes about 60 minutes to fully charge the battery.

⚠ CAUTION

- *If [F.02] appears in the display, noise has been detected. Turn the unit off and then back on again. If [F.02] still appears, stop using the unit and contact your local dealer or the J.MORITA OFFICE.*

3. Amber Charge LED goes out when the battery is fully charged.
4. Disconnect the AC adapter from the Canal Preparation and Light Cure Module and unplug it.

⚠ WARNING

- *Never operate the unit with an external power supply.*
- *If an electrical storm occurs while the battery is being charged, do not touch the AC adapter or the charger's power supply cord as there would be a risk receiving an electric shock.*
- *The AC adapter must be located outside the so called patient environment (2.0m around the patient location) when the AC adapter is connected.*

⚠ CAUTION

- *Do not pull or yank the cord when disconnecting the AC adapter.*

For Optimum Battery Performance

1. The battery may lose its ability to hold a charge for the normal length of time if it has not been used for a long time or if it is recharged before each use.
[This is due to its deactivation (dull charging response) or to what is called the "memory effect".]
Its normal working condition can be restored in the following way:
 - a. Use the manual mode to run the motor until "Lo.b" (low battery) appears in the display and the motor stops running so that the battery is completely discharged.
 - b. Connect the AC adapter and recharge the battery in the normal way.
 - c. Repeat this process (steps a and b above) two or three times.
2. It's possible that a newly purchased battery will require the charging procedure described above before it will hold a charge for a normal length of time.
3. Ambient (room) temperature for charging is from +10 °C to +40°C (+50 °F to +104°F).
 - * Sometimes the battery may recharge more quickly than usual. If the time it takes for recharging the battery seems too short, recharge it a second time just in case.
 - * If the battery has not been used for a week or more, it will have lost its charge and need to be recharged.
 - * Replace the battery if it seems to be running out of power sooner than it should.

7. Maintenance

* The LS oil container has changed. Do not fail to follow the procedure below when performing autoclave sterilization.

Be sure to follow the procedure below when performing daily maintenance.

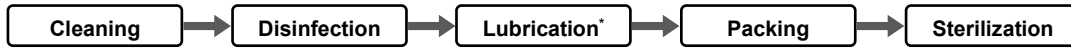

a. Autoclavable Components

- Components maintained this way:



Contra Angle



Contrary Electrode



Handpiece Rest

⚠ CAUTION

- *Before cleaning the contra angle, do not fail to take out the file.*

■ Cleaning

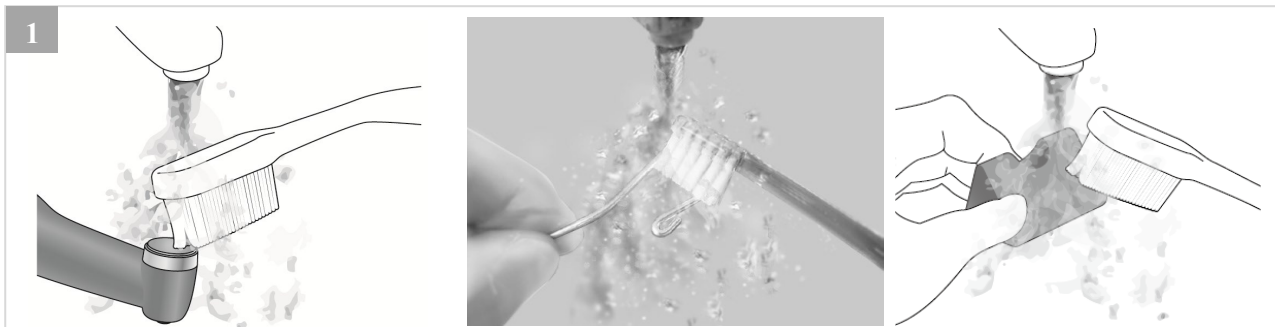

Disconnect the contra angle from the motor handpiece.

Clean off the cutting debris in running water with a soft brush and then wipe off the water.

⚠ CAUTION

- *If a medical agent being used for the treatment has adhered to the components, wash it off in running water.*
- *Do not clean the components ultrasonically.*

2

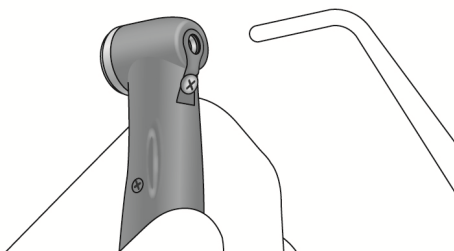

Dry the contra angle including its inside with air from the syringe or by another such method.

⚠ CAUTION

- *Check to see if the contra angle, including its inside, is completely dry. If any water remains inside the component, expel it with an air gun or another such tool. Failure to do so could result in the remaining water coming out during use and cause malfunction, or poor lubrication and sterilization.*

■ **Disinfection**

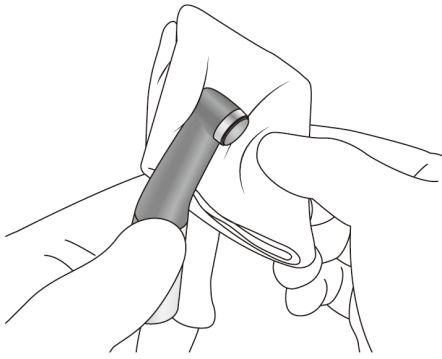

Wipe the components with a piece of gauze that has been dampened with Ethanol for Disinfection (Ethanol 70 vol% to 80 vol%) and wrung out thoroughly.

⚠ CAUTION

- *Do not use anything except ethanol. Do not use too much ethanol; it could seep inside and damage the contra angle.*
- *Never wipe the contra angle with corrosive solutions such as electrolytic acids, strong alkaline solutions, or other special cleaning solutions commonly available.*



Operating conditions for high-temperature washer-disinfectors

* When using a high-temperature washer-disinfector to clean the handpiece, strictly adhere to the conditions specified below.

High-temperature cleaning conditions

Unit Name	Mode	Detergent (Concentration)	Neutralizer* (concentration)	Rinse (concentration)
Miele G7881	Vario TD	neodisher MediClean (0.3% to 0.5%)	neodisher Z (0.1% to 0.2%)	neodisher MiecClear (0.02% to 0.04%)

* After cleaning there may be streaks or white spots on the contra angle. Use a neutralizer only if there are streaks or white spots.

Operating Precautions

- Always use a handpiece holder when washing the contra angle, making sure to rinse the inside of the contra angle thoroughly.
- If any medical agent remains inside the contra angle, it may corrode, resulting in a malfunction of the contra angle.
- For details on handling medical agents or adjusting their concentration, refer to the user manual for the washing device.
- After washing is complete, check to see if the contra angle, including its inside, is completely dry. If any water remains inside the contra angle, expel it with an air gun or another such tool. Failure to do so could result in the remaining water coming out during use and cause poor lubrication or sterilization.
- Always lubricate the contra angle after washing.

⚠ CAUTION

- Inappropriate cleaning methods and solutions will damage the contra angle.
- Do not clean the contra angle using strong acidic or alkaline solutions that could cause the metal to corrode.
- Do not leave the components inside a high-temperature washer-disinfector.

■ Lubrication

1

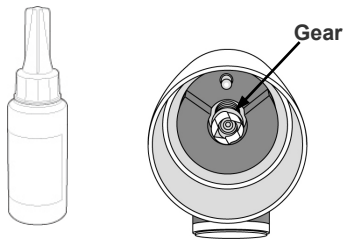

Put 5 drops of LS oil on the gear and wait for 10 minutes.

⚠ CAUTION

- *When lubricating the contra angle with oil, use only LS oil.*

2

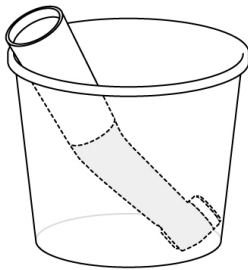

Place the contra angle in a paper cup with the connection end facing up and wait for 10 minutes.

⚠ CAUTION

- *Leave the contra angle in a paper cup for at least 10 minutes so that the oil is thoroughly absorbed by the contra angle mechanism.*
- *Put the cap on after use. Oil could seep out if the container is tipped over or the nozzle points down.*
- *After lubricating, wipe oil from the outside of the nozzle. Otherwise oil may seep out from under the cap.*
- *Send the contra angle up in the cup with the opening for the file facing down.*

3

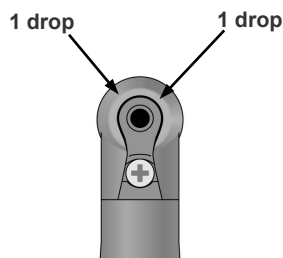

Put a drop of LS oil in each of the two points between the built-in electrode and the head as indicated by the arrows in the illustration.

4

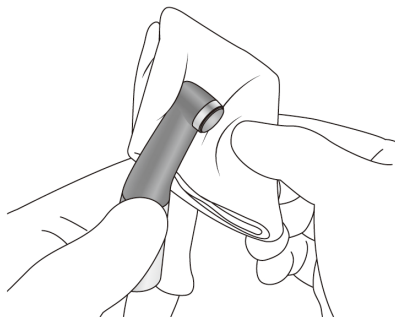

Take the contra angle out of the paper cup and wipe off any excess oil which may have seeped out.

⚠ CAUTION

- *The micromotor could be damaged if the contra angle is attached without allowing the excess oil to drain out first.*

To preserve optimal performance of the contra angle, we recommend cleaning and lubrication with LS Spray or MORITA MULTI SPRAY (sold separately)

- * Only the contra angle needs to be lubricated with the LS Spray or MORITA MULTI SPRAY.
- * We recommend using the Lubrina dental handpiece maintenance unit for lubricating the contra angle.

⚠ CAUTION

- *Do not use any type of spray other than the LS Spray or MORITA MULTI SPRAY.*
- *Failure to lubricate the contra angle will result in a malfunction.*

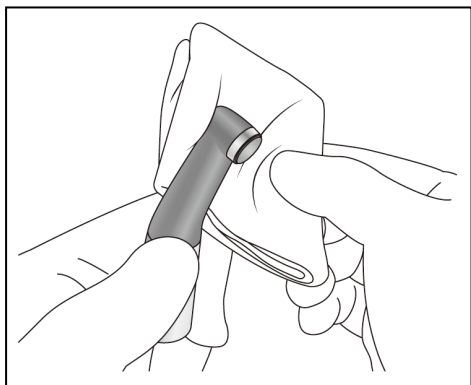

1. Cover the contra angle with a piece of gauze or other suitable cloth.

⚠ WARNING

- *Prevent spray from splashing into your eyes etc. by always covering the contra angle with gauze or suitable cloth.*

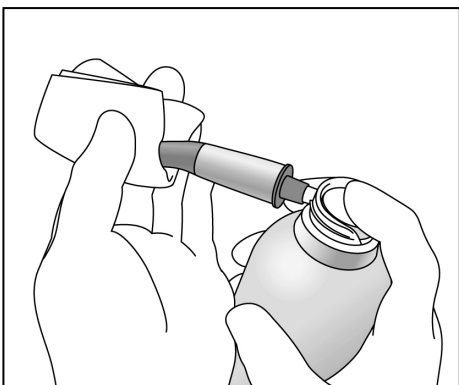

2. Screw the nozzle onto the spray can. Then insert it into the connection end of the contra angle, and spray for 2 seconds. Use gauze etc. to wipe excess spray off the outside of the contra angle.

⚠ WARNING

- *Never direct the spray towards a person.*
- *Never use the spray near an open flame.*
- *Hold both the contra angle and the spray can firmly when using the spray. Otherwise, the pressure of the spray could make the contra angle fly out of your hand.*

⚠ CAUTION

- *Always shake the spray can 2 or 3 times before using it. Use the can in an upright position.*

3. Stand the contra angle up on a piece of gauze to allow all the excess spray to drain out.

⚠ CAUTION

- *The motor handpiece could be damaged if the contra angle is attached without allowing the excess spray to drain out first.*

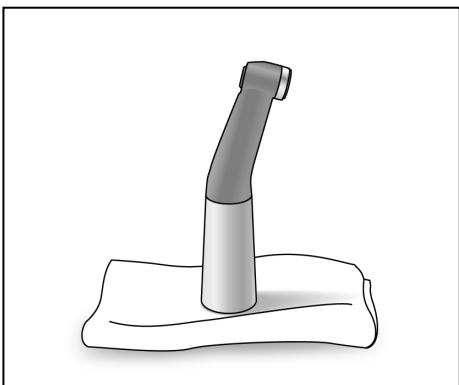

■ Packing

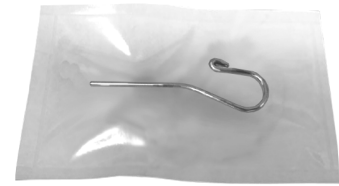
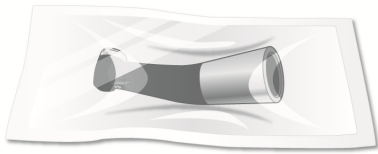

Individually place the contra angle, handpiece rest, and contrary electrode in a sterilization pouch.

■ Sterilization

Autoclave the components after use for each patient.

Recommended temperature and time:

+135°C (+275°F), 10 minutes minimum with a sterilization pouch.

Minimum drying time after sterilization: 30 minutes.

WARNING

- *To prevent the spread of infections, the components must be autoclaved after each patient's treatment has been completed.*

CAUTION

- *Do not sterilize the components by any method other than autoclaving.*
- *The components are extremely hot after autoclaving; do not touch until they cool off.*
- *Do not leave the components in the autoclave.*
- *Take the file out of the contra angle before autoclaving.*
- *For sterilizing files, follow the manufacturer's recommendations.*
- *Autoclaving and drying temperatures must never exceed +135°C (+275°F). Excess temperature could cause the contra angle to malfunction or could cause discoloration.*
- *Clean everything thoroughly before autoclaving. Any chemicals or foreign debris left on components could cause them to malfunction or could cause discoloration.*

b. Non-Autoclavable Components: Wipe with Ethanol

- Components maintained this way:



Motor Handpiece

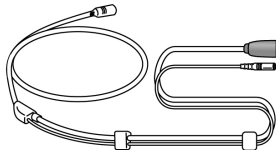

Handpiece Cord



Light Cure Handpiece
(Sold Separately)

Procedure:

Disinfection

■ Disinfection

Wipe the components with a piece of gauze dampened with Ethanol for Disinfection (Ethanol 70 vol% to 80 vol%).

CAUTION

- *Do not use anything except Ethanol for Disinfection (Ethanol 70 vol% to 80 vol%). Do not use too much ethanol as it could seep inside and damage the components.*
- *Do not immerse the components in or wipe it with any of the following: functional water (acidic electrolyzed water, strong alkaline solution, and ozone water), medical agents (glutaral, etc.), medicinal agents (glutaral, etc.), or any other special types of water or commercial cleaning liquids. Such liquids may result in plastic degradation, metal corrosion and adhesion of the residual medical agent to the components.*
- *Never clean the components with chemicals such as formalin cresol (FC) and sodium hypochlorite. These will damage the plastic parts of the components. If any of these liquids being applied to the components, wash it off in running water.*

c. Non-Autoclavable Components: Wash and then Wipe with Ethanol

- Components maintained this way:

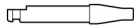

Guide Bar

Procedure:



■ Cleaning

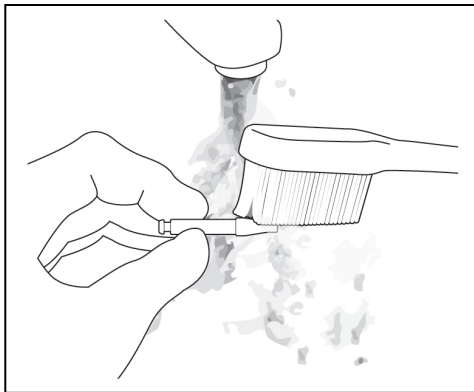

Clean off the cutting debris in running water with a soft brush and then wipe off the water.

⚠ CAUTION

- *Do not clean the component with an ultrasonic cleaning device.*

■ Disinfection

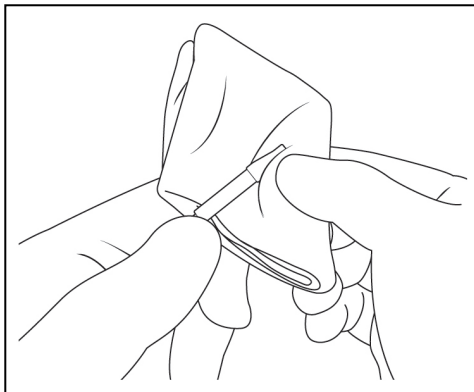

Wipe the component with a piece of gauze that has been dampened with Ethanol for Disinfection (Ethanol for 70 vol% to 80 vol%) and wrung out thoroughly.

⚠ CAUTION

- *Do not use anything except Ethanol for Disinfection (Ethanol 70 vol% to 80 vol%).*
- *Do not immerse the components in or wipe it with any of the following: functional water (acidic electrolyzed water, strong alkaline solution, and ozone water), medical agents (glutaral, etc.), medicinal agents (glutaral, etc.), or any other special types of water or commercial cleaning liquids. Such liquids may result in plastic degradation, metal corrosion and adhesion of the residual medical agent to the components.*
- *Never clean the component with chemicals such as formalin cresol (FC) and sodium hypochlorite. These will damage the plastic parts of the component. If any of these liquids being applied to the component, wash it off in running water.*

d. Non-Autoclavable Components: Wipe with Neutral Detergent and Moistened Cloth

- Components maintained this way:

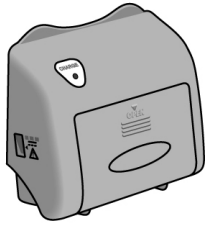

Canal Preparation
and Light Cure Module

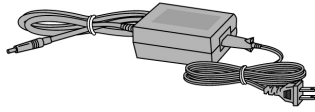

AC Adapter

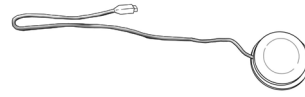

Foot Switch

Procedure:

Cleaning

To clean the surfaces of the components, use a soft cloth to apply a little neutral detergent, and then rinse them with a cloth moistened with water.

⚠ CAUTION

- *Do not use excessive amounts of detergent or water and do not soak the components.*
- *Do not use paint thinner, benzine or similar solutions to clean the components.*
- *Avoid spilling chemical solutions used for treatment on the components. These chemicals could damage, deform or discolor the module. Use extra caution to avoid spilling formalin cresol (FC) and sodium hypochlorite as they are quite strong. Wipe up any chemical spills immediately (Some chemicals may leave traces even if wiped up immediately).*

Rotor Axle and Built-in Electrode Cleaning Procedure

* If the bars flicker during use, or if all the bars in the meter do not light up when the file touches the contrary electrode, clean the rotor axle and the built-in electrode in the following way.

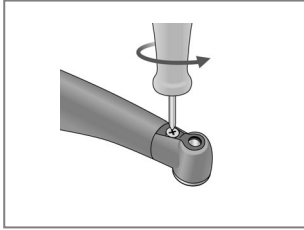

1. Take out the screw and then take out the built-in electrode.

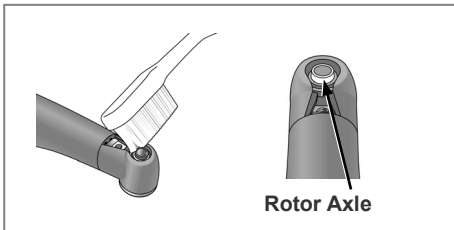

2. Put a little Ethanol for Disinfection (Ethanol 70 vol% to 80 vol%) on a brush and clean the rotor axle with it.

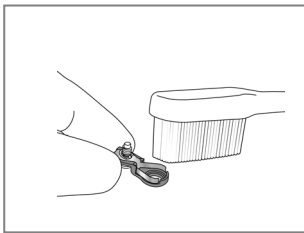

3. Clean the built-in electrode with the brush.

⚠ CAUTION

- *Do not bend or deform the electrode.*

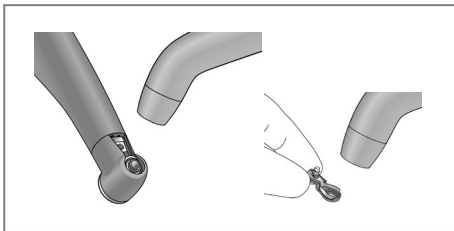

4. Blow air on the electrode to remove any remaining moisture.

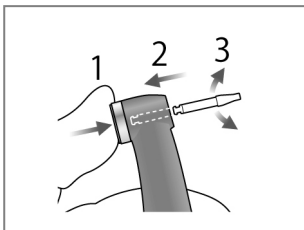

5. Hold the push button and slide the guide bar straight in as shown in the illustration. Then rotate it left and right.

⚠ CAUTION

- *Always use the guide bar and make sure it will not come out. If the guide bar is not properly fix in place, the internal contact could be bent, and then the instrument might not be able to make accurate measurements or else it might malfunction.*
- *Do not run the motor with the guide bar inserted; this could damage the instrument.*

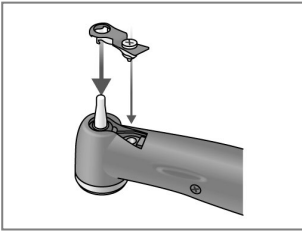

6. Slide the built-in electrode onto the guide bar and line up the screw holes.

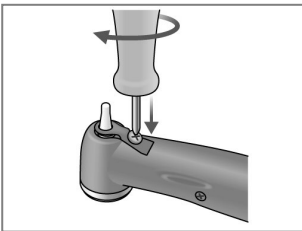

7. Slowly turn the screw and make sure the built-in electrode goes into the head properly.

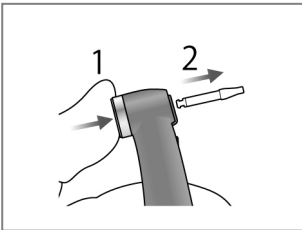

8. Tighten the screw up securely and then hold down the push button and pull out the guide bar.

8. Contra angle must be lubricated with LS Oil. Refer to page 47.

⚠ WARNING

- *Make sure the screw is tight enough. Otherwise, it might come out and be swallowed. Also, measurements might not be accurate.*

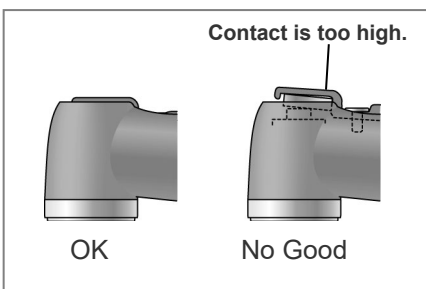

8. Replacement Parts, Transportation and Storage

- * Replace the parts as necessary depending on degree of wear and length of use.
- * Order replacement parts from your local dealer or the J. MORITA OFFICE.

Replace the built-in electrode

CAUTION

- *If the bars flicker during use, or if all the bars in the meter do not light up when the file touches the contrary electrode, and cleaning the rotor axle and built-in electrode does not solve this problem, then the built-in electrode is worn out and must be replaced with a new one according to the following procedure.*

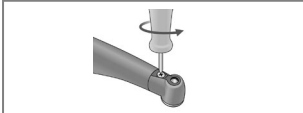

1. Take out the screw and then take out the built-in electrode.

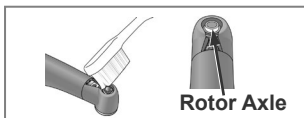

2. Put a little Ethanol for Disinfection (Ethanol 70 vol% to 80 vol%) on a brush and clean the rotor axle with it.

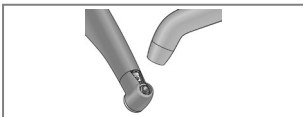

3. Blow air on the electrode to remove any remaining moisture.

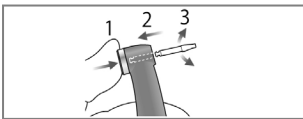

4. Hold the push button and slide the guide bar straight in as shown in the illustration. Then rotate it left and right.

CAUTION

- *Always use the guide bur and make sure it will not come out. If the guide bar is not properly fix in place, the internal contact could be bent, and then the instrument might not be able to make accurate measurements or else it might malfunction.*
- *Do not run the motor with the guide bar inserted; this could damage the instrument.*

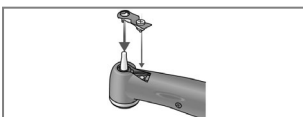

5. Slide the new built-in electrode onto the guide bar and line up the screw holes.

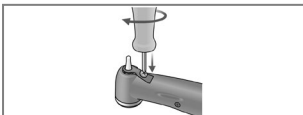

6. Slowly turn the screw and make sure the built-in electrode goes into the head properly.

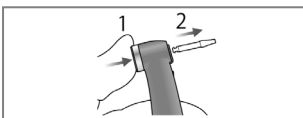

7. Tighten the screw up securely and then hold down the push button and pull out the guide bar.

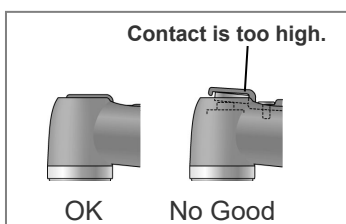

8. Contra angle must be lubricated with LS Oil. Refer to page 47.

WARNING

- *Make sure the screw is tight enough. Otherwise, it might come out and be swallowed. Also, measurements might not be accurate.*

Replacing the Battery

The battery will last for approximately 1 year under normal circumstances and use. Replace it when it starts to lose power relatively quickly after being fully charged.

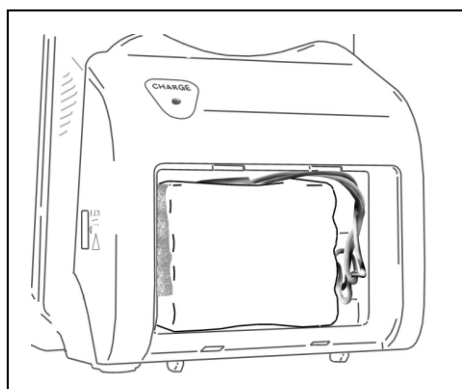
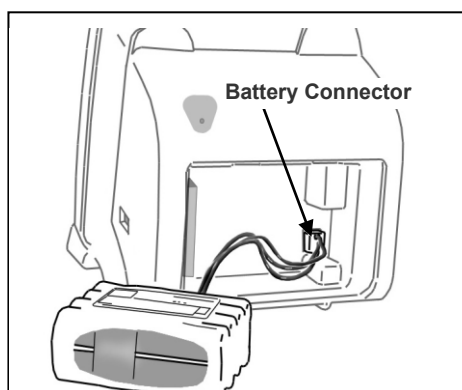
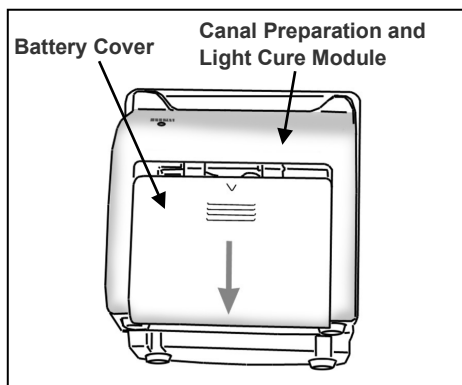

⚠ CAUTION

- *Use only the battery that is specially designed for the DENTAPORT ZX Canal Preparation and Light Cure Module.*

*This battery can be ordered from your local dealer or from J. MORITA OFFICE.

1. Turn power off.
2. Slide the battery cover off the back of the Canal Preparation and Light Cure Module in the direction indicated by the arrow in the illustration.
3. Remove the expired battery and disconnect it.

⚠ CAUTION

- *Do not disconnect the battery while the power is ON.*

4. Connect the new battery and place it in the Canal Preparation and Light Cure Module.
5. Place the battery cover back on the Canal Preparation and Light Cure Module.

⚠ CAUTION

- *Be careful not to pinch the battery cord when replacing the cover.*
- *Always use the specified battery. Other batteries might overheat.*
- *Do not use a battery if it is leaky, deformed, discolored or if its label is peeled off. It might overheat.*
- *Dispose of old battery in an environmentally safe way and in strict accordance with local regulations.*

Transportation and Storage

* Store the unit where it will not be exposed to X-rays or direct sunlight and where the ambient temperature range is between -10°C and +70°C (+14°F and +158°F) (-10°C to +45°C / +14°F to +113°F for battery); humidity between 8% and 80% (without condensation); and atmospheric pressure between 70 kPa and 106 kPa.

* If the unit has not been used for a long time, make sure it works properly before using.

* Always remove the battery prior to storing or shipping the unit.

9. Inspection

Regular Inspection

*This instrument should be inspected every 6 months in accordance with the following maintenance and inspection items.

Maintenance and Inspection Items

1. Check that the battery does not seem to be losing its charge too quickly.
2. Check that the MODE switch changes the memory from M1 to M2 to M3 etc.
3. Check that the Select and SET switches work properly.
4. Check that the handpiece cord can be properly connected to its jack on the side of the Canal Preparation and Light Cure Module and that the contrary electrode can be properly connected.
5. Check that the connection end of the motor handpiece is clean and not damaged and that it can be properly connected to the handpiece cord.
6. Check that the connection end of the contra angle is clean and not damaged and that it can be properly connected to the motor handpiece. Also check that the push button works and a file can be properly installed.
7. Check that the connection end of the light cure handpiece is clean and not damaged and that its handpiece cord can be properly connected.
8. Make sure the glass for the light cure handpiece is not dirty, chipped or cracked.

Parts Lists

Component	Description	When
Contra Angle	See section on how to attach the contra angle.	When head does not rotate properly
AC Adapter	AC Adapter	When battery charging can no longer be performed properly
Handpiece Cord	Handpiece Cord Assembly	When motor does not rotate properly
Battery	See section on how to replace the battery.	
Built-in Electrode or Cap with External File Electrode	See section on how to replace file electrode.	
Foot Switch		
Guide Bar		
LS Oil		
Disposable Covers		
Eye Protector		

10. Troubleshooting

If the instrument does not seem to be working properly, the user should first try to inspect and adjust it himself.

* If the user is unable to inspect the instrument himself or if the instrument fails to work properly after being adjusted or after parts are replaced, contact your local dealer or the J.MORITA OFFICE.

Problem	Check Points	Response
No power.	Check battery installation.	Install battery properly.
	Check battery power.	Charge battery.
Cannot make a measurement	Check handpiece cord connection.	Plug handpiece cord securely.
	Does the file or reamer have an insulated shank?	Use a file or reamer that does not have insulation on its shank.
	Check handpiece cord for broken wire.	Touch the contrary electrode with file; if the meter does not react, there may be a broken wire in the handpiece cord.
Meter is not stable during use.	Does the built-in electrode need replacement? Has it been replaced recently?	<ul style="list-style-type: none"> • Clean and lubricate contra angle. • Take out the built-in electrode and clean it and the rotor axle with a brush. • Replace the built-in electrode.
No sound.	Check if sound is turned off.	Turn the sound on.
Cannot switch memories Cannot select a memory item Cannot change a memory value	Is a measurement being performed?	Switches do not work during measurement.
	Is the motor running?	Memory items cannot be selected or changed if the motor is running.
	Is light cure turned on?	Memory items cannot be selected or changed if the light is on.
	Is there a beep when the switch is pressed?	Switch may be defective.
Display does not appear.	Is there a sound when the unit is turned on and off?	Charge battery if there is no sound. Broken display if there is a sound.
Motor handpiece does not run.	Does the preparation display appear?	Check the handpiece cord connections.
	Is the foot switch depressed?	Step on the foot switch again. The motor runs when the foot switch is depressed and stops when it is released.
	Display is OK, but motor handpiece will not operate.	Try manual mode. If the motor handpiece operates in manual mode, the problem is with the unit's root canal measurement ability.
	Motor handpiece does not operate in manual mode and the overheat indicator [O.H.] appears in the display?	Motor handpiece is overheated.
	Is the battery power display down to a single bar? "Lo.b" appears in the speed display	Charge the battery It is nearly dead.
	None of the above	Motor handpiece or its cord may be defective.
Motor runs back and forth continuously	Is it set for OTR mode?	Torque load is greater than the setting for the OTR mode.
	Does it do this even after calibration?	Increase the torque setting by 1. * See page 16 for how to calibrate the instrument.
Motor handpiece will not go in reverse rotation.	See if it is set for apical stop, instead of apical reverse.	Set the unit for apical reverse: REVERSE.
	Check for combination of high torque reverse setting and slow motor speed due to auto torque slow down mode	<ul style="list-style-type: none"> • Turn off Auto Torque Slow Down • Change torque reverse setting
	Setting is OK but motor handpiece will not go in reverse.	Defective PC Board.

Problem	Check Points	Response
Motor handpiece changes speed on its own.	Is the unit set for Slow Down?	Change the Slow Down setting to Normal.
	Set for Auto Torque Slow Down?	Turn off Auto Torque Slow Down.
	Set for 800 rpm?	When set for 800 rpm, reverse speed is 600 rpm.
Motor handpiece does not stop.	Motor handpiece does not stop even if file is out of a root canal.	In manual mode, the file rotation does not stop even when the file is out of the root canal.
	Set for reverse rotation?	Press SET switch.
	Motor handpiece keeps running even when it's not in manual mode.	The motor handpiece will operate in reverse if the contrary electrode and file touch each other.
	Is foot switch depressed?	Release foot switch.
	File still keeps rotating.	Defective PC Board.
LED does not light up	Does light cure display appear?	Check handpiece and cord connections.
	Does display indicate overheating?	May not light up due to overheating.
	Not overheated	Light cure handpiece or its cord may be defective.
Turns off during irradiation	Is timer set?	Light turns off when set time elapses.
	Does display indicate overheating?	Light cure handpiece is overheated. It will recover its ability to run when it is cool enough.
	Low battery?	Light turns off if battery gets low. Charge battery.
Light does not turn off	Is light set for Manual.	Press the light switch of the foot switch.
"OH" is displayed and power cannot be turned off	Has motor been used for a long time or for a heavy load? Is motor hot?	If the motor overheats, the power will not go off until the motor cools off. The power will go off automatically once the motor cools off.

Error Codes

There may be something wrong with the instrument if any of the following error codes appear. If any of these appear repeatedly, contact your local dealer or the J.MORITA OFFICE for repairs.

Code*	Cause	Module	
		Measurement	Preparation and Light
F01	Defective canal measurement circuit	○	
F02	Defective off relay for the AC adapter		○
F03	Defective EEPROM	○	○
F04	Transmission Defect	○	○
F07	Defective Thermistor (Open / Short)		○*1
F08	LED broken lead		○*1

*1: Mainly a problem for the light cure handpiece

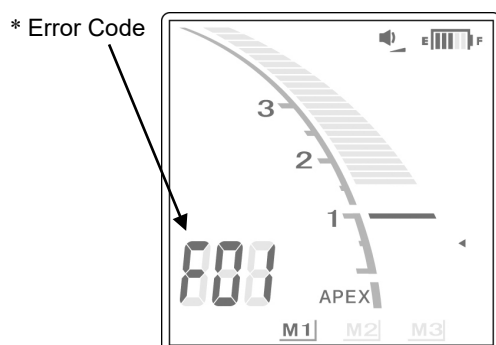

11. Technical Description

Main unit and accessories

Model DP-ZX

Type TR-EX

Classification:

Safety according to IEC 60601-1, IEC 60601-1-2, ANSI/AAMI ES60601-1, CAN/CSA C22.2 No.601.1-M90, European Directive 93/42/EEC IIa, and Canada Medical devices Class II

Degree of Protection against Electric Shock Type BF applied part

Degree of Protection against Ingress of Water IPX0

Mode of Operation Continuous

Intended use

1. It can be used to prepare root canals while monitoring the position of the file tip inside the root canal.
It can be used to measure the length of the root canal, and it can be used as low speed motorized handpiece.
2. Light Cure set can be used to polymerize (set) resinous and other materials by light from head.

Main unit

Rated Voltage	DC 9.6 V (with rechargeable battery operation)
Rated Current	max. 0.2 A (with rechargeable battery operation)
Power Consumption	1.92 VA (with rechargeable battery operation)
Rate Input Power	max. DC 17 V, 1.6 A (when AC adapter is connected and the rechargeable battery is charged)
Dimensions	Canal Preparation and Light Cure Module (when connected to Canal Measurement Module) 115 ± 20 (mm) × 105 ± 20 (mm) × 127 ± 20 (mm)
Weight	Canal Preparation and Light Cure Module (when connected to Canal Measurement Module) Approximately 710 g
Free running speed of the motor handpiece TR800 motor + DP-ZX contra angle	150 (±50) to 800 ± 200 rpm * Accuracy of the displayed values are ± 20% After a certain numbers of uses, this accuracy may not be achieved. The rotation speed will be slower than displayed values.
Rated Torque: TR800 motor + DP-ZX contra angle	min. 0.039 Nm

Handpiece

Motor Handpiece

Model	TR800
Rated Motor Input Voltage	max. DC 9.6 V
Rated Current	max. 0.2 A (with rechargeable battery operation)
Power Consumption	1.92 VA (with rechargeable battery operation)
Dimension	max. diameter 18 ± 3 (mm) \times length 165 ± 20 (mm)
Weight	Approximately 70 g
Motor	Miniature Direct Current Motor
Coupling Identification	DP-ZX coupling It can be used with only DP-ZX contra angle.
Mode of Operation	Intermittent
Field Repair	It can not be repaired in the field. Send to J. MORITA OFFICE or local dealer for repair.

DP-ZX Contra Angle

Model	DP-ZX contra angle
Free Running Maximum Operation Speed	800 rpm
Minimum Fitting Length of Shank	12.0 mm
Maximum Overall Length of Rotary Instrument	28.0 mm
Type of Shank	Type 1 (according to ISO 1797-1)
Type of Coupling	DP-ZX coupling * It can be used only with DP-ZX motor handpiece.
Gear Ratio	2.8 : 1
Chuck Type	Push Button Latch

Light Cure Handpiece

Light Intensity	1000mW/cm ²
Irradiation Time	10-sec. setting (10 ± 1 sec.) 20-sec. setting (20 ± 2 sec.) 40-sec. setting (40 ± 4 sec.)
Wave length	420 to 480 nm
Dimension	Head: diameter 15 ± 5 (mm), height 16 ± 5 (mm) Body: max. diameter 18 ± 3 (mm), length 165 ± 20 (mm)
Weight	Approximately 60 g





















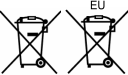



AC adapter

Model	GS25B17
Classification	Safety according to IEC 60950, UL 60950, C-UL Conforms with European directive 2004/108/EEC for Electromagnetic compatibility
Rated Input Voltage	AC 100 to 240 V
Rated Input Current	0.7 A
Rated Output Voltage	DC 15 V
Rated Output Current	1.2 A

Applied part

Handpiece Cord, Contrary Electrode (Canal Measurement Module Accessory)

Symbols

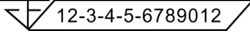
	Attention, consult accompanying documents.		Serial Number
	GS1 DataMatrix		Type BF applied part
	Manufacturer		Date of manufacture
	Unique device identifier		Medical device
	Direct current		Marking of electrical equipment in accordance with the European Directive 2012/19/EU (WEEE)
	Battery This symbol is affixed to fulfill the requirements of EU Directive 2006/66/EC Article 21. Batteries provided with this equipment cannot be disposed of as unsorted municipal waste within the European Union. Follow local regulations for disposal.		CE(0197) marking Conforms with the European Directive, 93/42/EEC. CE marking Conforms with the European Directive, 2011/65/EU.
	Autoclavable up to +135°C (+275°F)		Refer to instructions for use
	EU Authorized Representative under the European Directive 93/42/EEC		Keep away from rain
	This way up		Fragile
	Temperature limitation		Atmospheric pressure limitation
	Humidity limitation		Do not reuse
	Importer		Distributor
	Country or region (Country Names: Conforming to the ISO 3166-1 alpha-3 codes and EU for European Union) Description noted next to the code is an indication that conforms to the regulations valid only for the relevant country or region.		Registration number of medical device in Thailand (The 12-digit sample number shown is for demonstration purposes only.)

Contra Angle

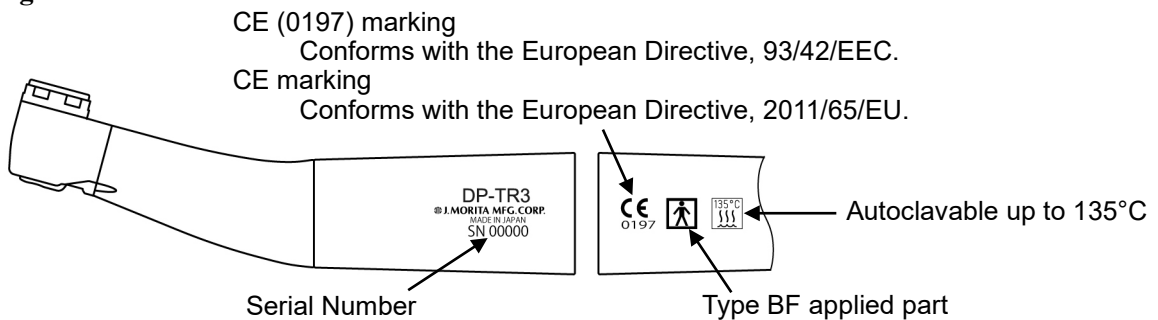

Motor Handpiece

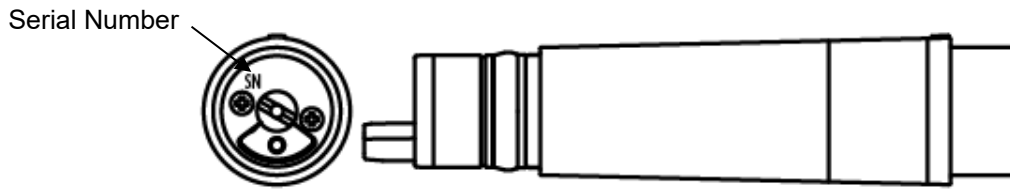

Light Cure Handpiece

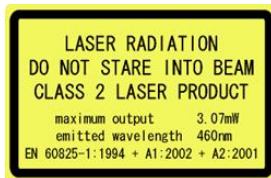
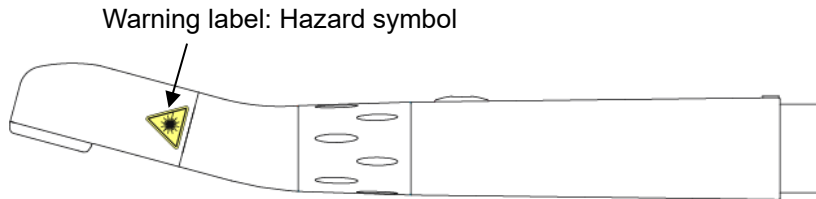

Explanatory Label

Canal Preparation and Light Cure Module

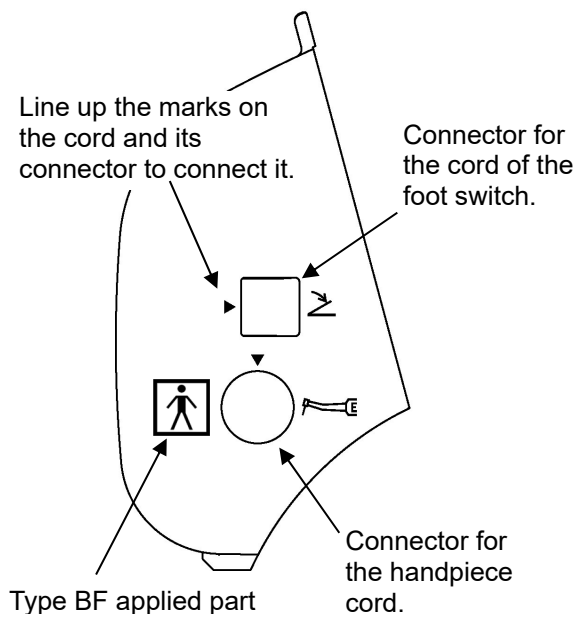

On the back side of the foot switch

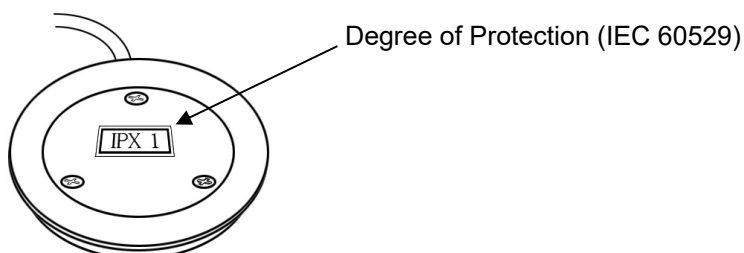

AC Adaptor

INPUT

Rated Input Voltage and Current

OUTPUT

Rated Output Voltage and Current



KCC Mark



CE Mark



C-UL US Listing Mark



Australia(C-Tick) Mark



BSMI Mark



CCC Mark



FCC Mark



GS Mark



Limited Power Source (for UL60950)



PSE Mark



WEEE Mark



Efficiency level V



Class II Equipment



Wiring Connection



Indoor use only

Operation, Transport and Storage Conditions for the main unit and AC adapter

Operating Conditions

Ambient temperature range	+10°C to +40°C (+50°F to +104°F)
Relative humidity	30% to 80 % without condensation
Atmospheric pressure range	80 kPa to 106 kPa

Transport and Storage Conditions

Ambient temperature range	-10°C to +70°C (-14°F to +158°F) (-10°C to +45°C (-14°F to +113°F) for battery)
Relative humidity	8% to 80%
Atmospheric pressure range	70 kPa to 106 kPa

Battery

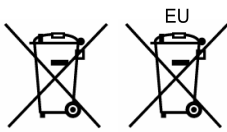

This symbol is affixed to fulfill the requirements of EU Directive 2006/66/EC Article 21. Batteries provided with this equipment cannot be disposed of as unsorted municipal waste within the European Union. Follow local regulations for disposal.

Disposal

The battery should be recycled*. Metal parts of the equipment are disposed as scrap metal. Synthetic materials, electrical components, and printed circuit boards are disposed as electrical scrap. Material must be disposed according to the relevant national legal regulations. Consult specialized disposal companies for this purpose. Please inquire of the local administration concerning local disposal companies.

* For disposal of batteries in EU countries, refer to the above remarks concerning batteries. Inquire with the local dealer where the batteries or equipment were purchased for details concerning battery disposal.

Service

DENTAPORT ZX may be repaired and serviced by

- the technicians of J. MORITA's subsidiaries all over the world.
- technicians employed by authorized J. MORITA dealers and specially trained by J. MORITA.
- independent technicians specially trained and authorized by J. MORITA.

Appendix- Electromagnetic declaration

Guidance and manufacturer's declaration – electromagnetic emissions		
The DP-ZX is intended for use in the electromagnetic environment specified below. The customer or the user of the DP-ZX should assure that it is used in such an environment.		
Emissions test	Compliance	Electromagnetic environment - guidance
RF emissions CISPR 11	Group 1	The DP-ZX uses RF energy only for its internal function. Therefore, its RF emissions are very low and are not likely to cause any interference in nearby electronic equipment.
RF emissions CISPR 11	Class B	The DP-ZX is suitable for use in all establishments, including domestic establishments and those directly connected to the public low-voltage power supply network that supplies buildings used for domestic purposes.
Harmonic emissions IEC61000-3-2	Class A	
Voltage fluctuations/flicker emissions IEC 61000-3-3	Complies	

Guidance and manufacturer's declaration – electromagnetic immunity			
The DP-ZX is intended for use in the electromagnetic environment specified below. The customer or the user of the DP-ZX should assure that it is used in such an environment.			
Immunity test	IEC 60601 test level	Compliance level	Electromagnetic environment - guidance
Electrostatic discharge (ESD) IEC 61000-4-2	±6 kV contact ±8 kV air	±2, 4, 6 kV contact ±2, 4, 8 kV air	Floors should be wood, concrete or ceramic tile. If floors are covered with synthetic material, the relative humidity should be at least 30 %.
Electrical fast transients/bursts IEC 61000-4-4	±2 kV for power supply lines ±1 kV for input/output lines	±2.0 kV for power supply lines ±1.0 kV for input/output lines	Mains power quality should be that of a typical commercial or hospital environment.
Surge IEC 61000-4-5	±1 kV line(s) to line(s) ±2 kV line(s) to earth	±0.5, 1 kV line(s) to line(s) ±0.5, 1, 2kV line(s) to earth	Mains power quality should be that of a typical commercial or hospital environment.
Voltage dips, short interruptions and voltage variations on power supply lines IEC 61000-4-11	<5% U_T (>95% dip in U_T) for 0.5 cycle 40% U_T (60% dip in U_T) for 5 cycles 70% U_T (30% dip in U_T) for 25 cycles <5% U_T (>95% dip in U_T) for 5 sec	0% U_T (>95% dip in U_T) /0.5 periods 40% U_T (60% dip in U_T) /5 periods 70% U_T (30% dip in U_T) /25 periods 0% U_T /5 sec.	Mains power quality should be that of a typical commercial or hospital environment. If user of the DP-ZX requires continued operation during power mains interruptions, it is recommended that the DP-ZX be powered from an uninterruptible power supply or a battery.
Power frequency (50/60 Hz) magnetic field IEC 61000-4-8	3 A/m	3.15 A/m	Power frequency magnetic field should be at levels characteristic of a typical location in a typical commercial or hospital environment.
Note U_T is the a.c. mains voltage prior to application of the test level.			

Guidance and manufacturer's declaration – electromagnetic immunity			
The DP-ZX is intended for use in the electromagnetic environment specified below. The customer or the user of the DP-ZX should assure that it is used in such an environment.			
Immunity test	IEC 60601 test level	Compliance level	Electromagnetic environment - guidance
Conducted RF IEC 61000-4-6	3 Vrms 150 kHz to 80 MHz	3.15 V	Portable and mobile RF communications equipment should be used no closer to any part of the DP-ZX , including cables, than the recommended separation distance calculated from the equation applicable to the frequency of the transmitter. Recommended separation distance $d = 1.11 \sqrt{P}$ $d = 0.95 \sqrt{P}$ 80 MHz to 800MHz $d = 1.89 \sqrt{P}$ 800MHz to 2.5 GHz Where P is the maximum output power rating of the transmitter in watts (W) according to the transmitter manufacturer and d is the recommended separation distance in meters (m). Field strengths from fixed RF transmitters, as determined by an electromagnetic site survey, ^a should be less than the compliance level in each frequency range. ^b Interference may occur in the vicinity of equipment marked with the following symbol: 
Radiated RF IEC 61000-4-3	3 V/m 80 MHz to 2.5 GHz	3.7 V/m	
NOTE 1: At 80 MHz and 800 MHz, the higher frequency range applies. NOTE 2: These guidelines may not apply in all situations. Electromagnetic propagation is affected by absorption and reflection from structures, objects and people. ^a Field strengths from fixed transmitters, such as base stations for radio (cellular/cordless) telephones and land mobile radios, amateur radio, AM and FM radio broadcast and TV broadcast cannot be predicted theoretically with accuracy. To assess the electromagnetic environment due to fixed RF transmitters, an electromagnetic site survey should be considered. If the measured field strength in the location in which the DP-ZX is used exceeds the applicable RF compliance level above, the DP-ZX should be observed to verify normal operation. If abnormal performance is observed, additional measures may be necessary, such as reorienting or relocating the DP-ZX . ^b Over the frequency range 150 kHz to 80MHz, field strengths should be less than 3 V/m.			

Recommended separation distances between portable and mobile RF communications equipment and the DP-ZX.

The DP-ZX is intended for use in an electromagnetic environment in which radiated RF disturbances are controlled. The customer or the user of the DP-ZX can help prevent electromagnetic interference by maintaining a minimum distance between portable and mobile RF communications equipment (transmitters) and the DP-ZX as recommended below, according to the maximum output power of the communications equipment.

Rated maximum output power of transmitter W	Separation distance according to frequency of transmitter m		
	150 kHz to 80 MHz $d = 1.2\sqrt{P}$	80 MHz to 800 MHz $d = 1.2\sqrt{P}$	800 MHz to 2.5 GHz $d = 2.3\sqrt{P}$
0.01	0.11	0.09	0.19
0.1	0.35	0.30	0.60
1	1.11	0.95	1.89
10	3.51	2.99	5.98
100	11.11	9.46	18.92

For transmitters rated at a maximum output power not listed above, the recommended separation distance d in meters (m) can be estimated using the equation applicable to the frequency of the transmitter, where P is the maximum output power rating of the transmitter in watts (W) according to the transmitter manufacturer.

NOTE 1: At 80 MHz and 800 MHz, the separation distance for the higher frequency range applies.

NOTE 2: These guidelines may not apply in all situations. Electromagnetic propagation is affected by absorption and reflection from structures, objects and people.

Essential Performance



Noise does not substantially change measurement.

Noise will not change operation mode.

Noise will not permanently alter display values.

Noise will not cause the instrument to operate in any way other than intended.

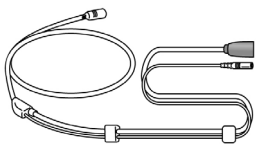
Accessories

Handpiece Cord	Foot Switch (Sold separately)
Code No. 7503960 	Code No. 7503985 

⚠ WARNING

- *Use of the parts other than those accompanied or specified by J. MORITA MGF. CORP. may result in increased EMC emissions or decreased EMC immunity of the DENTAPORT ZX.*

Development and Manufacturing



J. MORITA MFG. CORP.

680 Higashihama Minami-cho, Fushimi-ku, Kyoto 612-8533, Japan
T +81. (0)75. 611 2141, F +81. (0)75. 622 4595

Morita Global Website www.morita.com

Distribution

J. MORITA CORP.

3-33-18 Tarumi-cho, Suita-shi, Osaka 564-8650, Japan
T +81. (0)6. 6380 1521, F +81. (0)6. 6380 0585

J. MORITA USA, INC.

9 Mason, Irvine CA 92618, USA
T +1. 949. 581 9600, F +1. 949. 581 8811

J. MORITA EUROPE GMBH

Justus-von-Liebig-Strasse 27b, 63128 Dietzenbach, Germany
T +49. (0)6074. 836 0, F +49. (0)6074. 836 299

MORITA DENTAL ASIA PTE. LTD.

150 Kampong Ampat #06-01A KA Centre, Singapore 368324
T +65. 6779. 4795, F +65. 6777. 2279

J. MORITA CORP. AUSTRALIA & NEW ZEALAND

Suite 2.05, 247 Coward Street, Mascot NSW 2020, Australia
T +61. (0)2. 9667 3555, F +61. (0)2. 9667 3577

J. MORITA CORP. MIDDLE EAST

4 Tag Al Roasaa, Apartment 902, Saba Pacha 21311 Alexandria, Egypt
T +20. (0)3. 58 222 94, F +20. (0)3. 58 222 96

J. MORITA CORP. INDIA

Filix Office No.908, L.B.S. Marg, Opp. Asian Paints, Bhandup (West), Mumbai 400078, India
T +91-82-8666-7482

J. MORITA MFG. CORP. INDONESIA

28F, DBS Bank Tower, Jl. Prof. Dr. Satrio Kav. 3-5, Jakarta 12940, Indonesia
T +62-21-2988-8332, F + 62-21-2988-8201

SIAMDENT CO., LTD.

71/10 Moo 5 T. Tharkham A. Bangpakong Chachuengsao 24130 Thailand
T +66 (0) 3857 3042, F +66 (0) 3857 3043 www.siamdent.com