



Root ZX3

INSTRUCTIONS FOR USE

Apex Locator Module



Thank you for purchasing the Root ZX3.

For optimum safety and performance as well as to avoid causing harm to people, read this manual thoroughly before using the device and pay close attention to warnings and cautions. Keep this manual in a readily accessible place for quick and easy reference.

* The device is the apex locator module dedicated to the Root ZX3.

This device can add a HF module (sold separately) for high-frequency conduction treatment in addition to the apex location function.



Instructions for Use in Electronic Format (eIFU)

The electronic data (PDF document) of the Instructions for Use is available. Scan the following QR code and visit our website.



In order to view PDF documents, you will need the free Adobe Acrobat Reader distributed by Adobe Inc. Download the latest version via the Adobe website. PDF documents may not be displayed correctly using previous versions.

Trademarks and Registered Trademarks:

Parts of the names of companies, products, services, etc. used in this manual may contain either trademarks or registered trademarks owned by each company.

Table of Contents

1 Introduction	6
1.1 Customers	6
1.2 Dealers	6
1.3 Preventing Accidents	6
1.4 In Case of Accident	7
2 Precautions	8
3 Intended Use	9
3.1 Intended Purpose	9
3.2 Indications for Use	9
3.3 User Qualifications (Intended Operator Profile)	9
3.4 Patient Population	9
3.5 Intended Environment	10
3.6 Contraindications, Warnings, and Considerations	10
3.7 Supposed Useful Life	10
4 Parts Identification and Display Screens	11
4.1 Parts Identification	11
4.2 LCD Display and Switches	13
5 Usage	14
5.1 Set Up	14
5.1.1 Install the Dry Batteries.	14
5.1.2 Probe Cord Connection	16
5.1.3 Operation Check	17
5.2 Usage	18
5.2.1 Apex Location	18
5.2.1.1 LCD Display and Speaker Sound during Apex Location	21
5.2.2 Apex Location Accuracy Manual Check	23
5.2.3 Root Canals Not Suitable for Electric Apex Location	24
5.3 After Use	26
5.4 Reprocessing	27
5.4.1 Parts to be Sterilized	28
5.4.2 Parts to be Disinfected	31

6 How to Modify Various Settings	33
6.1 Memory Contents	33
6.1.1 Editable Items and Default Settings	33
6.1.2 Procedures	34
6.2 Other Functions.....	36
6.2.1 Editable Items and Default Settings	36
6.2.2 Procedures	36
6.3 Resetting the Default Settings.....	38
7 Troubleshooting	39
7.1 Troubleshooting.....	39
7.2 Error Numbers.....	41
8 Replacement Parts	42
8.1 Parts Replacement.....	42
9 Electromagnetic Disturbances (EMD)	43
10 Technical Specifications	46
10.1 Specifications	46
10.2 Symbols	47
11 Regular Inspection	48
11.1 Regular Inspection.....	48
11.1.1 Regular Inspection Items	48
12 Service and Disposal	49
12.1 Service	49
12.2 Standards and Procedures for Disposal of Medical Devices	49

1 Introduction

1.1 Customers

Make sure to obtain clear instructions concerning the various ways to use this device described in this accompanying manual. To access the warranty information for this product, scan the following QR code and visit our website.



1.2 Dealers

Be sure to give clear instructions concerning the various ways to use this device as described in this accompanying manual.

1.3 Preventing Accidents

Most operation and reprocessing problems result from insufficient attention to basic safety precautions and not being able to foresee potential accidents. Problems and accidents are best avoided by foreseeing the possibility of danger and operating the unit in accordance with the manufacturer's recommendations.

First, thoroughly read all precautions and instructions pertaining to safety and accident prevention. Then operate the device with the utmost caution to prevent either damaging the device itself or causing bodily injury.

Do not use the Root ZX3 for purposes other than its specified intended use in dental treatment.

The following symbols and expressions indicate the degree of danger and harm that could result from ignoring the corresponding instructions:

PROHIBITION

This indicates contraindications, related descriptions with operation and usage, as well as patients to whom this should not be applied due to their symptoms, underlying conditions, complications, anamnestic history, family history, or diathesis.

WARNING

This alerts the user of the possibility of extremely serious injury or complete destruction of the device, as well as other property damage including the possibility of fire.

CAUTION

This alerts the user of the possibility of minor or moderate injury or damage to the device.



This informs the user of important points concerning operation or the risk of device damage.

The user (e.g., healthcare facility, clinic, hospital, etc.) is responsible for the management maintenance and use of medical devices.

This device must not be used by anyone other than dentists, doctors, or other legally licensed professionals.

1.4 In Case of Accident

If an accident occurs, this device must not be used until repairs have been completed by a qualified and trained technician authorized by the manufacturer.

For customers who use the Root ZX3 in the EU and Saudi Arabia:

If any serious incident occurs in relation to the device, report it to a competent authority of your country, as well as the manufacturer through your regional distributor. Observe relevant national regulations for detailed procedures.

2 Precautions

PROHIBITION

- Do not use this device on patient who has implanted a pacemaker or ICD (Implantable Cardiac Defibrillator). (May cause pacemakers and ICDs to malfunction.)
- Do not use this device simultaneously with any other electrosurgical unit (hereafter “high-frequency conduction treatment device”). Otherwise, it may result in burns due to high-frequency current leakage, or malfunction by mutual interference.

WARNING

- No modification of this device is allowed.
- Do not add in or connect this device to any other devices or systems except products designated by J. MORITA MFG. CORP.
- Do not use the wireless transmission devices listed below in the patient examination area. Electromagnetic interference from such devices could cause the Root ZX3 to malfunction.
 - (1) Mobile phones and smart devices
 - (2) Wireless transmitting devices such as ham radios, walkie-talkies, and transceivers
 - (3) Personal Handy-phone System (PHS)
 - (4) Routers for intra-building paging systems, wireless LANs, analog cordless telephones, and other electric wireless devices
- Electromagnetic emissions produced by electric scalpels, lighting equipment, or other devices being used nearby could adversely affect the Root ZX3 operation.
- Do not perform maintenance while using this device for treatment.
- Always wear personal protective equipment (PPE) such as safety glasses, gloves, a mask, etc. when using and reprocessing this device.

3 Intended Use

3.1 Intended Purpose

Locate the apex inside the canal.

3.2 Indications for Use

The Root ZX3 device is a dental device with an apex locating function and an optional electrosurgical function and is composed of the aforementioned corresponding modules.

The apex locating function of Root ZX3 device is used for root canal measurement and working length determination.

3.3 User Qualifications (Intended Operator Profile)

a) Qualification:

Legally qualified person such as dentists for endodontic device operation (it may differ among countries).

b) Education and Knowledge:

Have a good understanding of risks associated with root canal treatment.

It is also assumed the user is thoroughly familiar with root canal treatment including the prevention of cross-infection.

c) Language Understanding:

English and local language (Intended for professional use as described above.)

d) Experience:

Person with experience operating endodontic devices.

No special training is required except in cases where this is required by legal regulations of the relevant country or region.

3.4 Patient Population

 **CAUTION**

- This device is not recommended for use in children under 12 years of age.
- Pay close attention to the patient during treatment with this device.

Age : Child (12 or older) to Elderly

Weight : Not applicable

Nationality : Not applicable

Sex : Not applicable

Condition : Conscious and mentally alert person. (Person who can stay still during treatment.)

3.5 Intended Environment

This device is used in general dental clinics and hospitals (= Professional healthcare facility environment), and the following environment is assumed:

- Non-sterile environment
- Normal room lighting
- Low-noise environment in which the sound emitted by this device is audible

Operating Environments

Temperature : +10°C to +35°C (+50°F to +95°F)

Humidity : 30% to 80% (without condensation)

Atmospheric Pressure : 70 kPa to 106 kPa

Transport and Storage Environments

Temperature : -10°C to +45°C (+14°F to +113°F)

Humidity : 10% to 85% (without condensation)

Atmospheric Pressure : 70 kPa to 106 kPa

- ! Do not expose the device to direct sunlight for an extended period of time.
- ! If the device has not been used for some time, make sure it works properly before using it again.
- ! Always remove the dry batteries prior to storing or shipping the device.

3.6 Contraindications, Warnings, and Considerations

- Do not use this device on patient who has implanted a pacemaker, ICD (Implantable Cardiac Defibrillator), or cochlear implant.

3.7 Supposed Useful Life

The useful life of the Root ZX3 is 6 years from the date of installation provided it is regularly and properly inspected and maintained.

4 Parts Identification and Display Screens

4.1 Parts Identification

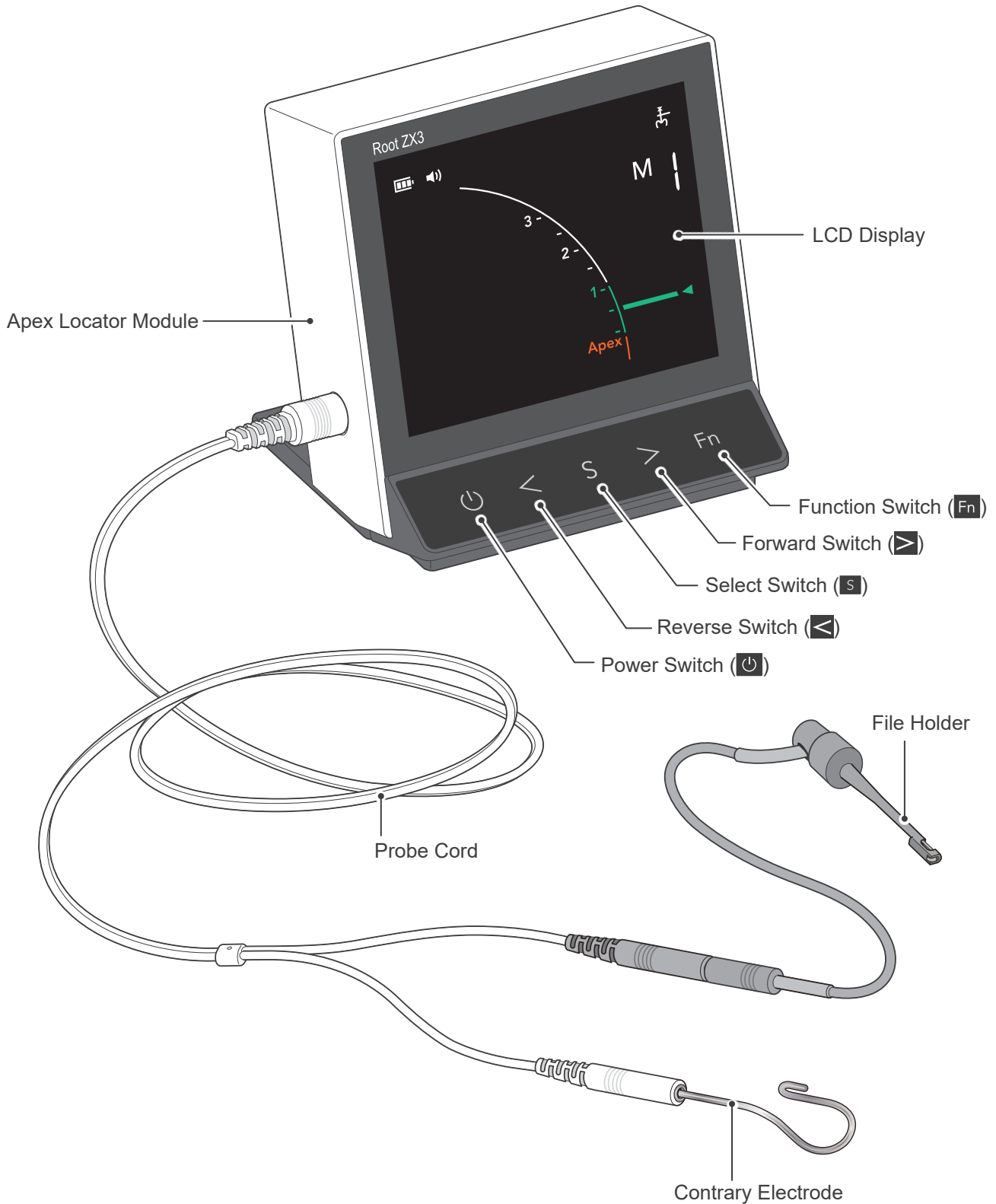

■ Components

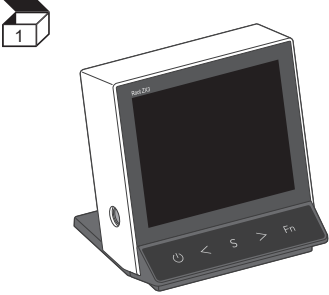
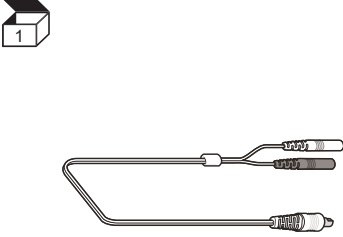
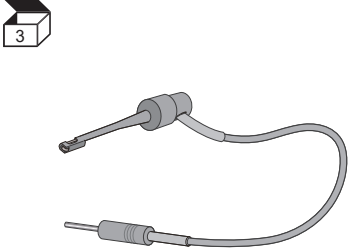
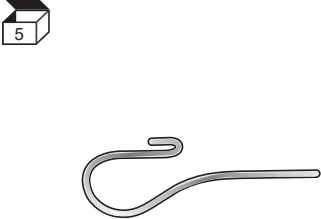
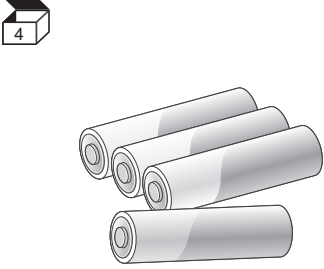
Apex Locator Module	Probe Cord	File Holders
 <p>1</p>	 <p>1</p>	 <p>3</p>
Contrary Electrodes	Alkaline Dry Batteries (AA size)	
 <p>5</p>	 <p>4</p>	

■ Optional Items (sold separately)

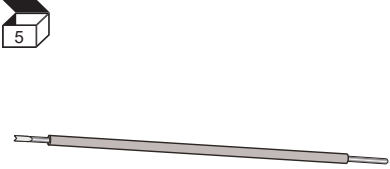
Long File Holders
 <p>5</p>

4.2 LCD Display and Switches

LCD Display

Battery Power
The number of bars show how much power is left.
! When only one bar is displayed, replace all the dry batteries with new ones. p. 14

Speaker Volume
You can adjust the speaker volume.

Apex Location Indicator Bars
Indicates the location of the file tip.

Mode Icon
Displays when the device is in apex location mode.

Memory Number (M1, M2, M3)
For details of each memory setting;
 p. 33

0.5 Meter Reading
 p. 20

Flash Bar (FB)
Use this as an estimate position for apex location. This can be set between meter gauge 2 and the Apex.
* E.g., Flash bar 32 (FB. 32) indicates the position of the apex location indicator bar at 32nd from the top (meter gauge 0.5).

Meter Gauge
The numerals 1, 2, and 3 do not represent length in millimeters from the apex. Use these numbers as an estimate only.

Message Indicator

- During Apex Location Number of bars left before the flash bar is reached.
- While Changing the Settings Setting value is displayed.
- When an Error Occurs Error number is displayed. p. 41

Switches

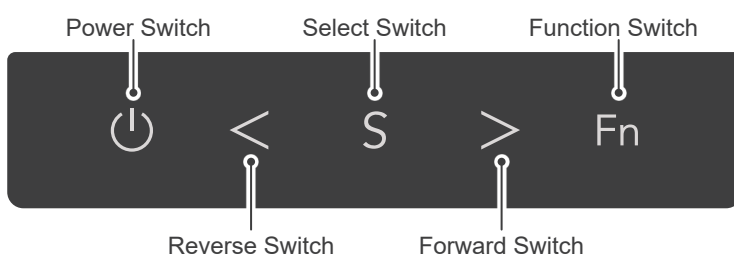

5 Usage

5.1 Set Up

- ! Be sure to perform reprocessing on the respective parts before using them for the first time.
☞ p. 27 “5.4 Reprocessing”

Check the followings before using the Root ZX3.

- Have the autoclavable parts been autoclaved?
For details of autoclavable parts; ☞ p. 28 “5.4.1 Parts to be Sterilized”
- Have the disinfectable parts been disinfected?
For details of disinfectable parts; ☞ p. 31 “5.4.2 Parts to be Disinfected”
- Does the battery power indicator show sufficient remaining power?

5.1.1 Install the Dry Batteries.

⚠ CAUTION

- Do not leave the power on when installing or replacing dry batteries.
- Always observe the following points. Otherwise, dry battery may generate abnormal heat.
- When the battery power indicator displays only one bar, replace all the dry batteries with new ones.
- Use alkaline dry batteries (AA size). Zinc-carbon batteries and nickel-metal hydride batteries can be used, but the device available time will be shortened compared to the alkaline dry batteries. Do not use any other type of batteries.
- When replacing dry batteries, change all four batteries with new ones of the same manufacture and model.
- When replacing dry batteries, make sure that the polarity direction (positive/negative) is correct.
- Do not use any defective (i.e., leaky, deformed, discolored, etc.) dry batteries.
- If a battery leaks, wipe the liquid thoroughly from the dry battery housing and replace all the dry batteries with new ones.

- ! Dispose of the used dry batteries in accordance with the regulation of your local government.
- ! Do not drop the Root ZX3 or give a strong impact on it. These could result in malfunction or damage to the device.

- * Dry batteries are removed from the device prior to shipment.
Install accompanied four alkaline dry batteries (AA size).
- * Normal device available time with four alkaline dry batteries (AA size) is approximately six months.
However, higher LCD brightness settings may drain battery power faster.

When dry batteries run out, a beep sounds, the message “LOW BATTERY” displays, and the device will turn off automatically.

Replace all the dry batteries with new ones immediately.

Battery Power Indication

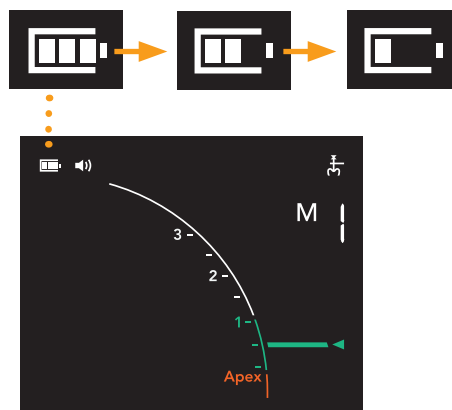

1 Remove the Dry Battery Housing.

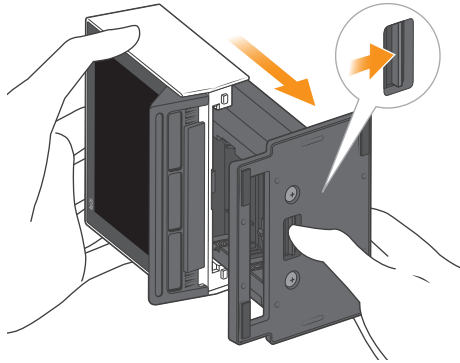

2 Install the Dry Batteries.

! Do not reverse the polarity direction (positive/negative).

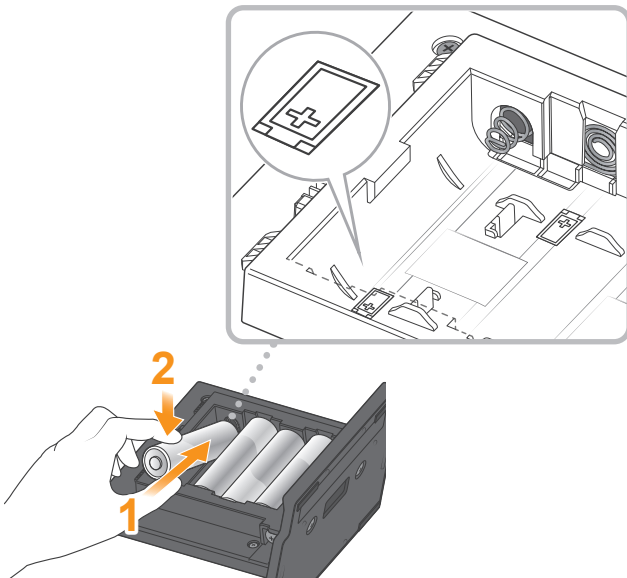

3 Reinstall the Dry Battery Housing.

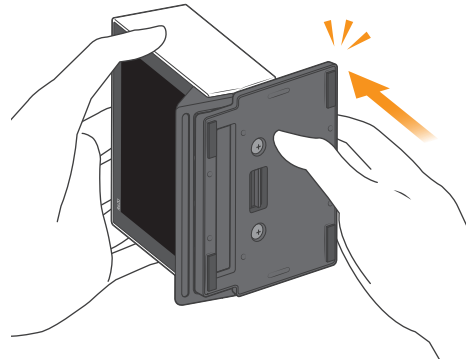

5.1.2 Probe Cord Connection

1 Connect the probe cord to the device.

⚠ CAUTION

- Make sure that the plug is inserted all the way. If the plug is improperly connected, the device may not work correctly.

- ❗ Avoid strong impacts to the connection.
- ❗ Do not wind the probe cord around the device.

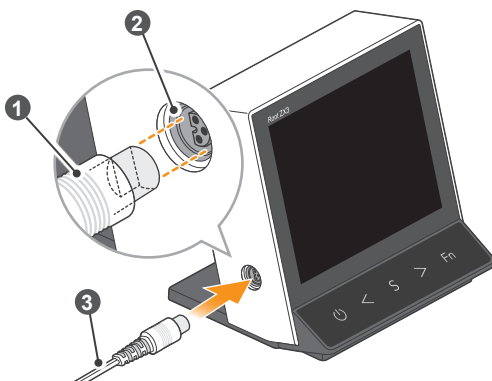

- ❶ Plug
- ❷ Connection Port
- ❸ Probe Cord

2 Connect the file holder and contrary electrode.

⚠ CAUTION

- Connect the file holder and contrary electrode onto the probe connectors correctly. Accurate apex location cannot be obtained if there are reversed.

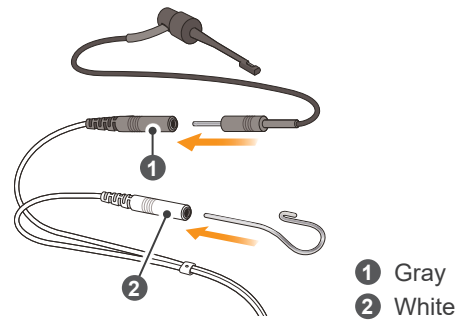

Correct

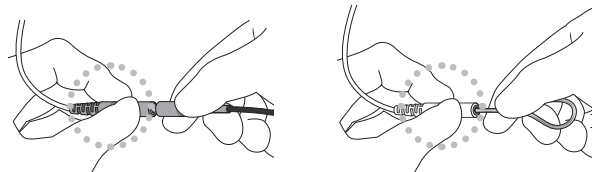

Incorrect

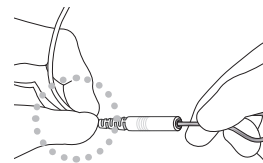

5.1.3 Operation Check

⚠ CAUTION
• Check the Root ZX3's functionality before use with each patient.

1 Check the connections.

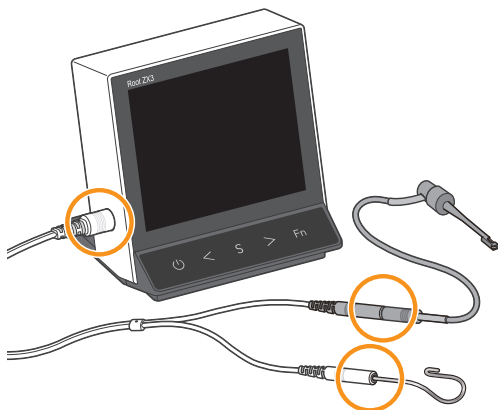

2 Turn on the device.

! When only one bar () is displayed, replace all the dry batteries with new ones.

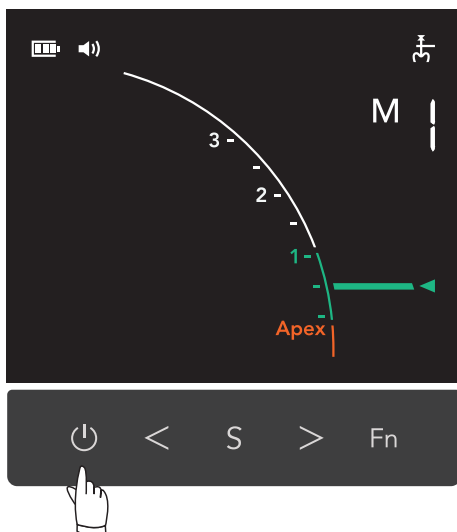

3 Touch the contrary electrode with the file holder contact.

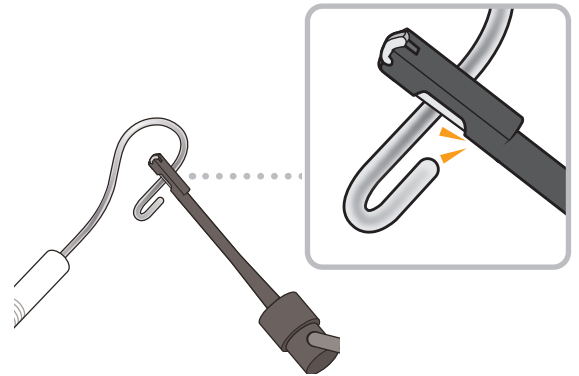

4 Check the LCD display.

⚠ CAUTION
• If all the apex location indicator bars do not light up, accurate canal location cannot be obtained. Stop using the device immediately and have it professionally repaired.

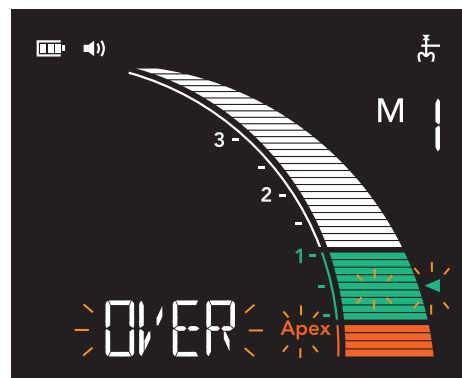

Confirm the following points:

- All the apex location indicator bars are lit up.
- "Over", "Apex", and "◀" blink.
- A continuous beep sounds.

5.2 Usage

* Example of operation with setting the flashing bar at 0.5 meter reading.

5.2.1 Apex Location

⚠ CAUTION

- Do not use the Root ZX3 together in conjunction with an ultrasonic scaler. Otherwise, the apex location might not be accurate.

- ! While using the device, if the LCD display is unstable or the device turns off on its own (except the auto power off function), stop using the device immediately and have it professionally repaired.

1 Turn on the device.

👉 p. 17 “2 Turn on the device.”

2 Select a memory number.

⚠ CAUTION

- Always check the settings of the selected memory before use.

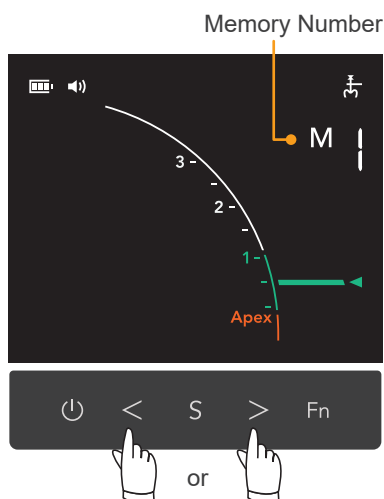

* For more details on memory settings:

👉 p. 33 “How to Modify Various Settings”

3 Hook the contrary electrode.

⚠ WARNING

- Never place the contrary electrode, file holder, or other connection parts in contact with a power source (e.g., power outlet). You could get an electric shock.

⚠ CAUTION

- The contrary electrode could cause an adverse reaction if the patient has an allergy to metals. Ask the patient about this before using the contrary electrode.
- Take care that medicinal solutions such as formalin cresol or sodium hypochlorite do not get on the contrary electrode or the file holder. These could cause inflammation of tissues.
- If connections are not securely plugged in the device, it may not accurately locate the apex. If the meter does not change as the file goes down the canal, stop using the device immediately and make sure all the connections are securely inserted.

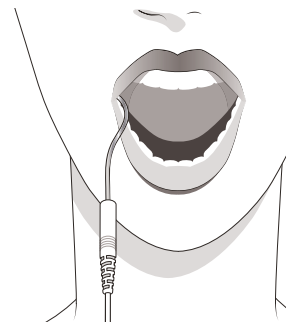

* Make sure that the contrary electrode touches patient's oral mucosa.

4 Clip the file.

⚠ WARNING

- Do not use worn or bent files or reamers.
- Make sure that the file or reamer is properly clipped. If it is loose, the file or reamer could come off and injure the patient.
- Always use a rubber dam to prevent accidental swallowing of files, reamers, etc.

⚠ CAUTION

- Files and reamers are sharp; handle with care.
- Use a file or reamer with a plastic handle and be sure not to touch its metal part. If you do not wear gloves, electricity flows through the metal part to your fingers and accurate apex location cannot be obtained.
- Do not use damaged file holders. Otherwise, accurate apex location cannot be obtained.

- ❗ Clip the file holder onto the metal upper part of the file or reamer (close to the handle). Do not clip it onto the cutting part or transition part of the file or reamer. This will cause the file holder contact and plastic to wear out very quickly.

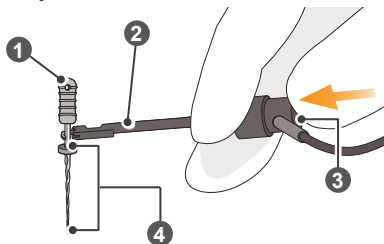

- ① Handle ② File Holder
③ Push Button ④ Cutting and Transition Parts

⚠ CAUTION

- Do not clip a file or reamer as shown in figure 2. Otherwise, an accurate apex location cannot be obtained and the tip of the file holder will be damaged.

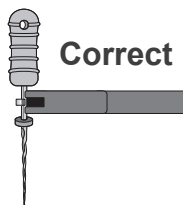

Figure 1

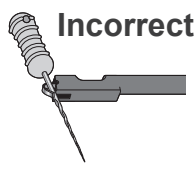

Figure 2

5 Perform apex location.

⚠ WARNING

- Stop using the device immediately if it does not seem to be working properly.
- Since files and reamers can easily break due to metal fatigue and excessive load, do not use excessive force to insert them. It may result in digging into the canal and breaking the file or reamer.

⚠ CAUTION

- Accurate apex location may not always be possible, it depends on tooth condition, case complexity, as well as degradation of the device. Make sure to take an X-ray to check the results.
 - ☞ p. 24 “5.2.3 Root Canals Not Suitable for Electric Apex Location”
- If none of the apex location indicator bars appear even when the file is inserted, the device may be malfunctioning. Stop using the device immediately and contact your local dealer or J. MORITA OFFICE.
- Do not touch the gums with the file. Otherwise, an accurate apex location cannot be obtained.
- If the canal is too dry, the meter may not move until the file is near the apex. If the meter does not move, stop the operation. Moisten the canal with oxydol (hydrogen peroxide) or saline, and then try to perform apex location again.
- After apex location, make sure to take an X-ray to check the results.

- * The meter may make a sudden and large movement as soon as the file is inserted into the root canal, but it will return to normal as the file is advanced down towards the apex.

- * When the probe cord or connector is disconnected, the apex location will stop working.

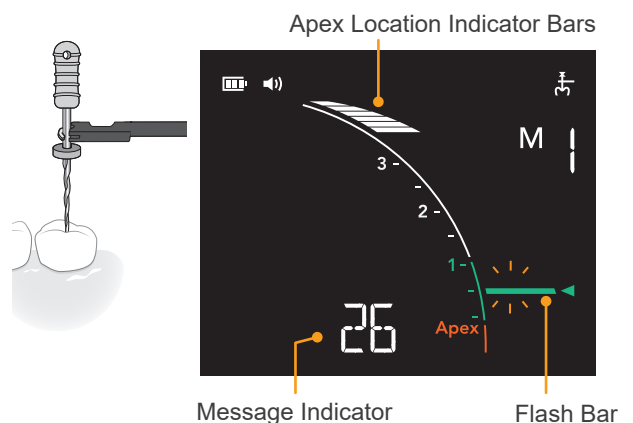

The message indicator shows how many apex location indicator bars there are until the flash bar.

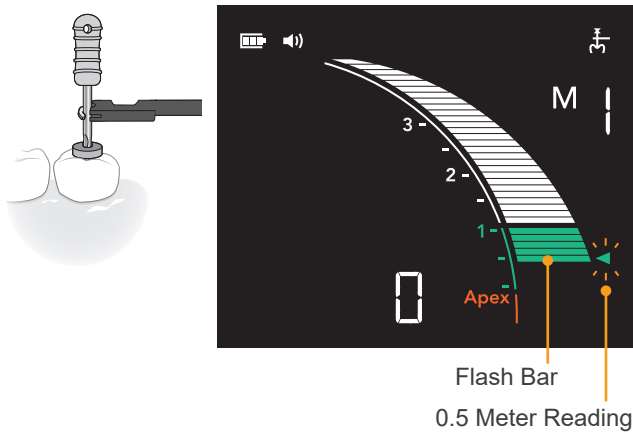

Advance the file down the canal to the 0.5 meter reading point (◀). Then position a rubber stopper on the surface of the tooth or other suitable point to serve as a reference.

● 0.5 Meter Reading

The meter's 0.5 reading indicates that the file tip is located very near the physiological apical foramen. Use this position as a reference to determine the working length depending on the individual case. The exact working length depends on the shape and condition of the canal, and a clinical judgment must be made by the dentist.

The numerals 1, 2, and 3 do not represent length in millimeters from the apex. These numbers are used as a reference to determine the working length.

When the apex location indicator bars exceeds the flash bar, the message indicator displays "OVER" with a blink. Also, the flash bar and "◀" (0.5 meter reading) blink and continuous beep sounds.

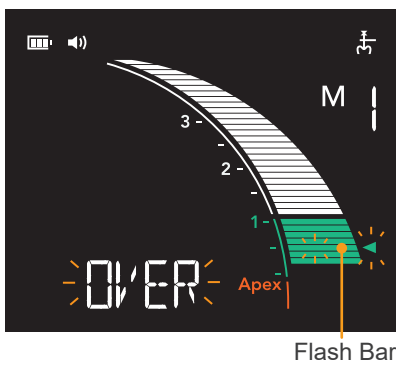

6 Turn off the device.

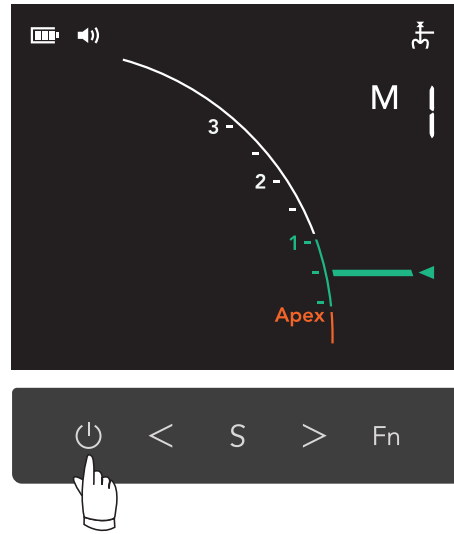

● Auto Power Off

If switches are not used for 10 minutes (default setting), the device will automatically turn off.

p. 37 "Auto Power Off Time"

5.2.1.1 LCD Display and Speaker Sound during Apex Location

The location of the file tip inside the canal is shown by the apex location indicator bars. The speaker sound will change according to the position of the apex location indicator bars.

This section describes the changes when the flash bar is set to FB.30 (the 30th apex location indicator bar from the top).

- The apex location indicator bar in range between 0 and 19th. (Until one bar before the meter reading 2.)

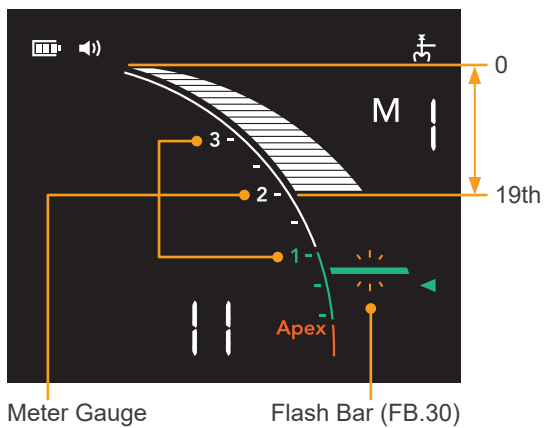

No sound.
The flash bar blinks.

- The apex location indicator bar in range between 28th and the bar one before the flash bar.

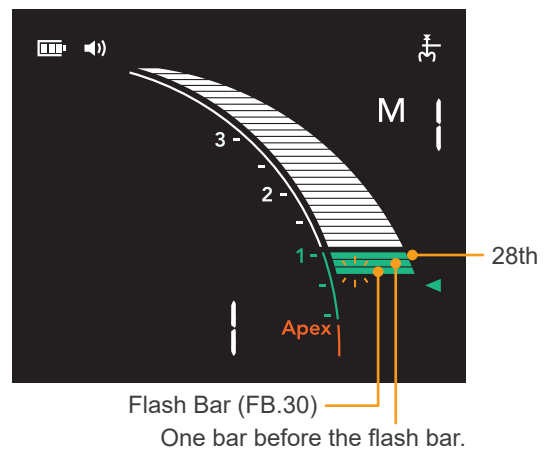

A fast tempo tone sounds.
The flash bar blinks.

- The apex location indicator bar in range between 20th and 27th. (From meter reading 2 until one bar before the meter reading 1.)

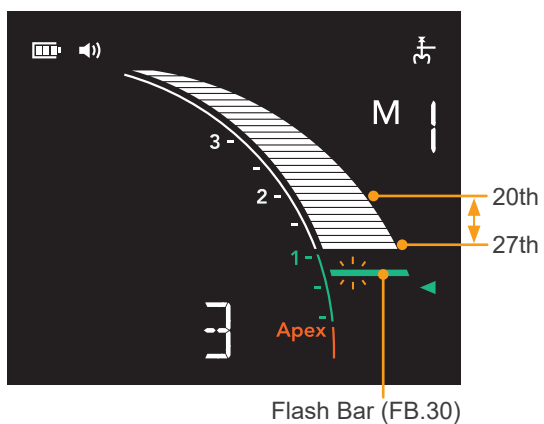

A slow tempo tone sounds.
The flash bar blinks.

- The apex location indicator bars reach the flash bar.

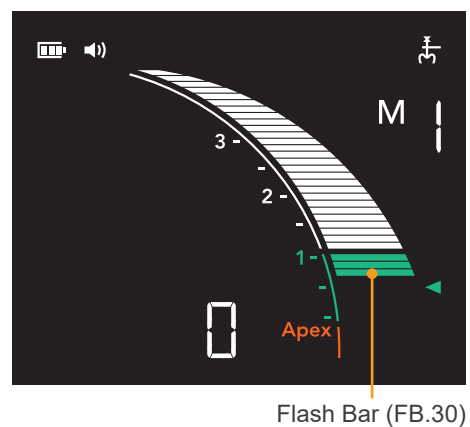

A continuous tone sounds.
The flash bar stays on.

- The apex location indicator bars exceed the flash bar.

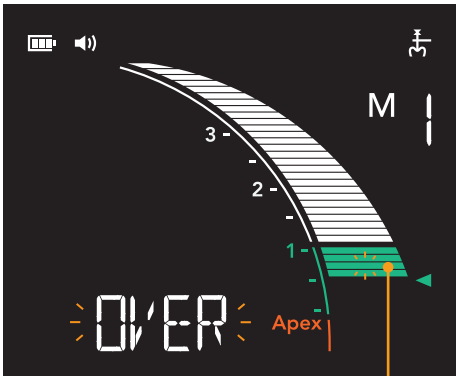

Flash Bar (FB.30)

A continuous tone sounds.
"OVER" and the flash bar blink.

- The apex location indicator bars reach the Apex position.

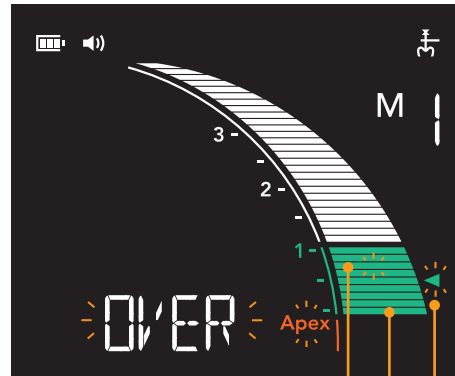

Flash Bar (FB.30)
Apex Position
0.5 Meter Reading

A continuous tone sounds.
"OVER", "Apex", the flash bar, and "◀" (0.5 meter reading) blink.

* Even if the apex location indicator bars exceed the Apex, a continuous tone sounds and "OVER", "Apex", the flash bar, and "◀" (0.5 meter reading) blink.

- The apex location indicator bars reach the 0.5 meter reading.

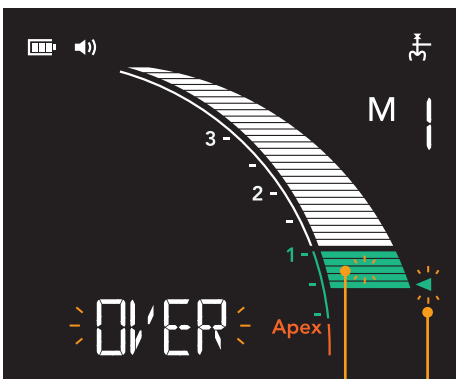

Flash Bar (FB.30)
0.5 Meter Reading

A continuous tone sounds.
"OVER", the flash bar, and "◀" (0.5 meter reading) blink.

5.2.2 Apex Location Accuracy Manual Check

1 Press the function switch.

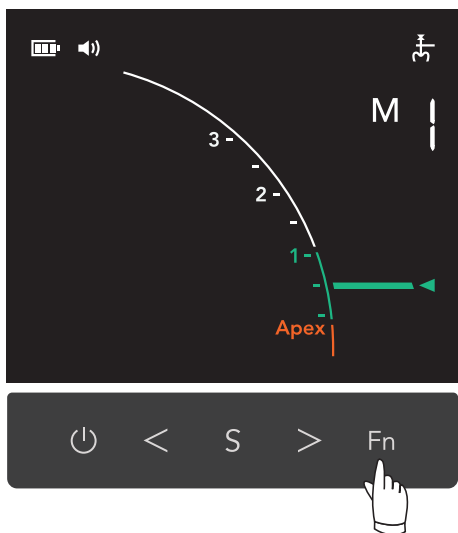

Hold Down
(1 second or more)

2 Accuracy check starts.

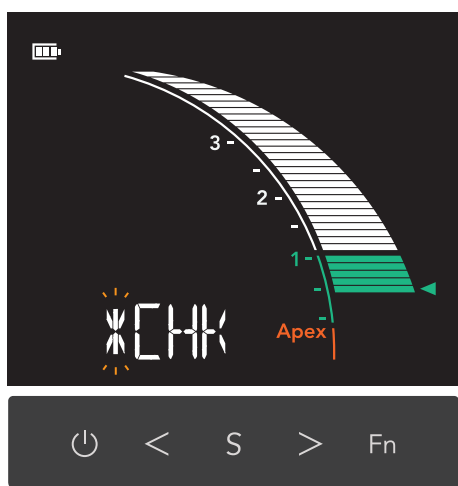

3 The result message is displayed.

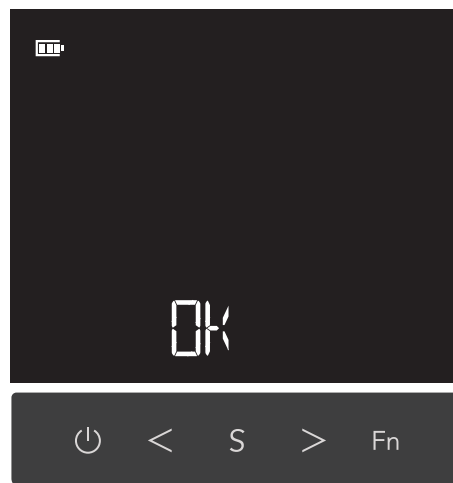

If the accuracy of the apex location is within the criteria, "OK" will be displayed. Then the display returns to the apex location screen automatically.

If "ERR.0" is displayed, the apex location was not accurately confirmed. Stop using the device immediately and contact your local dealer or J. MORITA OFFICE.

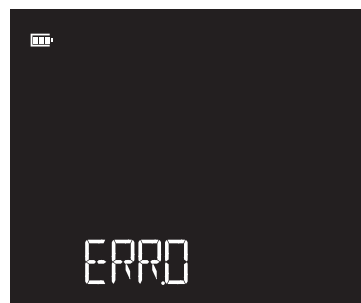

5.2.3 Root Canals Not Suitable for Electric Apex Location

■ Root Canals not suitable for Root ZX3.

Accurate apex location cannot be obtained with the root canal conditions shown below.



Root canal with a large apical foramen

Tooth with incomplete root canal (e.g., root resorbed tooth and primary tooth).

Root canal with blood overflowing from the opening

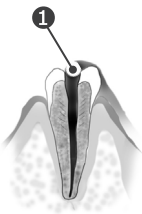

If blood overflows from the opening of the root canal and contacts the gums, this will result in electrical leakage and an accurate apex location cannot be obtained. Wait for bleeding to stop completely. Clean the inside and opening of the canal (1) thoroughly to get rid of all blood, and then check the apex location again.

Root canal with a chemical solution overflowing from the opening

An accurate apex location cannot be obtained if some chemical solution is overflowing from the canal opening. In this case, clean the canal and its opening, and then perform apex location. It is important to remove any solution overflowing the opening.

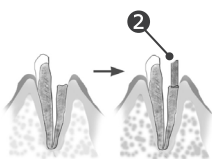

Broken crown

If the crown is broken and a section of the gingival tissue is contacting caries surrounding the canal opening, the Root ZX3 may malfunction due to electrical leakage between the gingival tissue and the root canal. In this case, build up the tooth with a suitable material (2) such as cement, to insulate the gingival tissue.

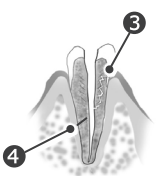

Fractured tooth Leakage through a branch canal

A fractured tooth (3) will cause electrical leakage and accurate apex location cannot be obtained. A branch canal (4) will also cause electrical leakage and accurate apex location cannot be obtained.

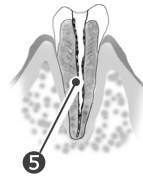

Re-treatment of a root filled with gutta-percha

The gutta-percha (5) must be completely removed to eliminate its insulating effect.

After removing the gutta-percha, pass a small file all the way through the apical foramen, and then put a little saline in the canal, but do not let it overflow the canal opening.

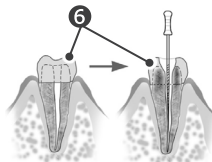

Crown or metal prosthesis touching gingival tissue

The Root ZX3 will malfunction if the file or reamer touches a metal prosthesis that is touching gingival tissue. In this case, widen the opening at the top of the crown so that the file or reamer will not touch the metal prosthesis (6) before performing the apex location.

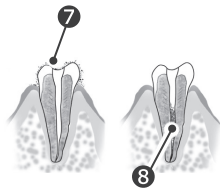

Cutting debris on tooth Pulp inside canal

The Root ZX3 will malfunction if the file or reamer touches a metal prosthesis that is touching gingival tissue. In this case, widen the opening at the top of the crown so that the file or reamer will not touch the metal prosthesis (6) before performing the apex location.



Caries touching the gums

In this case, electrical leakage through the caries infected area to the gums (9) will make it impossible to obtain an accurate apex location.



Blocked canal

The meter will not move if the canal is blocked (10).

In this case, open the canal all the way (penetration) to the apical constriction.



Extremely dry canal

If the canal is too dry, the meter may not move until the file is near the apex.

In this case, try moistening the canal with oxydol or saline.

■ Root ZX3 Meter Reading and Radiography

Sometimes the Root ZX3 meter reading and the X-ray image will not correspond.

This does not mean that the Root ZX3 is not working properly or that the X-ray exposure is a failure.

An X-ray image might not show the apex correctly depending on the angle of the X-ray beam, and the location of the apex might seem to be other than it really is.

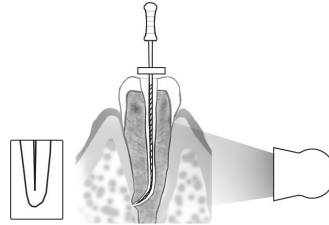

In the illustration to the above, the actual apex for the canal is not the same as that for the anatomical apex.

There are frequently cases where the apical foramen is located up towards the crown.

In these cases, an X-ray might indicate that the file has not reached the apex even though it has actually reached the apical foramen.

5.3 After Use

1 Turn off the device.

 p. 20 “6 Turn off the device.”

2 Unclip the file.

CAUTION

- Be careful when clipping and unclipping files to avoid injury to fingers.

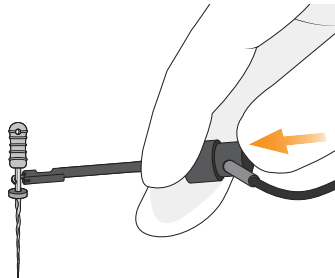

3 Disconnect the probe cord.

-  Do not wind the probe cord around the device.

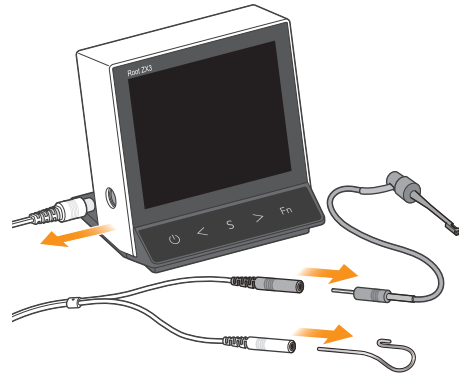

Correct

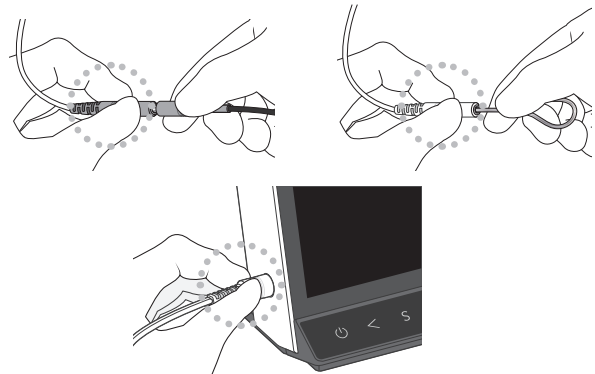

Incorrect

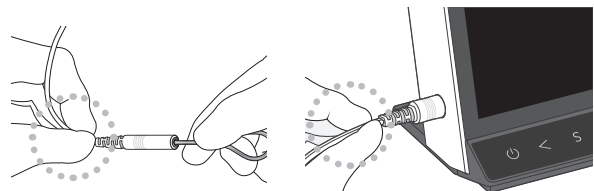

5.4 Reprocessing

Even items designed to be reusable may need to be treated as single patient use or single use and disposed of. Use in accordance with the laws and local regulations of the country or region in which it is used.

Hygiene Plan Guidebook

A reference guidebook of hygiene information about our products is available. Scan the following QR code and visit our website.



In order to view PDF documents, you will need the free Adobe Acrobat Reader distributed by Adobe Inc. Download the latest version via the Adobe website. PDF documents may not be displayed correctly using previous versions.

There are two ways to perform reprocessing depending on the items.

5.4.1 Parts to be Sterilized

p. 28

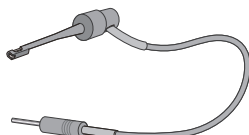

File Holder



Contrary Electrode



Long File Holder

5.4.2 Parts to be Disinfected

p. 31

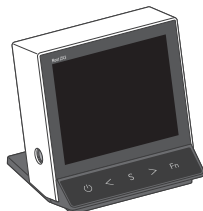

Apex Locator Module

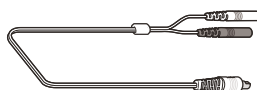

Probe Cord

WARNING

- To prevent the spread of infections, be sure to perform the reprocessing procedures after use with each patient.
- Be careful to avoid cross infection when performing reprocessing.
- Always wear personal protective equipment (PPE) such as safety glasses, gloves, a mask, etc. when performing the reprocessing procedures.

CAUTION

- When performing reprocessing, always turn off the device and make sure that the device will not operate.
- Be careful when clipping and unclipping files to avoid injury to fingers.

- After use, perform reprocessing promptly.
- Before reprocessing, make sure that all the parts (e.g., file, file holder, etc.) are separated individually.

Preparation

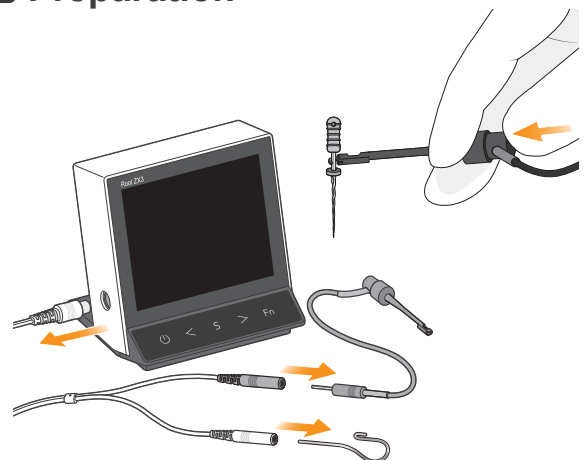

Turn off the device.

Disconnect all parts.

p. 26 "5.3 After Use"

5.4.1 Parts to be Sterilized

* Be sure to perform the reprocessing procedures in the following order promptly after use with each patient.

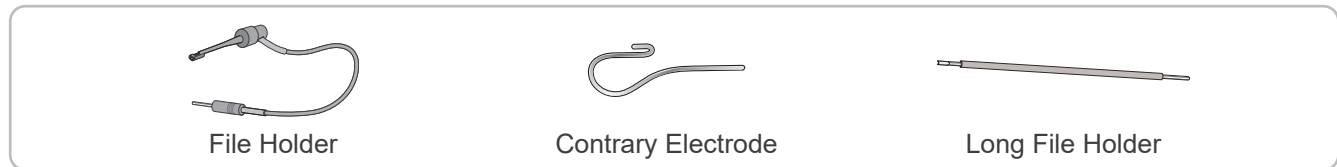

1 Pre-treatment

This must be performed after use with each patient.

- ❗ After use, perform reprocessing promptly. If the parts are left contaminated with blood, it will be difficult to remove.
- ❗ Do not use any chemicals that may coagulate proteins before cleaning.
- ❗ If a medical agent being used for the treatment has adhered to the part, wash it off under tap water.
- ❗ Be careful not to tug on the cord when you clean the file holder. This could cause the wire to break.
- ❗ Do not clean the parts with an ultrasonic cleaning device.

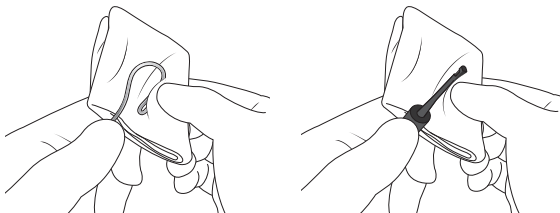
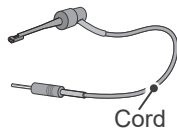

Wipe the parts with a piece of gauze or microfiber cloth (e.g., Toraysee for CE - Medical Equipment and Instruments Maintenance Cloth) that has been dampened with tap water to remove visible contaminants.

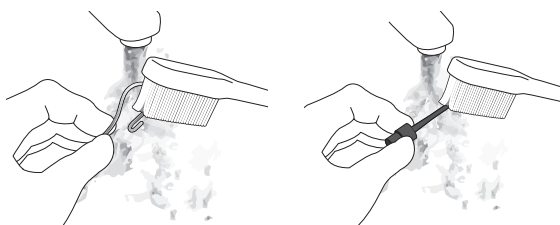

Alternatively, clean the parts in running water with a soft brush to remove visible contaminants.

2 Cleaning & Disinfection

⚠ WARNING

- If any moisture is left inside the parts after cleaning, it could cause corrosion or poor sterilization. Also, the remaining water may come out during use. After cleaning, use a syringe or compressed air to expel remaining moisture.

⚠ CAUTION

- Dust and other impurities adhering to the file holder's electrical contacts or hook can cause the device to malfunction.



- ❗ Be sure to remove visible contaminants before this step.
☞ "1 Pre-treatment"
- ❗ Be sure to use washer-disinfectors that conform to ISO 15883-1 (must be capable of achieving disinfection values of not less than $A_0 = 3000$).
- ❗ If your region is susceptible to hard water scale buildup, use deionized water (ion-exchanged water).
- ❗ For details on handling detergents and neutralizers, concentration, water quality as well as parts washing baskets, refer to the accompanying instructions for use for the washer-disinfectant.
- ❗ Inappropriate cleaning methods and solutions may damage the parts.
- ❗ Do not use strong acidic or alkaline chemicals that could cause the metal to corrode.
- ❗ Do not start drying when the interior of the part is filled with water. Otherwise, this could result in corrosion of the part due to condensation of the rinsing solution.
- ❗ After completing the cleaning process, expel remaining moisture inside the parts with compressed air.
- ❗ Do not leave the parts in the washer-disinfectant. This may cause corrosion or malfunction of the parts.
- ❗ Parts' surface may get scratched and wear out during the cleaning process due to contact with the parts washing basket or other parts. Replace the parts as necessary depending on degree of scratches and wear.



Recommended Conditions for Washer-Disinfectors

Unit Name	Miele G7881
Mode	Vario TD (cleaning time: 5 minutes)
Detergent (concentration)	neodisher MediClean (0.3% to 0.5%)
Rinse (concentration)	neodisher MediKlar (0.03% to 0.05%)

* After cleaning there may be streaks or white spots on the parts. Use a neutralizer only if there are streaks or white spots.

Put parts in the parts washing basket.

Select the washer-disinfector's mode as shown in the table above and start the process.

After completing the cleaning process, make sure the parts are thoroughly clean.

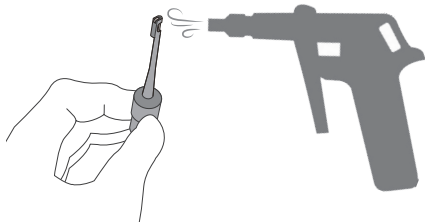

Expel remaining moisture on the surface or inside the parts with compressed air.

3 Packing

- ! Use sterilization pouches that conform to ISO 11607.
- ! Do not use any sterilization pouches that contain hydro-soluble adhesive ingredients such as PVA (polyvinyl alcohol).
Note that even ISO 11607 conformable sterilization pouches may contain PVA.
- ! When placing a part in a sterilization pouch, be sure not to put stress on the part (e.g., cord).

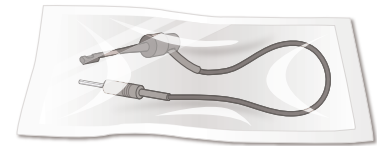

Place the parts individually in a sterilization pouch.
Use only FDA-cleared pouches. (Only for U.S.A.)

4 Sterilization

⚠ WARNING

- To prevent the spread of infections, the parts must be autoclaved after each patient's treatment has been completed.

⚠ CAUTION

- Parts are extremely hot right after autoclaving. Wait for them to cool off before touching.

- ❗ Do not sterilize the parts by any method other than autoclaving.
- ❗ If chemical solutions or foreign debris are not removed, autoclaving could damage or discolor the part. Thoroughly clean and disinfect the parts before autoclaving.
- ❗ The setting temperature for sterilization and drying process must be +135°C (+275°F) or lower. If the temperature is set at beyond +135°C (+275°F), it may cause a malfunction or stain on the parts.
- ❗ Do not autoclave any parts other than the file holder and contrary electrode.
- ❗ Take the file out of the file holder before autoclaving.
- ❗ Follow the manufacturer's recommendations for autoclaving files.
- ❗ After completing the autoclaving process, do not leave the parts in the autoclave.

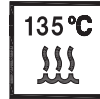

Recommended Autoclave Settings

Country: U.S.A.

Sterilizer Type	Temperature	Time	Drying Time after Sterilization
Gravity	+132°C (+269.6°F)	15 minutes	15 minutes
	+121°C (+249.8°F)	30 minutes	

Country: Other than U.S.A.

Sterilizer Type	Temperature	Time	Drying Time after Sterilization
Dynamic Air Removal	+134°C (+273.2°F)	3 minutes	10 minutes
	+134°C (+273.2°F)	5 minutes	
Gravity	+134°C (+273.2°F)	Min. 6 minutes	Min. 10 minutes
	+121°C (+249.8°F)	Min. 60 minutes	

Autoclave the autoclavable parts.

After autoclaving, store the parts in a clean and dry environment.

5.4.2 Parts to be Disinfected

* Be sure to perform reprocessing procedures in the following order promptly after use with each patient.

Pre-treatment → Cleaning & Disinfection



Apex Locator Module

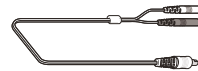

Probe Cord

1 Pre-treatment

This must be performed after use with each patient.

- ! After use, perform reprocessing promptly. If the parts are left contaminated with blood, it will be difficult to remove.
- ! Do not use any chemicals that may coagulate proteins before cleaning.
- ! If a medical or adhesive agent being used for the treatment has adhered to the part, immediately remove it with a piece of gauze or microfiber cloth (e.g., Toraysee for CE - Medical Equipment and Instrument Maintenance Cloth) that has been dampened with tap water.
- ! Be sure not to tug on the cable or cord when you clean the parts. This could cause the wire to break.

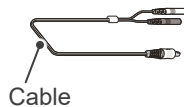

- ! Do not clean the parts with an ultrasonic cleaning device.
- ! Do not wet the electrical contacts.

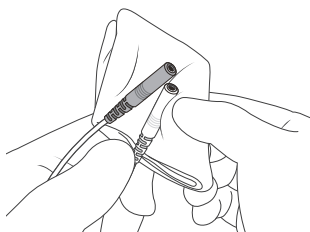

Wipe the parts with a piece of gauze or microfiber cloth (e.g., Toraysee for CE - Medical Equipment and Instruments Maintenance Cloth) that has been dampened with tap water to remove visible contaminants. Then wipe off moisture completely with a soft cloth.

2 Cleaning & Disinfection

- ! Make sure that there is no visible moisture and contamination when wiping the parts.
- ! Be sure not to tug on the cable or cord when you clean the parts. This could cause the wire to break.
- ! Do not use disinfectants other than those designated by J. MORITA MFG. CORP.
- ! For details on handling disinfectants, refer to the accompanying instructions for use for each disinfectant.
- ! If too much disinfectant is applied to the piece of gauze or microfiber cloth, it will seep into the part and cause a malfunction.
- ! Do not immerse the parts in or wipe them with any of the following: functional water (acidic electrolyzed water, strong alkaline solution, and ozone water), medical agents (glutaral, etc.), or any other special types of water or commercial cleaning liquids. Such liquids may result in metal corrosion or adhesion of the residual medical agent to the parts.
- ! Do not clean or immerse the parts with chemicals such as formalin cresol (FC) and sodium hypochlorite. These will damage the metal and plastic parts. Immediately wipe away any chemicals that are accidentally spilled on the parts.

Disinfectants Approved by J. MORITA MFG. CORP.

Disinfectant	Country
Ethanol (70 vol% to 80 vol%)	U.S.A.
Opti-Cide3 (wipes)	
FD333 forte (wipes)	Other than U.S.A.

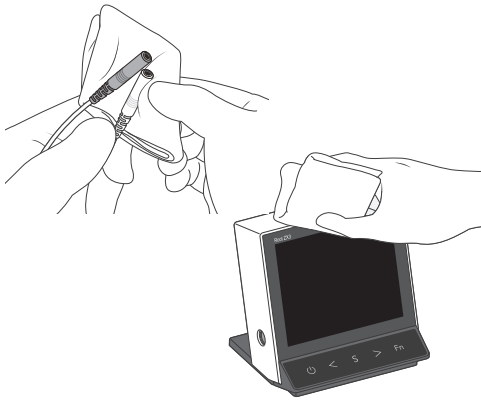

Wipe the part's surface with disinfectants approved
by J. MORITA MFG. CORP.
(Except for the LCD display's clear cover.)

6 How to Modify Various Settings

6.1 Memory Contents

6.1.1 Editable Items and Default Settings

CAUTION

- Always check the settings after changing the memory contents.

The flash bar position and speaker volume can be changed for each memory.

Editable Items

Item (displayed name)	Description
Flash Bar Position (FB.)	Indicates the position inside the root canal that provides a reference for the apex location.
Speaker Volume (VOL.)	Sound volume for switch operation and the indication of the file tip position inside the root canal.

Default Settings

The default memory settings are listed below. These settings can be changed as needed.

Item (displayed name)	M1	M2	M3
Flash Bar Position (FB.)	32 (0.5 meter reading)		
Speaker Volume (VOL.)	2		

6.1.2 Procedures

1 Turn on the device.

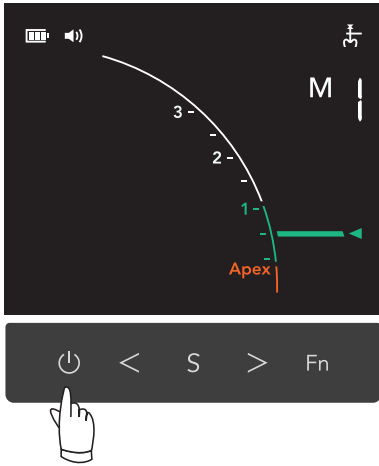

2 Select a memory number.

⚠ CAUTION

- Always check the settings of the selected memory before use.

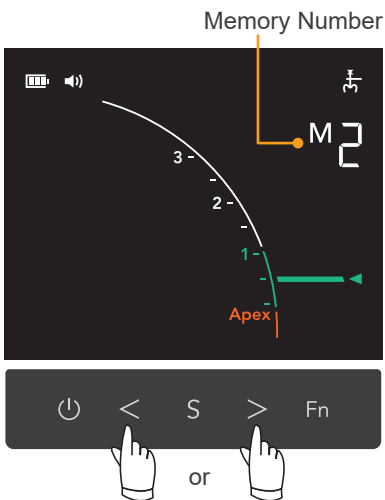

3 Select an editable item.

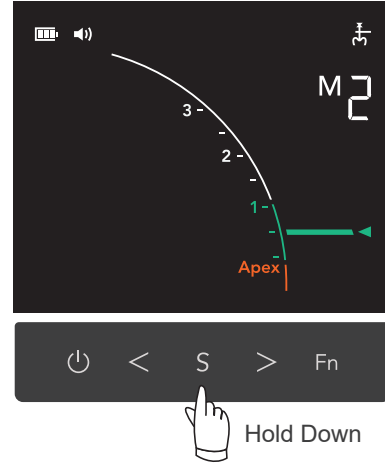

Hold down **S** more than 1 second to switch the display into flash bar position configuration screen.

Press **S** to switch the items.

FB. : Flash Bar Position
↕
VOL. : Speaker Volume

4 Change the settings.

● Flash Bar Position



The flash bar position can be set between meter gauge 2 (FB.20) and the Apex (FB.36).

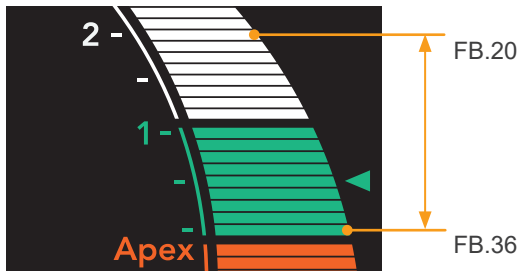

Meter Gauge Display and Flash Bar Display

Meter Gauge Display	Flash Bar Display Value
2	FB.20
1	FB.28
0.5 ◀	FB.32
Apex	FB.36

● Speaker Volume



VOL.0 🔇 VOL.1 🔊 VOL.2 🔊 VOL.3 🔊

5 Complete configuration.

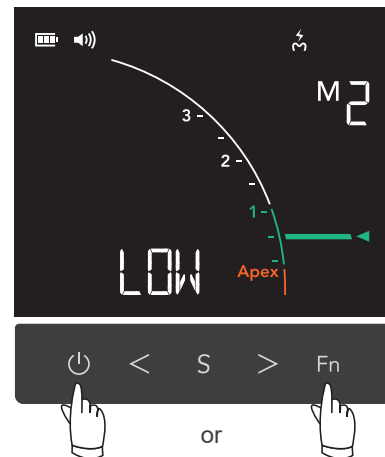

One of the following actions completes the change and the memory settings will be saved.

- Press **Fn**.
- Press **Power** to turn off the device.

* If any switches are not used for a defined period of time (standby screen return time), the device will save the changes.

6.2 Other Functions

Speaker tone, auto power off time, screen return time, and LCD brightness can be configured. These settings are common for all memories.

6.2.1 Editable Items and Default Settings

Item (displayed name)	Description	Default Setting
Speaker Tone (SPK.)	Select the tone for apex location. If there are multiple Root ZX3 units, you can set different tone for each unit.	SPK.1
Auto Power Off Time (AP.)	This sets the time it takes for the auto power off function to be triggered when no switches have been pressed.	AP.10
Screen Return Time (SR.)	This shows how long it takes for the device to exit the configuration screen if no switches have been pressed.	SR.10
LCD Brightness (LCD.)	The LCD display brightness can be changed.	LCD.2

6.2.2 Procedures

1 Turn on the device while holding down **S**.

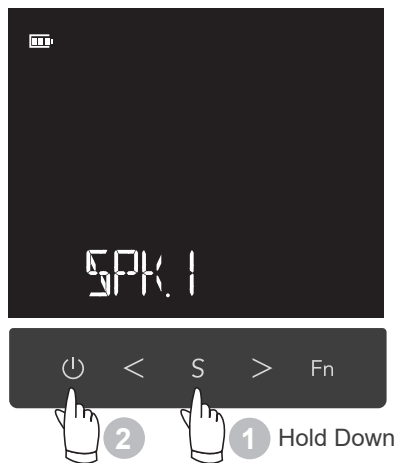

2 Select an editable item.

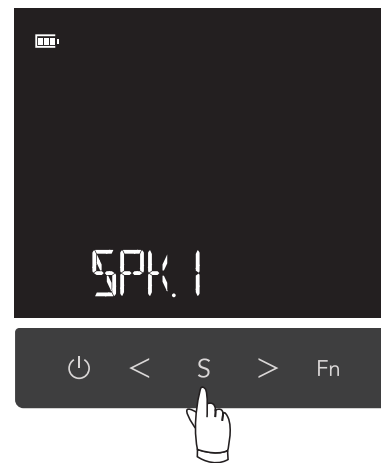

Press **S** to switch the items.

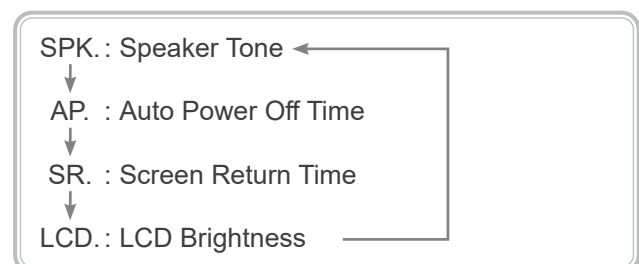

3 Change the settings.

● Speaker Tone

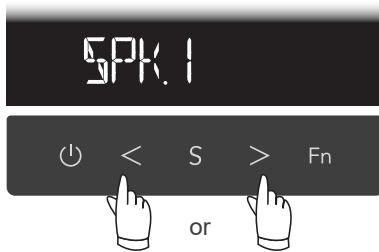

Select the tone for apex location.

SPK.1: A three-toned beep will sound.
SPK.2: A continuous short beep will sound.

● Auto Power Off Time

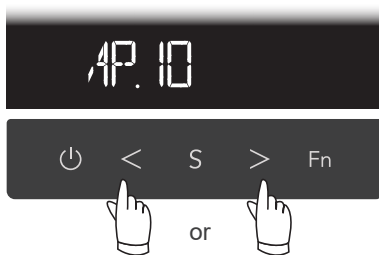

AP.03 – AP.15

● Screen Return Time



SR.03 – SR.15

● LCD Brightness

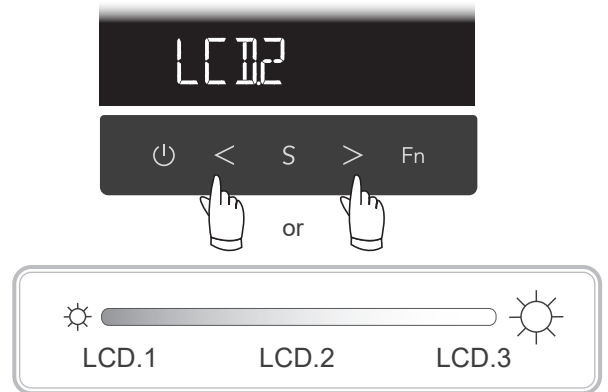

4 Complete the settings.

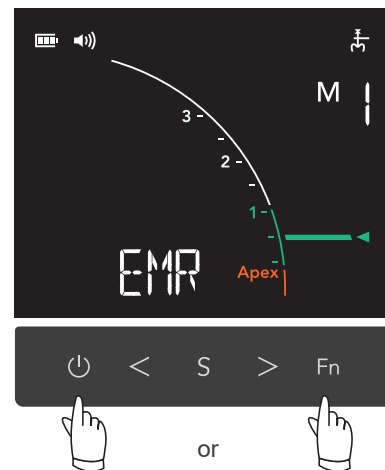

One of the following actions completes the change and the settings will be saved.

- Press **Fn**.
- Press **Power** to turn off the device.

* If any switches are not used for a defined period of time (auto power off time), the device will automatically turn it off and save the changes.



6.3 Resetting the Default Settings

All memories and other function settings will revert to their original default settings.

* This operation will affect all memories (M1, M2, M3) and other function settings.
It is not possible to initialize just one of them.

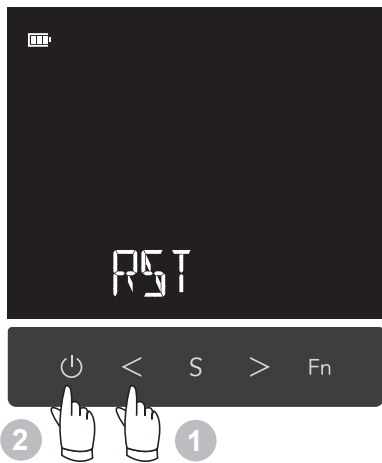
1 Turn on the device while holding down .



While the device power is off, hold down  and press .
“RST” is displayed.

2 Reset the memory settings.

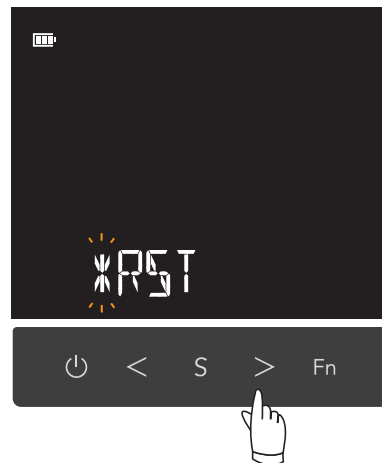

 blinks and the initialization starts.



After approximately 2 seconds, the memory settings will reset and “FIN” will be displayed.

7 Troubleshooting

7.1 Troubleshooting

If the Root ZX3 does not seem to be working properly, the user should first try to inspect and adjust it themselves.

* If you cannot inspect the device yourself or if the device fails to work properly after being adjusted or after parts are replaced, contact your local dealer or J. MORITA OFFICE.

Symptoms	Check Points	Possible Cause / Remedies	Ref. Page
Cannot turn on the device.	Are the dry batteries installed properly?	Check the dry batteries' installation.	p. 14
	Is the battery power level low?	Replace all the dry batteries with new ones.	p. 14
The device turns off by itself.	Have you left the device unoperated for a long time?	The auto power off function was triggered. Press the power switch to turn on the device again.	p. 37
Display does not appear.	Is there a sound when the unit is turned on and off?	If there is no sound, replace all the dry batteries with new ones. If there is a sound but still no display after replacing the dry batteries, the LCD display may be broken.	N/A
No sound from the speaker.	Is the speaker volume set for "VOL.0"?	Set it for "VOL.1", "VOL.2", or "VOL.3".	p. 34
Cannot switch the memory number. Cannot change the memory settings.	Is apex location being performed?	You cannot operate anything other than the power switch during apex location.	N/A
	Does any switch work?	If it does not, it may be broken. Have the device professionally repaired.	p. 48
Cannot perform apex location	Is the contrary electrode properly hooked in the corner of the patient's mouth?	Hook it in the corner of the patient's mouth.	p. 18
	Are all cords properly connected?	Make sure all connectors are plugged in all the way.	p. 16
	Is a wire in the probe cord broken?	Touch the contrary electrode with the clip on the end of the file holder and check that all the apex location indicator bars on the meter in the LCD display light up.	p. 17
The display of the apex location indicator bars is unstable.	Does the contrary electrode properly touch the patient's mouth?	Adjust the contrary electrode position to touch the patient's oral mucosa properly so that the display stabilizes.	p. 18
	Is the file holder dirty?	Wipe the file holder and clean it off.	p. 28

Symptoms	Check Points	Possible Cause / Remedies	Ref. Page
<p>The display of the apex location indicator bars makes abnormal movements as follows.</p> <ul style="list-style-type: none"> • Too short • Inaccurate • Too sensitive 	Does blood or chemical solution overflow from the opening of the root canal, or does blood or chemical solution contact the gums?	If blood or chemical solution has overflowed from the root canal, or if it has adhered to a crown or cervical area, the meter will suddenly light up all the way due to electrical shorting from the gums. In this case, clean the canal, crown, and cervical area.	p. 24
	Is the root canal filled with blood or chemical solution?	The meter suddenly will light up all the way when the file contacts with blood or chemical solution. In this case, advancing the file down the root canal will resume the meter display in the correct position and the apex location can be obtained properly.	p. 24
	Does cutting debris or chemical solution remain on the tooth?	Thoroughly remove all cutting debris and chemical solutions from the tooth.	p. 24
	Is the file touching the gums?	This will result in electrical leakage and the apex location indicator bars light up all the way. Do not touch the gums with the file.	p. 19
	Does pulp remain inside the canal?	If significant pulp remains inside the canal, an accurate apex location may not be obtained.	p. 24
	Is the file touching a metal prosthesis?	This will result in electrical leakage and the apex location indicator bars light up all the way. Do not touch the metal prosthesis with the file.	p. 24
	Is there a caries?	Electrical leakage through the caries infected area to the gums will make it impossible to obtain an accurate apex location.	p. 24
	Is there a branch or root fracture?	Branch's opening or root fracture could result in electrical leakage to the periodontal membrane and displays the apex.	p. 24
	Is a large part of the crown broken resulting in electrical leakage to the gums? Is there a periapical lesion?	If there is a periapical lesion, physiological tissue is absorbed and accurate apex location may not be obtained. Build up the tooth with a suitable material to avoid electrical leakage to the gums.	p. 24
	Is the file holder broken?	Replace it with a new one.	p. 19
Is the file holder dirty?	Clean it thoroughly.	p. 28	
<p>The meter of the apex location indicator bars does not move.</p> <p>(It moves only near the apex.)</p>	Is it a blocked canal?	Open the canal all the way (patency) to the apical constriction.	p. 24
	Is the apical foramen open?	If the apical foramen is open or a tooth's apex is immature, the meter may make a sudden and large movement near the apex.	p. 24
	Is the canal extremely dry?	Moisturize the inside of the canal with oxydol or saline.	p. 19

7.2 Error Numbers

If an error or problem is detected, the Root ZX3 will stop working, an error number will appear in the LCD display, and an alarm will sound.

Turn the device off and then back on again. If the error message appears again, stop using the device immediately and contact your local dealer or J. MORITA OFFICE.

Make a note of the error number as well as the device serial number and report it when requesting support.

Error No.	Problems
ERR.0	Apex location error
ERR.1	Apex locator module's memory error
ERR.2	Speaker malfunction
ERR.3	Communication error between the modules
ERR.5	Battery power error

E.g., ERR.0 screen display

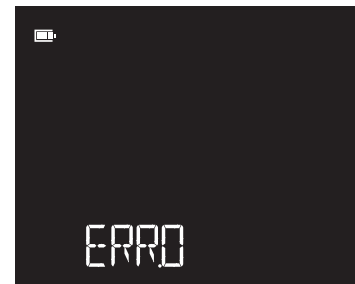

8 Replacement Parts

8.1 Parts Replacement

* Replace the parts as necessary depending on degree of wear and length of use.



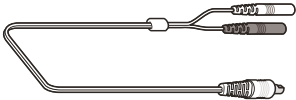

* Order parts from your local dealer or J. MORITA OFFICE.

* For instructions on how to replace the dry batteries;  p. 14 "5.1.1 Install the Dry Batteries."

■ Replacement Parts

Probe Cord	
	Code No. 8449422
	

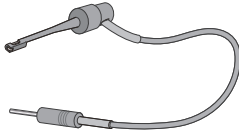
■ Consumables

File Holders	Contrary Electrodes	Long File Holders
		
Code No.: 7503670	Code No.: 7503680	Code No. 7503674
		

9 Electromagnetic Disturbances (EMD)

The Root ZX3 (Model: RZX3, hereafter “this device”) conforms to IEC 60601-1-2 Edition 4.1, the relevant international standard for electromagnetic disturbances (EMD).

Use Environment

The use environment of this device is the PROFESSIONAL HEALTHCARE FACILITY ENVIRONMENT.

WARNING

- Use of this equipment adjacent to or stacked with other equipment should be avoided because it could result in improper operation. If such use is necessary, this equipment and the other equipment should be observed to verify that they are operating normally.
- Use of accessories, transducers and cables other than those specified or provided by us could result in increased electromagnetic emissions or decreased electromagnetic immunity of this equipment and result in improper operation.
- Portable RF communications equipment (including peripherals such as antenna cables and external antennas) should be used no closer than 30 cm (12 inches) to any part of the RZX3, including cables specified by the manufacturer. Otherwise, degradation of the performance of this equipment could result.

Cable List

No.	Name	Cable Length, Shielding	SIP/SOP & In/Out Port Type
1	Probe Cord	1.9 m, Un-shielded	PATIENT-Coupled Cable

Compliance for Each EMISSIONS and IMMUNITY Standards

Emissions Test	Compliance	Electromagnetic Environment – Guidance
RF emissions CISPR 11	Group 1 Class B	This device is suitable for use in all establishments, including domestic establishments and those directly connected to the public low-voltage power supply network that supplies buildings used for domestic purposes.
RF emissions CISPR 11	Group 1 Class B	
Harmonic emissions IEC 61000-3-2* ¹	N/A	
Voltage fluctuations/flicker emissions IEC 61000-3-3* ¹	N/A	

*¹ The test is not applicable since the EUT does not have AC power input ports.

Immunity Test	IEC 60601 Test Level	Compliance Level	Electromagnetic Environment – Guidance
Electrostatic discharge (ESD) IEC 61000-4-2	<u>Contact</u> ±8 kV <u>Air</u> ±2 kV, ±4 kV, ±8 kV, ±15 kV	<u>Contact</u> ±8 kV <u>Air</u> ±2 kV, ±4 kV, ±8 kV, ±15 kV	Floors should be wood, concrete or ceramic tile. If floors are covered with synthetic material, the relative humidity should be at least 30%.
Electrical fast transients/bursts IEC 61000-4-4	<u>Power Supply Lines</u> ±2 kV <u>Input/Output Lines</u> ±1 kV	<u>Power Supply Lines</u> ^{*1} ±2 kV <u>Input/Output Lines</u> ^{*2} ±1 kV	Mains power quality should be that of a typical commercial or hospital environment.
Surge IEC 61000-4-5	<u>Input Power Ports</u> ±0.5 kV, ±1 kV line(s) to line(s) ±0.5 kV, ±1 kV, ±2 kV line(s) to earth <u>Signal Input/Output</u> ±2 kV line(s) to earth	<u>Input Power Ports</u> ^{*1} ±0.5 kV, ±1 kV line(s) to line(s) ±0.5 kV, ±1 kV, ±2 kV line(s) to earth <u>Signal Input/Output</u> ^{*3} ±2 kV line(s) to earth	Mains power quality should be that of a typical commercial or hospital environment.
Voltage dips, short interruptions and voltage variations on power supply lines IEC 61000-4-11 ^{*1}	<u>Dips</u> 0% U_T : 0.5 cycle (at 0, 45, 90, 135, 180, 225, 270, 315°) 0% U_T : 1 cycle (at 0°) 70% U_T : 25/30 cycles (at 0°) 25(50Hz)/30(60Hz) <u>Short Interruptions</u> 0% U_T : 250/300 cycles 250(50 Hz)/300(60 Hz)	<u>Dips</u> 0% U_T : 0.5 cycle (at 0, 45, 90, 135, 180, 225, 270, 315°) 0% U_T : 1 cycle (at 0°) 70% U_T : 25/30 cycles (at 0°) 25 (50 Hz)/30 (60 Hz) <u>Short Interruptions</u> 0% U_T : 250/300 cycles 250 (50 Hz)/300 (60 Hz)	Mains power quality should be that of a typical commercial or hospital environment. If user of this device requires continued operation during power mains interruptions, it is recommended that this device be powered from an uninterruptible power supply or a battery.
Power frequency (50/60 Hz) magnetic field IEC 61000-4-8	30 A/m (r.m.s) Select from 50 Hz, 60 Hz as required	30 A/m (r.m.s) 50 Hz and 60 Hz	Power frequency magnetic field should be at levels characteristic of a typical location in a typical commercial or hospital environment.
Proximity magnetic fields IEC 61000-4-39	<u>30 kHz</u> CW, 8 A/m <u>134.2 kHz</u> 2.1 kHz, 65 A/m <u>13.56 MHz</u> 50 kHz, 7.5 A/m	<u>30 kHz</u> CW, 8 A/m ^{*4} <u>134.2 kHz</u> 2.1 kHz, 65 A/m <u>13.56 MHz</u> 50 kHz, 7.5 A/m	The proximity magnetic field should be at a level characteristic of magnetic fields emitted from RFID, IH (Induction Heating), etc.
Note: U_T is the a.c. mains voltage prior to application of the test level. r.m.s (root mean square)			

^{*1} This test is not applicable since the EUT does not have Power input ports.

^{*2} This test is not applicable since the EUT signal cable is less than 3 m.

^{*3} Not applicable because it does not connect directly to outdoor cable.

^{*4} This test is not applicable since the EUT is not intended for use in the HOME HEALTHCARE ENVIRONMENT.

Immunity Test	IEC 60601 Test Level	Compliance Level	Electromagnetic Environment – Guidance
Conducted RF IEC 61000-4-6	3 V 0.15 MHz to 80 MHz 6 V ISM bands between 0.15 MHz and 80 MHz ^(c)	3 V 0.15 MHz to 80 MHz 6V ISM bands between 0.15 MHz and 80 MHz ^(c)	Portable and mobile RF communications equipment should be used no closer to any part of this device, including cables, than the recommended separation distance calculated from the equation applicable to the frequency of the transmitter.
Radiated RF IEC 61000-4-3	3 V/m 80 MHz to 2.7 GHz	3 V/m 80 MHz to 2.7 GHz	
	27 V/m 385 MHz	27 V/m 385 MHz	Recommended separation distances
	28 V/m 450 MHz	28 V/m 450 MHz	$d = \frac{6}{E} \sqrt{P}$
	9 V/m 710, 745, 780 MHz	9 V/m 710, 745, 780 MHz	Where P is the maximum output power rating of the transmitter in watts (W) according to the transmitter manufacturer, E is the compliance level in V/m and d is the recommended separation distance in meters (m).
	28 V/m 810, 870, 930 MHz	28 V/m 810, 870, 930 MHz	
	28 V/m 1720, 1845, 1970 MHz	28 V/m 1720, 1845, 1970 MHz	
	28 V/m 2450 MHz	28 V/m 2450 MHz	Field strengths from fixed RF transmitters, as determined by an electromagnetic site survey ^(a) , should be less than the compliance level in each frequency range ^(b) .
	9 V/m 5240, 5500, 5785 MHz	9 V/m 5240, 5500, 5785 MHz	Interference may occur in the vicinity of equipment marked with the following symbol: 

Note: These guidelines may not apply in all situations. Electromagnetic propagation is affected by absorption and reflection from structures, objects and people.

^(a) Field strengths from fixed transmitters, such as base stations for ratio (cellular/cordless) telephones and land mobile radios, amateur radio, AM and FM radio broadcast and TV broadcast cannot be predicated theoretically with accuracy. To assess the electromagnetic environment due to fixed RF transmitters, an electromagnetic site survey should be considered. If the measured field strength in the location in which this device is used exceeds the applicable RF compliance level above, this device should be observed to verify normal operation. If abnormal performance is observed, additional measures may be necessary, such as reorienting or relocating this device.

^(b) Over the frequency range 0.15 MHz to 80 MHz, field strengths should be less than 3 V/m.

^(c) The ISM (Industrial, Scientific and Medical) bands between 0.15 MHz and 80 MHz are 6.765 MHz to 6.795 MHz; 13.553 MHz to 13.567 MHz; 26.957 MHz to 27.283 MHz; and 40.66 MHz to 40.70 MHz.

10 Technical Specifications

10.1 Specifications

* Specifications may be changed without notice due to improvements.

Name	Root ZX3	
Model	RZX3	
Type	RCM	
Operating Principle	The Apex Locator module has the apex locating function achieved by measuring the electrical impedance between the active electrode and the neutral electrode, which makes it possible to measure the root canal length. Apex position is detected and the root canal length and working length can be determined with reference to this apex position.	
Essential Performance	None (There is no unacceptable risk.)	
Protection Against Ingress of Water	IPX0	
Degree of Protection against Electric Shock	Internal power supply device / Type BF applied part	
Applied Parts	File holder, Contrary electrode	
Rated Input Voltage	Solo operation: DC 6 V (alkaline dry batteries [AA size], Qty: 4) Connected with HF Module: DC 9.6 V (Ni-MH battery)	
Dimensions (Approx.)	RCM Module	100 mm (Height) × 95 mm (Width) × 85 mm (Depth)
	Contrary Electrode	2 mm (Diameter) × 65 mm (Length)
Weight (Approx.)	390 g (with dry batteries)	

10.2 Symbols

* Some symbols may not be used.

	Manufacturer		Date of manufacture
	Serial number		Lot Number
	Model number		GS1 DataMatrix
	Medical device		Unique device identifier
	Importer		Distributor
	Packaging unit		Sterilize components before use
	Supports washer-disinfectors		Autoclavable up to 135°C (+275°F)
	Type BF applied part		Direct current
	Fragile		This way up
	Keep away from rain		Temperature limitation
	Atmospheric pressure limitation		Humidity limitation
	Refer to instructions for use		Consult instructions for use or electronic instructions for use
	Prescription Device CAUTION: Federal law restricts this device to sale by or on the order of a dentist. (Valid only for U.S.A.)		cTUVus certification mark (Valid only for U.S.A. and Canada)
	CE (0197) marking Conforms with the European Directive, 93/42/EEC CE marking Conforms with the European Directive, EU 2011/65		Marking of electrical Equipment in accordance with the European Directive, EU 2012/19 (WEEE)
	EU Authorized Representative under the European Directive, 93/42/EEC		

11 Regular Inspection

11.1 Regular Inspection

* Regular inspection is generally considered to be the duty and obligation of the user, but, if, for some reason, the user is unable to carry out this duty, this may be performed by the accredited service personnel. Contact your local dealer or J. MORITA OFFICE for details.

* The Root ZX3 should be inspected every 6 months in accordance with the following regular inspection items.

* For repair or other types of service, contact your local dealer or J. MORITA OFFICE.

* J. MORITA MFG. CORP. will offer replacement parts and service for the product for a period of 10 years after the manufacturing of the product has been discontinued. Replacement parts and service will continue to be available during that period.

11.1.1 Regular Inspection Items

Inspection Item		Check Point
1	Switches	Check that the device turns on when the power switch is pressed, and that the unit turns off when the power switch is pressed again.
		Check that the memory number (M1, M2, M3) is changed when the forward or reverse switch is pressed.
		Check the settings for each of the memories can be changed when the select or function switch is pressed.
2	Probe Cord (plug and connectors)	Visually inspect the probe cord and its plug and connectors carefully and make sure that they are not damaged or dirty.
		Check that the plug of the probe cord goes into the apex locator module's connection port properly.
3	File Holder Contrary Electrode	Visually inspect the file holder and contrary electrode carefully and make sure that they are not damaged or dirty.
		Check that the file holder plug fits properly into its probe connector (gray).
		Check that the file holder holds a file properly.
		Check that the contrary electrode fits properly into its probe connector (white).
4	Apex Location Indicator Bar	Touch the contrary electrode with the file holder contact and check the following points. All of the apex location indicator bars light up. "OVER", "Apex", and "◀" (0.5 meter reading) blink. A continuous beep sounds.

12 Service and Disposal

12.1 Service

For repair or other types of service, contact your local dealer or J. MORITA OFFICE.

The Root ZX3 may be repaired and serviced by:

- The technicians of J. MORITA's subsidiaries all over the world.
- Technicians employed by authorized J. MORITA dealers and specially trained by J. MORITA.
- Independent technicians specially trained and authorized by J. MORITA.

12.2 Standards and Procedures for Disposal of Medical Devices

The dentist or doctor responsible for the patient's treatment must confirm that a medical device, explants, needles, or surgical equipment are uncontaminated with potentially infectious substances of human origin, and must then have it disposed of by a healthcare facility or an agent licensed and qualified to handle standard industrial waste and industrial waste requiring special treatment.



The battery should be recycled. Metal parts of the device are disposed of as scrap metal. Synthetic materials, electrical components, and printed circuit boards are disposed of as electrical scrap. Material must be disposed of according to the relevant national legal regulations. Consult specialized disposal companies for this purpose. Please inquire of the local administration concerning local disposal companies.

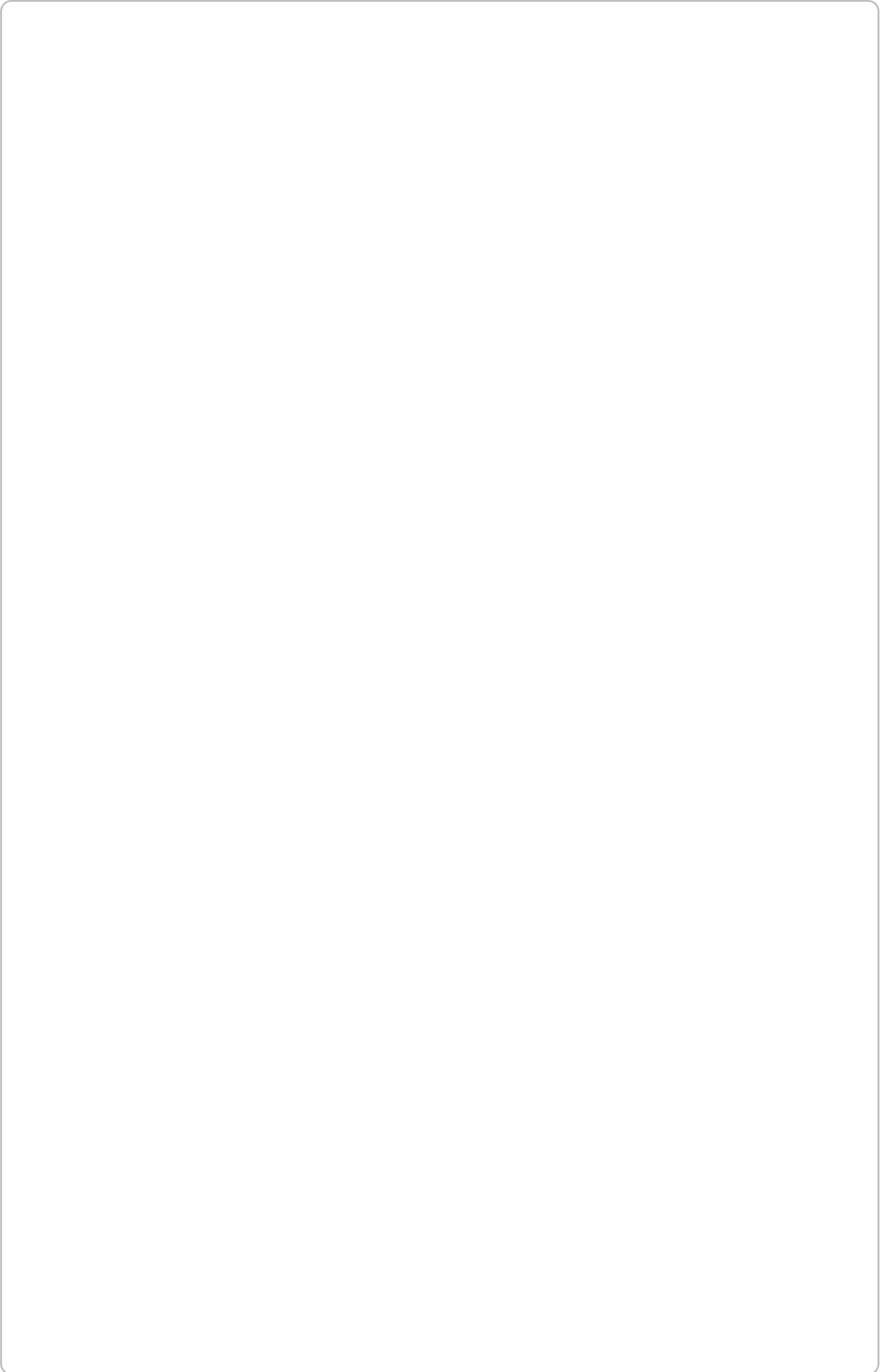



Development and Manufacturing

J. MORITA MFG. CORP.

680 Higashihama Minami-cho, Fushimi-ku, Kyoto 612-8533, Japan
T +81. (0)75. 611 2141, F +81. (0)75. 622 4595

Morita Global Website

www.morita.com

Distribution

J. MORITA CORP.

3-33-18 Tarumi-cho, Suita-shi, Osaka 564-8650, Japan
T +81. (0)6. 6380 1521, F +81. (0)6. 6380 0585

J. MORITA USA, INC.

9 Mason, Irvine CA 92618, USA
T +1. 949. 581 9600, F +1. 949. 581 8811

J. MORITA EUROPE GMBH

Justus-von-Liebig-Strasse 27b, 63128 Dietzenbach, Germany
T +49. (0)6074. 836 0, F +49. (0)6074. 836 299

MORITA DENTAL ASIA PTE. LTD.

150 Kampong Ampat #06-01A KA Centre, Singapore 368324
T +65. 6779. 4795, F +65. 6777. 2279

J. MORITA CORP. AUSTRALIA & NEW ZEALAND

Suite 2.05, 247 Coward Street, Mascot NSW 2020, Australia
T +61. (0)2. 9667 3555, F +61. (0)2. 9667 3577

J. MORITA CORP. MIDDLE EAST

4 Tag Al Roasaa, Apartment 902, Saba Pacha 21311 Alexandria, Egypt
T +20. (0)3. 58 222 94, F +20. (0)3. 58 222 96

J. MORITA CORP. INDIA

Filix Office No.908, L.B.S. Marg, Opp. Asian Paints, Bhandup (West), Mumbai 400078, India
T +91-82-8666-7482

J. MORITA MFG. CORP. INDONESIA

28F, DBS Bank Tower, Jl. Prof. Dr. Satrio Kav. 3-5, Jakarta 12940, Indonesia
T +62-21-2988-8332, F + 62-21-2988-8201

SIAMDENT CO., LTD.

71/10 Moo 5 T. Tharkham A. Bangpakong Chachuengsao 24130 Thailand
T +66 (0) 3857 3042, F +66 (0) 3857 3043
www.siamdent.com

Diagnostic and Imaging Equipment

Treatment Units

Handpieces and Instruments

Endodontic Systems

Laser Equipment

Laboratory Devices

Educational and Training Systems

Auxiliaries

