



Panorama, Cephalo and CT Capabilities

Veraviewepocs 3D

INSTRUCTIONS FOR USE



Thank you for purchasing the Veraviewepocs 3D.

For optimum performance and safety, read this manual thoroughly before using the equipment.

Pay special attention to the cautionary warnings and safety statements.

Keep this manual in a handy place for ready reference.

Trademarks (™) and Registered Trademarks (®):

The names of companies, products, services, etc. used in this manual are either trademarks or registered trademarks owned by each company.

© 2012 J. MORITA MFG. CORP.

Table of Contents

	Page
Prevent Accidents	3
For Safe Operation	5
Parts Identification	8
1. Parts Identification.....	8
2. Patient Frame and Arm Operation Panels.....	11
3. Patient Positioning Tools and Consumable Parts.....	16
Operation.....	17
i. Preliminary Procedures.....	17
ii. Operation Procedures.....	20
1. Safety Check.....	20
2. Panorama Exposures.....	21
(1) Turn main switch on.....	21
(2) Emergency Switch.....	21
(3) Panorama Settings.....	22
(3)-1 Auto Exposure(Digital Direct Auto Exposure).....	22
(3)-2 Manual Exposure.....	23
(3)-3 No X-ray Setting.....	23
(4) Patient Positioning.....	24
(5) Panorama Exposure.....	32
(6) Patient Egress and Image Transmission.....	34
(7) Varieties of Panorama Exposures.....	38
(7)-1 Dental Arch Panorama.....	38
(7)-2 Maxillary Sinus(Mag.: 1.5×, throughout).....	42
(7)-3 TMJ Quadruple(Mag.: 1.3×, throughout).....	44
(8) Mouth Closed Exposure(First Exposure).....	49
(9) Open Mouth Exposure(Second Exposure).....	50
3. Cephalo Exposures (option).....	51
(1) Turn Main switch On.....	51
(2) Emergency Stop Switch.....	52
(3) Lateral Exposure.....	53
(4) Patient Positioning.....	55
(5) X-ray Emission.....	59
(6) Patient Egress and Image Transmission.....	61
(7) PA (posterior-anterior) Exposure.....	63
(8) Notes for Exporting Digital Cephalo Data for Software Analysis.....	66

	Page
4. CT Exposure	67
(1) Turn Main switch On	68
(2) Emergency Stop Switch	68
(3) CT Exposure Sizes	69
(4) Limited Field CT Exposure	70
(4)-1 CT Exposure Settings	70
(4)-2 Exposure Types	71
(4)-3 Exposure Conditions	73
(5) Patient Positioning	75
(6) X-ray Emission	79
(7) Patient Egress and Image Transmission	81
(8) Panorama Scout	83
(9) Two-direction Scout	89
(10) X-ray Emission	93
(11) Dental Arch CT Exposures	97
(11)-1 Set CT Exposure Mode	97
(11)-2 Region and FOVs	98
(11)-3 Exposure Conditions	99
(11)-4 Patient Positioning	100
(11)-5 X-ray Emission	105
(11)-6 Patient Egress and Image Transmission	107
iii. After Use	108
Maintenance, Parts Replacements, and Storage.....	109
1. Disinfection	109
(1) Regular Maintenance	109
2. Replacement Parts	110
3. Storage and Transportation	110
Regular Inspection	111
Service Life, Consumables, and Replacement Parts	114
Trouble shooting	116
Cautionary Remarks on Imaging	127
DDAE Verification Procedure	141
Technical Specifications	146
1. Specifications	146
2. Symbols and Markings	159
Electromagnetic Disturbances (EMD)	163

* This manual covers a fully equipped model; refer to the sections covering the instruments and functions of your own unit.

Prevent Accidents

ATTENTION CUSTOMERS

Do not fail to receive clear instructions concerning the various ways to use this equipment as described in this accompanying Manual.

To access the warranty information for this product, scan the following QR code and visit our website.



ATTENTION DEALERS

Do not fail to give clear instructions concerning the various ways to use this equipment as described in this accompanying Manual.

SAFETY INSTRUCTIONS AND RECORDING INFORMATION

When the Veraviewepocs 3D is installed, the installer or other responsible party must explain the precautions and usages in the Instructions for Use to the user and the person responsible for maintenance and management.

In accordance with the laws of the relevant country or region, information such as the installation date, explained contents, the name of operator and healthcare facility's maintenance representative, and the name of the installer or other responsible party, may need to be recorded.

PREVENT ACCIDENTS

Most operation and maintenance problems result from insufficient attention being paid to basic safety precautions and not being able to foresee the possibilities of accidents. Problems and accidents are best avoided by foreseeing the possibility of danger and operating the unit in accordance with the manufacturer's recommendations. First thoroughly read all precautions and instructions pertaining to safety and accident prevention; then, operate the equipment with the utmost caution to prevent either damaging the equipment itself or causing bodily injury.

Note the meaning of the following symbols and expressions:



This warns the user of danger of death, serious bodily injury or total instrument damage and failure or fire.



This alerts the user to the risk of light to medium injury or instrument damage.



This alerts the user of important points concerning operation.

The user (e.g., healthcare facility, clinic, hospital etc.) is responsible for the management, maintenance, and use of medical devices.

Disregarding the information on safety is considered ABNORMAL USE.

Do not use this equipment for anything other than its specified dental treatment purpose.

Caution: Federal law restricts this device to sale by or on the order of a dentist (for U.S.A.).

INTENDED OPERATOR PROFILE

a) Qualification:

Legally qualified person such as radiologic technician and dentists for X-ray device operation (it may differ among countries).

b) Education and Knowledge:

It is assumed that the user understands the risks of X-rays and the protective steps required. It is also assumed that the user is thoroughly familiar with X-ray diagnosis, anatomy, and hygiene including the prevention of cross contamination.

c) Language Understanding:

English (Intended for professional use as described above.)

d) Experience:

Experienced person with operating X-ray devices.

No special training is required except in cases where this is required by legal regulations of the relevant country or region.

RELATED DOCUMENTS

- Installation Instructions

THE USEFUL LIFE

- The useful life of the Veraviewepocs 3D is 10 years from the date of installation provided it is regularly and properly inspected and maintained.
- J. MORITA MFG. CORP. will supply replacement parts and be able to repair the product for a period of 10 years after the manufacture of the product has been discontinued.

For Safe Operation

WARNING

- Do not use the wireless transmission devices listed below in the examination area:
 1. Mobile terminals and smart devices.
 2. Wireless transmitting devices such as ham radios, walkie-talkies, and transceivers.
 3. Personal Handy-phone System (PHS)
 4. Routers for intra-building paging systems, wireless LAN, cordless analogue telephones, and other electric wireless devices.
- Interference from the Veraviewepocs 3D, devices listed below might malfunction or operate in a random, unexpected and dangerous manner.
 1. Electrical diagnostic, examination or treatment devices.
 2. Personal computers
- The Veraviewepocs must be installed in an X-ray shield location. Local regulation for radiation protection must be observed.
- The control box and emission button must be installed in a radiation protected area.
- If the Veraviewepocs is not enclosed by an X-ray booth or other protective barrier, everyone except the patient must stay outside the area shown in the illustration during X-ray emission. The X-ray protection area should consist of a wall, floor and ceiling with a minimum of 1.5 mm lead shielding or its equivalent and should have glass windows with a minimum of 1.5 mm lead shielding or its equivalent, through which the operator can observe the patient. A sign should clearly identify the area as an X-ray protection area, and a caution sign should light up during X-ray emission. Observe local regulations.
- The user must restrict access to the equipment in accordance with local regulations for radiation protection.
- The patient must be provided with appropriate X-ray protection gear such as lead-impregnated clothing that conforms to local regulations.
- Proper infection control procedures must be established and maintained for each patient.
- It is strongly suggested that no unauthorized personnel be in the immediate area when the equipment is in use.
- This unit is not designed for and must not be used for “fluoroscopic examinations”.
- Proper radiation safety precautions must be established in accordance with local, state and governmental regulations in regards to operator and patient protection. The ultimate responsibility lies with the owner/operator to ensure that the protection requirements of national and local codes are met.
- When an examination requires X-ray irradiation to implantable or wearable electronic medical device, the operator must take proper care after referring to the operation manual (and related safety information) for such implantable or wearable electronic medical devices because if a diagnostic X-ray device directly irradiates an implantable or wearable electronic medical device, it can cause sufficient electronic interference to affect the function and operation of the medical device.
 - * For reference, U.S.A. FDA published about interference with cardiac implantable electronic devices (pacemakers and implantable cardioverter defibrillators), insulin pumps, and neurostimulators on the following web site. (Accessed July 2018)
Title: Interference between CT and Electronic Medical Devices
URL: <https://www.fda.gov/Radiation-EmittingProducts/RadiationSafety/ElectromagneticCompatibilityEMC/ucm489704.htm>
- Judgment and caution should be used in regards to radiographs of pregnant women. The decision should be based on “clinical need of diagnostic information”.
- The operator must be able to see the CT conditions of operation displayed on the Arm control panel prior to the emission.
- The operator must be able to see the exposure emissions lights and hear the audible signal during operation of the equipment.
- The operator must be able to see and hear the patient during the operation of the equipment.

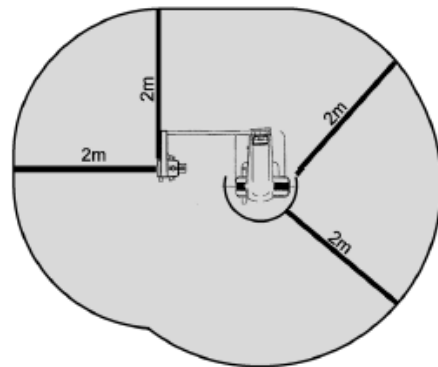

WARNING

- *Responsible organization in medical institution needs for providing means for audio and visual communication between the operator and the patient.*
- *Watch the area around the moving parts to avoid collision against the body parts or other objects which may result in injury.*
- *The EQUIPMENT should not be used adjacent to or stacked with other equipment and that if adjacent or stacked use is necessary, the EQUIPMENT should be observed to verify normal operation in the configuration in which it will be used.*
- *Do not fail to turn the unit off after use; this will eliminate the risk of electrical leakage and accidents.*
- *The main switch should be turned off during standard maintenance procedures. It is also recommended that the main breaker or fuse on the main electrical distribution panel be turned off as some electricity reaches the main power terminal inside the unit even when the main switch is off.*
- *Do not use this equipment for patients when it is being maintained or serviced.*
- *Use special care to explain to the patient proper instructions as to when they can move as there are “multiple movements” with certain exposures.*
- *Do not press the panel too hard not to damage the panel.*
- *It may not be possible to make a diagnostically useful exposure if the patient has metal fillings or prosthetic devices.*
- *Make sufficient space around the Main Switch so that it is easily accessible in case of emergency.*
- *Make sufficient space around the Power Plug so that it is easily unplugged in case of emergency. (For EX-1)*
- *Make sufficient space around the Power distribution panel so that it is easily to breaker open in case of emergency. (For EX-2)*
- *To avoid the risk of electric shock, this equipment must only be connected to the supply mains with protective earth.*
- *To avoid the risk of electric shock, do not replace the power supply cord.*
- *Do not touch simultaneously the patient and the conductive parts, such as the connector terminals.*

CAUTION

- *This equipment does not provide CT Numbers (required in 21 CFR 1020.33 and IEC60601-2-44) or any equivalent values calculated from the absolute X-ray absorption of the target material*
- *The X-ray images could be affected by either constant or intermittent environmental electromagnetic noise. This could cause image distortions or shifts that could render the obtained images useless for diagnosis.*
- *Quality Tests should be performed regularly once every six months (once a month recommended) to maintain the conditions for adequate image performance and X-ray safety of the equipment. The test procedure is described in the Quality Tests Procedure manual that will be provided with the equipment. Other basic functions such as mechanical movements, LCD panel display and Control Panel keys should also be checked each day before use.*

Parts Identification

1. Parts Identification

Main Unit

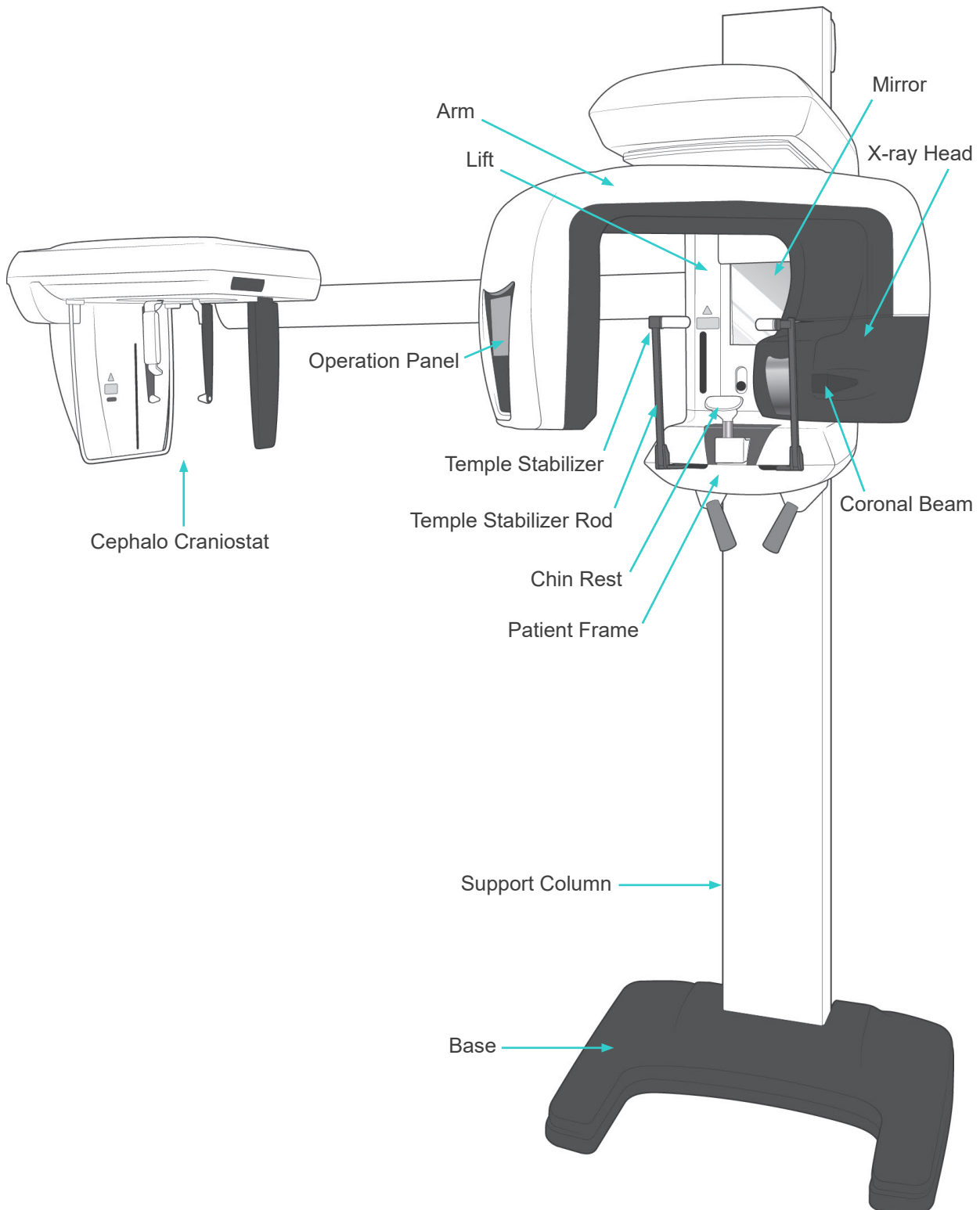

Control Box

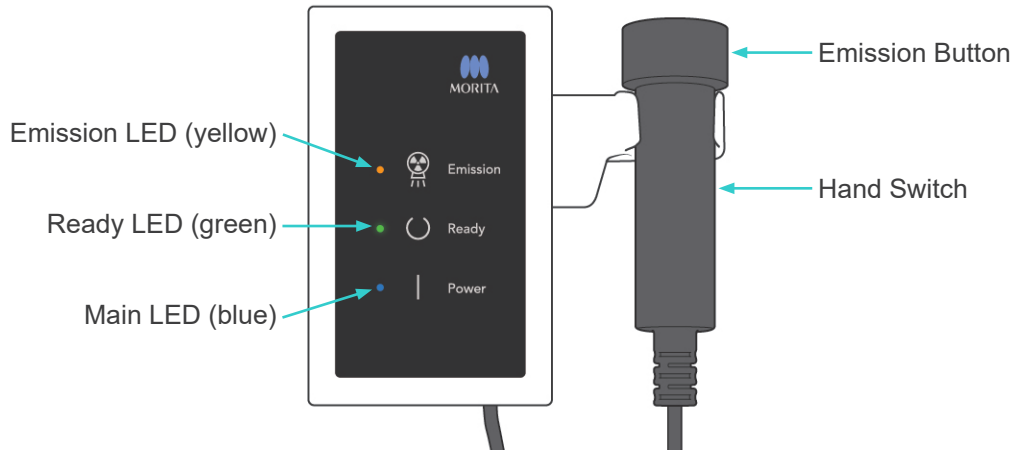

Patient Frame

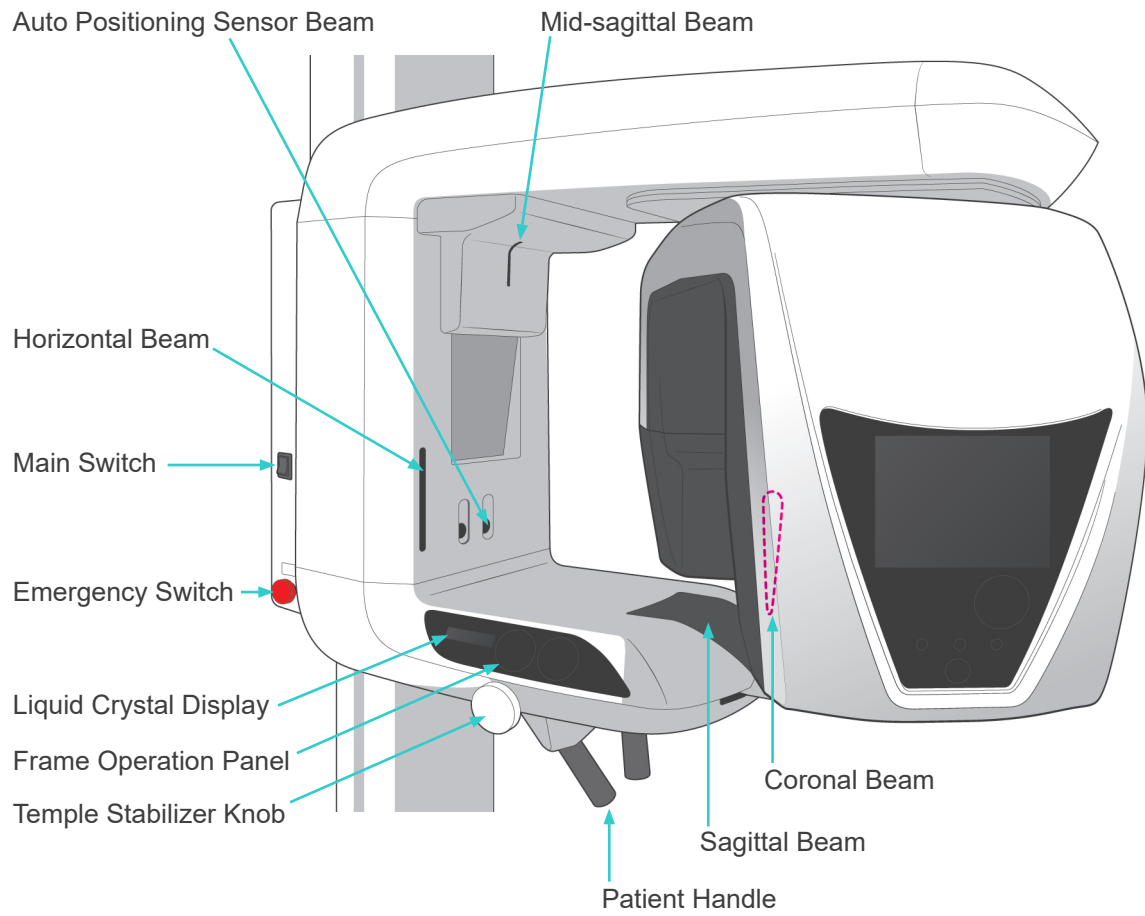

Cephalo Unit (option)

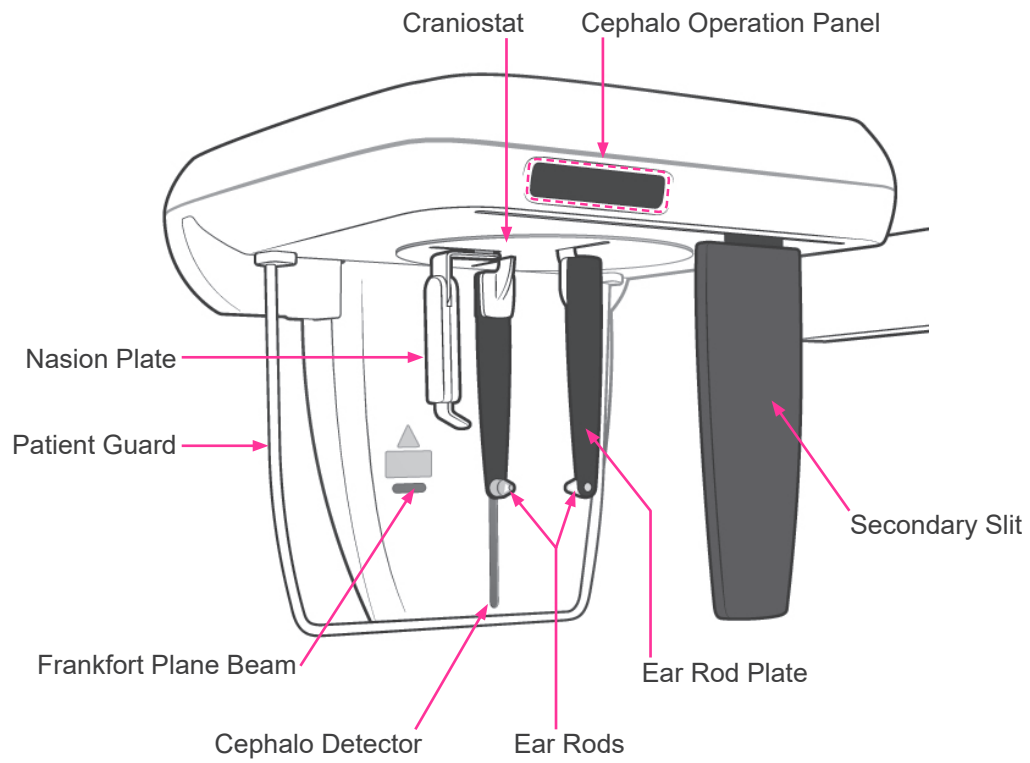

2. Patient Frame and Arm Operation Panels

(1) Patient Frame Panel

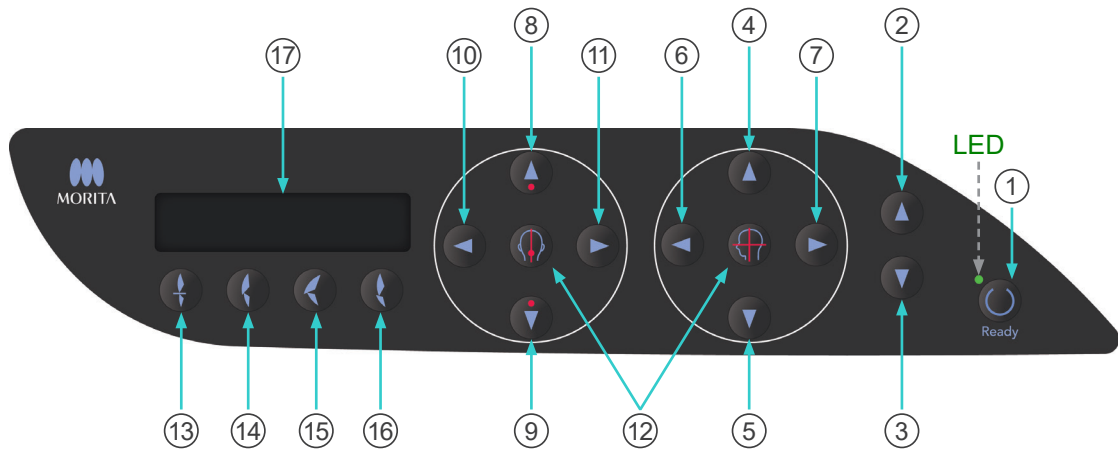

① Ready Key

Press the Ready key when its LED (green) is blinking. The arm will move into position and the LED will stop blinking and stay on. After the exposure is completed, the key will start blinking again.

② Lift Up Key

③ Lift Down Key

The lift goes up or down only while these keys are held down.

④ Horizontal Beam Up Key

⑤ Horizontal Beam Down Key

Hold these keys down to lower or raise the Horizontal beam. For panorama, line this beam up with the patient's Frankfort plane. For CT exposures, line it up with the center of the exposure region.

⑥ Coronal Beam Forward Key

⑦ Coronal Beam Backward Key

Hold these keys down when unit is in Ready mode to move the beam backwards or forwards. For panorama, line this beam up with the distal side of the upper, left canine.

For 40×40 and 40×80 CT exposures, line it up with the center of the exposure region as viewed from the side.

For 80×50, 80×80, 100×50 and 100×80 CT exposures, line it up with the distal side of the upper, left canine.

- ⑧ Auto Positioning Sensor (AF) Up Key
- ⑨ Auto Positioning Sensor (AF) Down Key
Hold these keys down to raise or lower the sensor. Line it up so that the sensor beam strikes the mouthpiece in the patient's mouth or the patient's incisors.
- ⑩ Sagittal Beam Right Key
- ⑪ Sagittal Beam Left Key
Hold these keys down to move the beam to the right or left. For CT images or the two-direction scout image, line this beam up with the center of the exposure region.
- ⑫ Beam On and Off Keys
Positioning beams automatically go off after 3 minutes. Press these keys to turn them back on. Or press them to turn the beams off.
- ⑬ Incisal Occlusion Key
This key is used to make a panorama exposure for a patient with standard occlusion biting on a mouthpiece. After adjusting the height of the positioning (AF) sensor, press this key to automatically move the arm backwards or forwards to the optimum position.
- ⑭ Natural Occlusion Key
This key is used to make a panorama exposure for a patient with standard occlusion without using a mouthpiece. After adjusting the height of the positioning (AF) sensor, press this key to automatically move the arm backwards or forwards to the optimum position.
- ⑮ Protruding Maxillary Occlusion Key
This key is used to make a panorama exposure for a patient with protruding maxillary without using a mouthpiece. After adjusting the height of the positioning (AF) sensor, press this key to automatically move the arm to the optimum position.
- ⑯ Protruding Mandibular Occlusion Key
This key is used to make a panorama exposure for a patient with protruding mandible without using a mouthpiece. After adjusting the height of the positioning (AF) sensor, press this key to automatically move the arm to the optimum position.
- ⑰ Frame Liquid Crystal Display (LCD)
Displays various information including coronal beam position, exposure mode, exposure conditions, etc.

(2) Arm Operation Panel

Usage Note

- ◆ Do not press down with excessive force on either of the operation panels. Do not press on the panels with any sharp objects like ballpoint pens or fingernails etc.

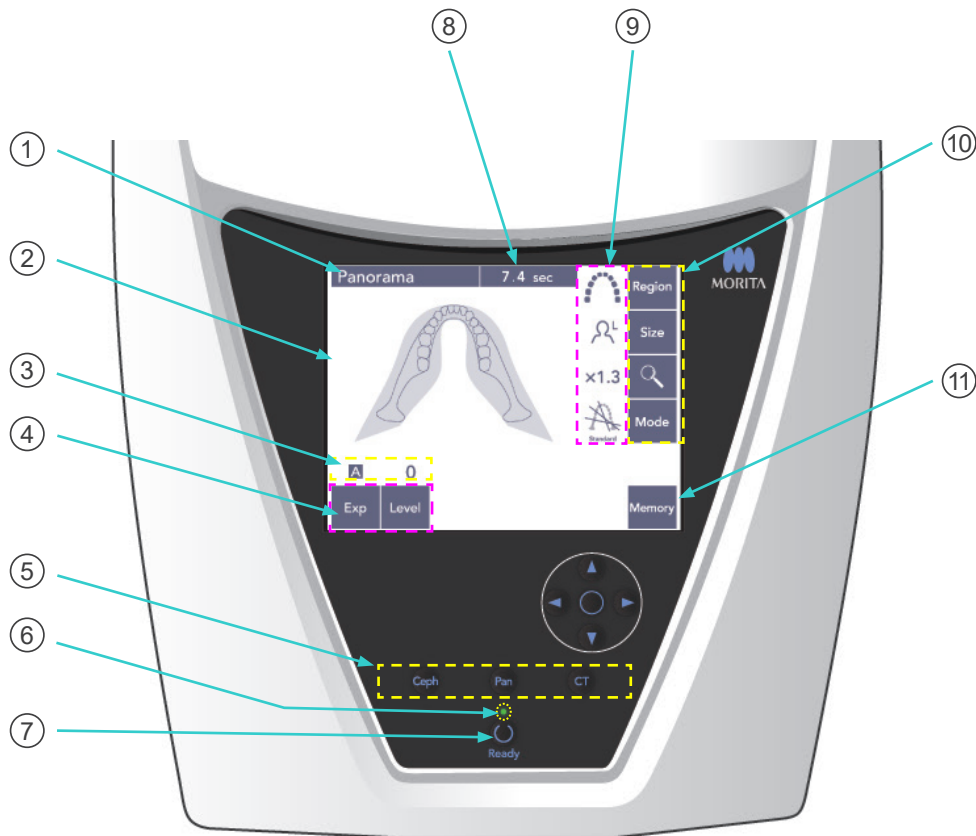

① Title Bar

This shows the current mode setting, panorama, cephalo, or CT.

② Arm Operation Panel Display

This is a touch panel. Press on keys in the display with your finger to make various settings. The color of a key changes to white when it is pressed. Various types of information and error messages also appear in this display.

③ Exposure Conditions Display

Shows the tube voltage (kV) and current (mA) settings or the Auto Level setting.

④ Exposure Conditions Keys

Use these keys to select and set conditions for auto or manual exposure and the auto level.
For an Auto exposure, set the Auto Level.

For a Manual exposure, set the tube kV and mA.

Press the Level, kV or mA key to set its value with the Up and Down keys that will appear.

After changing the value with the Up or Down key, press the key (Level, kV, or mA) again to set it.

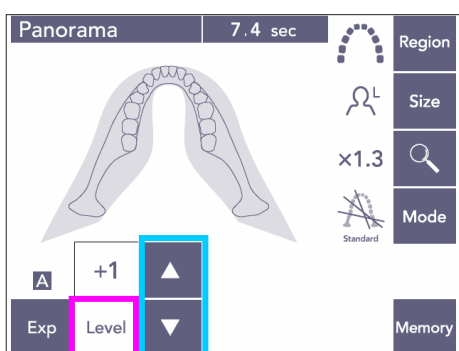
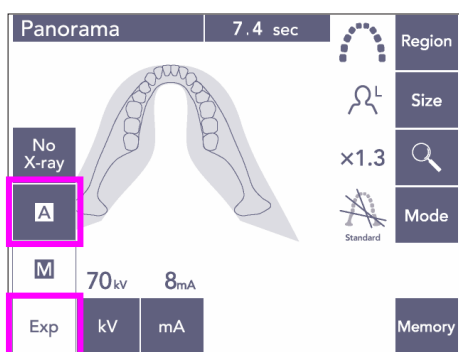

⑤ Exposure Mode Keys

Press these to select panorama, cephalo or CT exposure mode.

⑥ Ready LED

⑦ Ready Key

When the power is turned on, the LED for the Ready key blinks on and off. Once the patient is standing in position, press the Ready key. The arm moves to the initial patient positioning position, and the LED for the key will stop blinking and stay on. After completing patient positioning, press the Ready key again; the arm will go to its Start position. This called the Double-Ready*¹ set up.

*¹ The Double-Ready function is not enabled by default. To enable the Double-Ready function, contact your local dealer or J. MORITA OFFICE.

⑧ Exposure Time Display

Shows the anticipated exposure time before the exposure and the actual time after the exposure.

⑨ Exposure Settings Display

Shows the current settings for the selected exposure mode.

⑩ Exposure Settings Keys

Use these keys to make settings for the currently selected exposure mode, panorama, cephalo, or CT. The keys that appear here will differ depending on the selected exposure mode.

Press one of the keys to display the possible settings and then select one of them.

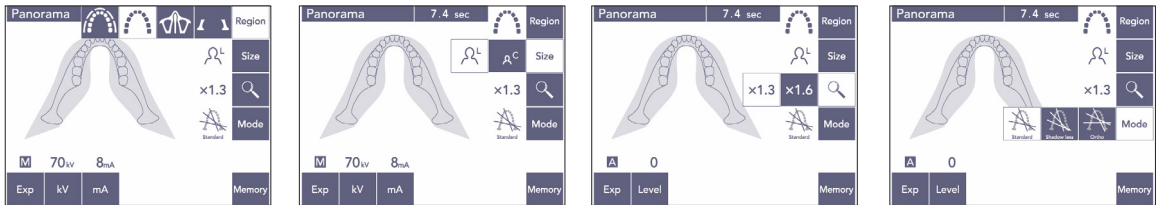

⑪ Memory Key

Press this key to bring up the dialogue box shown below.

Press Yes to memorize the current settings (tube voltage and current, auto level, and exposure region).

Press Reset to restore the default settings.

Press No to cancel the operation.

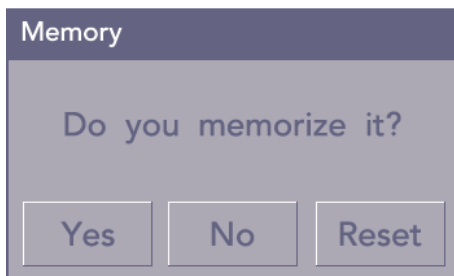

(3) Cephalo Operation Panel (option)

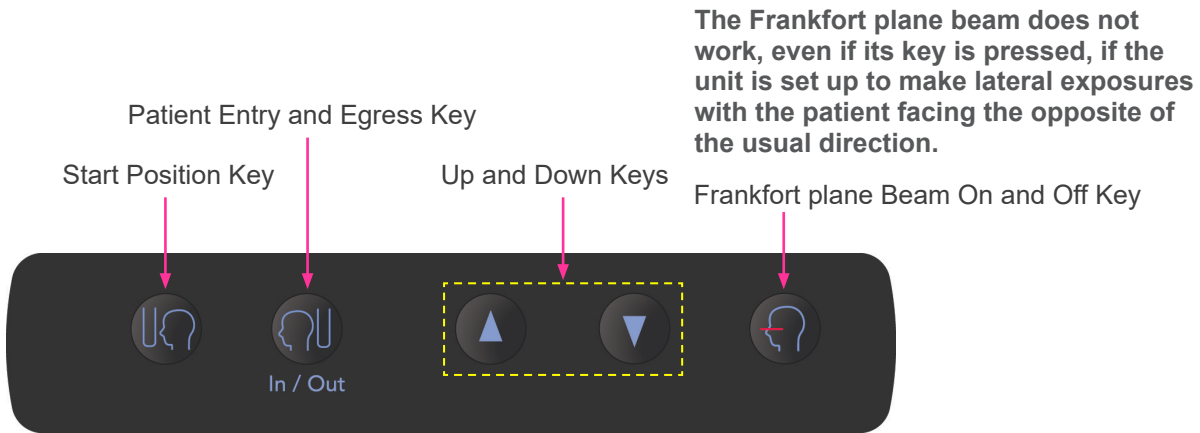

3. Patient Positioning Tools and Consumable Parts

- Mouthpieces (1 box of 50)
- Chin Rest (1)
- Lip-nose Rest (1)
- Bite Block (1)
- Bite Plate (1)
- Bite Block Covers (1 box of 300)
- Ear Rods (2, optional)
- Hand X-ray Plate (1, optional)

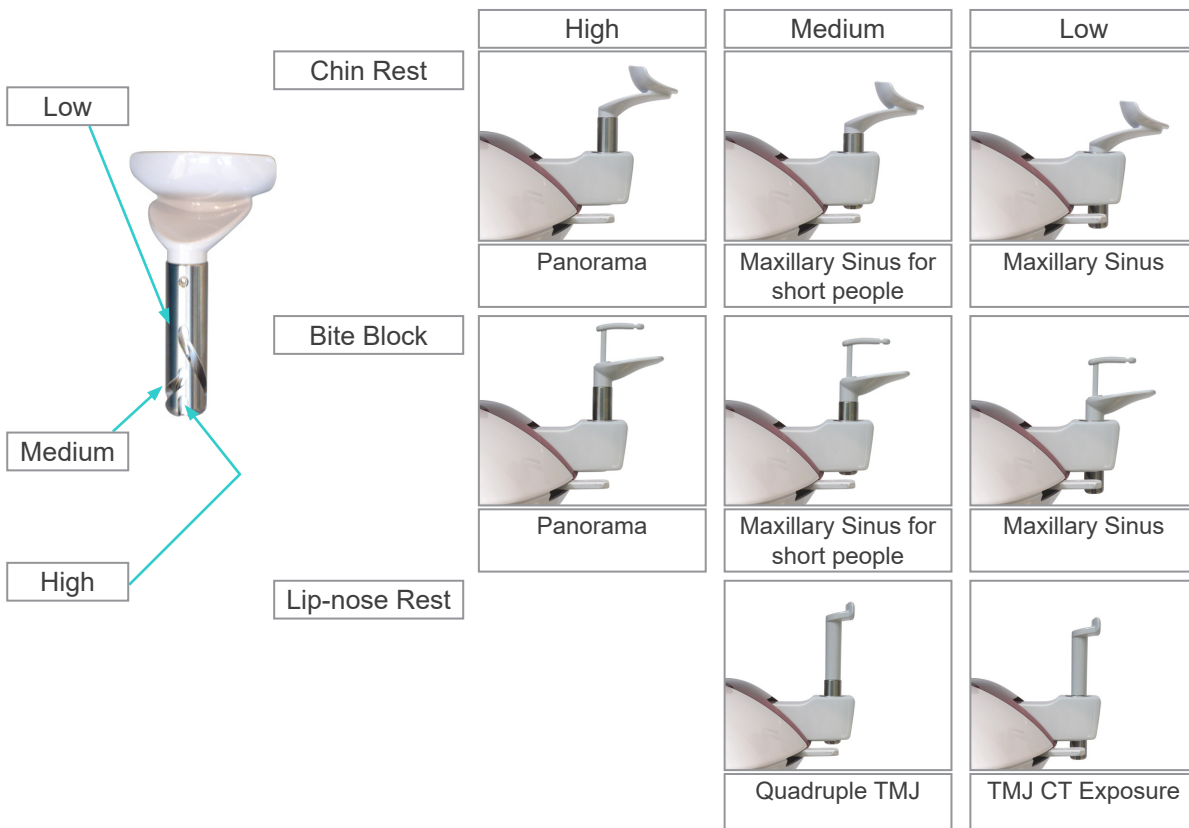

Operation

i. Preliminary Procedures

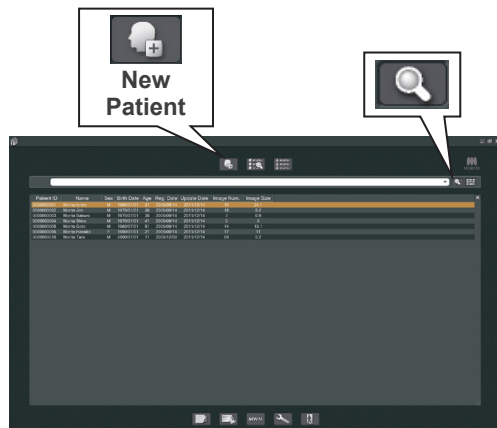

- * If an accident occurs, the equipment must not be used until repairs have been completed by a qualified and trained technician provided by the manufacturer.
- * Have patients remove glasses, necklaces, earrings and other accessories which could interfere with diagnosis.
- * If the unit has not been used for some time, make sure it operates normally and safely before actually using it.

Turn on the computer and start up the i-Dixel application. Then bring up the patient list.

- * Simply click the magnifying glass symbol at the end of the search field to bring up the complete list of patients.

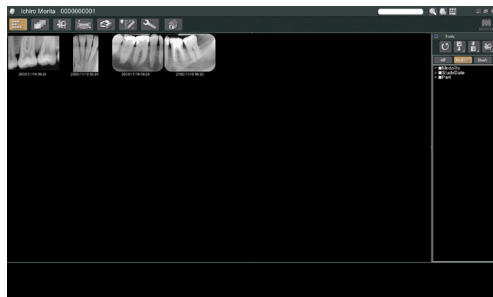

Select the patient for whom you will make an exposure and display his image list. (For new patients, click the New Patient button, register the patient and then display the image list page.)

Make the exposure while the image list page is being displayed.

- * For details refer to the user manual for the i-Dixel application.
- * Resolution for CT exposures is set automatically and cannot be changed.

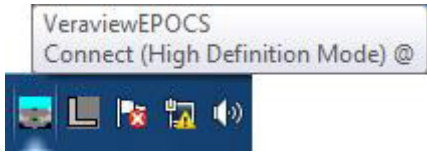

(1) Check Resolution

Place the mouse cursor on the resolution icon on the task bar at the bottom of the screen.

Resolution Icon: 

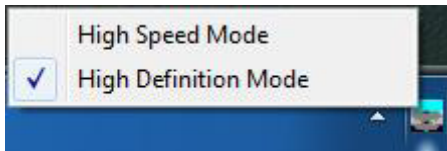

(2) Change Resolution

Click the Resolution Icon on the task bar at the bottom of the screen.

The current setting (High Speed or High Definition) will be checked. Click the other setting to change to it.

- * For 40P and 40CP models, only High Speed is available.

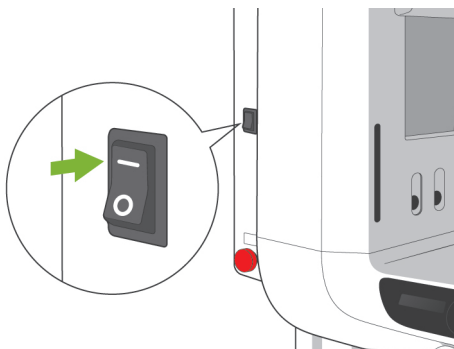

(3) Check Panorama Operation

Turn main switch on.
Press the Ready key to enable X-ray emission. Hold down the emission button and check that the arm rotates, X-rays are emitted, the X-ray emission LED lights up, and the audible signal sounds. Also check that after the emission time has elapsed, X-ray emission stops and the arm stops rotating. Press the emission button again to return the arm to its patient entry position.



(4) Check Cephalo Operation

Turn main switch on.
Press the Ceph key on the main operation panel. Completely close the temple stabilizers by turning the Temple Stabilizer Knob.
Press the Ready key to move the X-ray head and the arm into their Cephalo positions. Check that the Ready LED on the Arm Operation Panel and the control box is on. Press the Start Position key  on the cephalo operation panel to move the unit to its start position. Hold down the emission button and check that X-rays are emitted, the X-ray emission LED lights up, and the audible signal sounds. Also check that after the emission time has elapsed, X-ray emission stops, the emission LED goes out, and the audible signals stops.



(5) Check CT Operation

Turn main switch on.

Press the CT key on the main operation panel.

Press the Ready key to complete getting ready.

Then hold the emission button down. Check that the arm rotates, X-rays are emitted, the X-ray emission LED lights up, and the audible signal sounds. Also check that after the emission time has elapsed, X-ray emission stops and the arm stops rotating.

Press the emission button again to return the arm to its patient entry position.

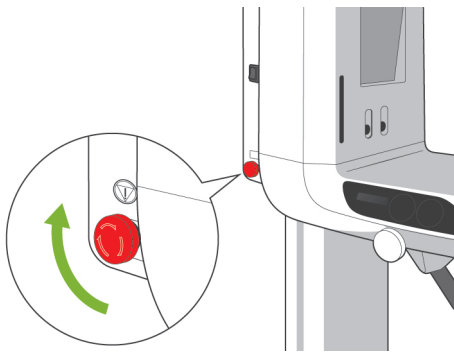

Usage Note

- ◆ *The unit cannot be turned on if the Emergency Stop switch has been accidentally pressed during cleaning etc. Turn the switch in the direction indicated by the arrow to release it.*

ii. Operation Procedures

1. Safety Check

For safety, keep fingers away from moving parts when they are moving.

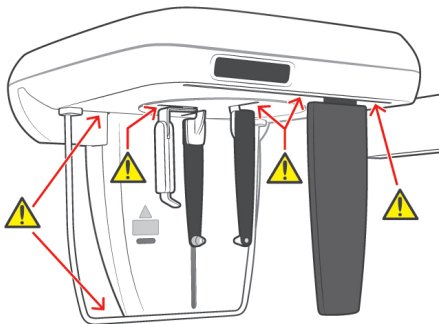
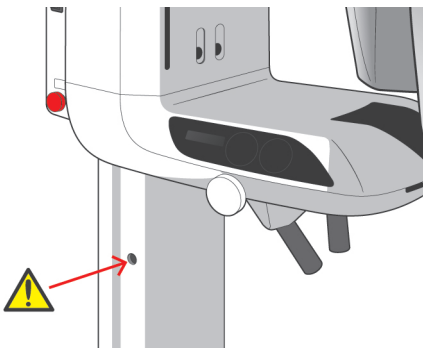
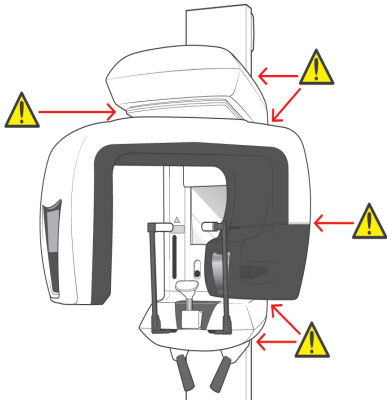

CAUTION

- *Keep fingers away from gaps and openings for moving parts such as the temple stabilizers as well as the holes on the support column for threaded bolts.*

2. Panorama Exposures

(1) Turn main switch on.

Press the top (|) of the main switch. The blue main LED on the control box will light up to show that the unit is on.

The title bar on the display on the arm will read "Panorama."

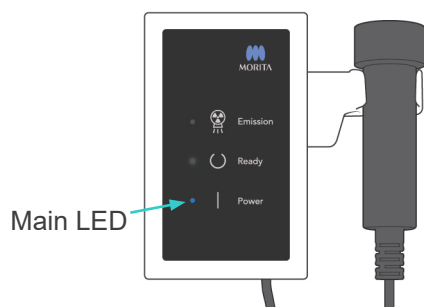
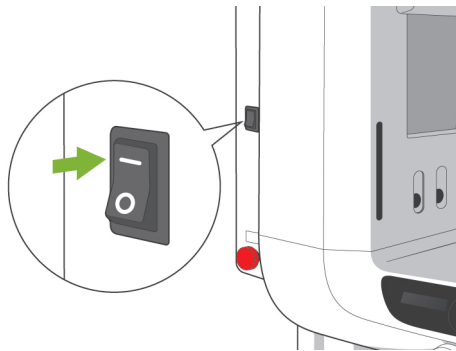

⚠ CAUTION

- Do not turn the main switch on if the patient is standing near the unit. The arm will move and it could hit the patient.

(2) Emergency Switch

In case of an emergency, press the Emergency Stop Switch. This will stop the arm's rotation, lift movement and X-ray emission. Use this switch only for emergencies.

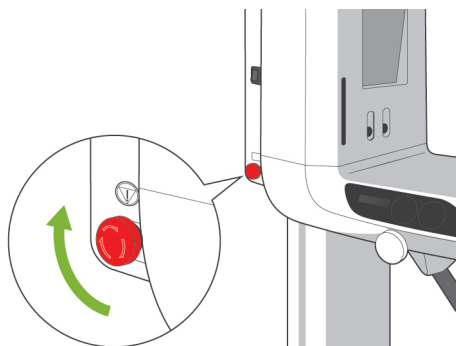
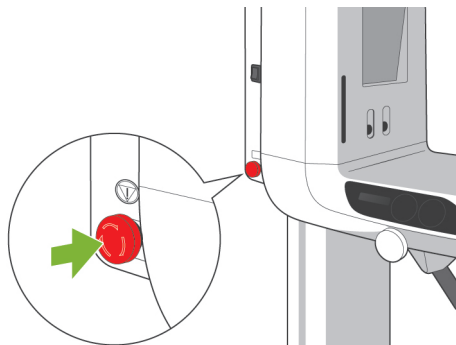

After Pressing the Emergency Switch

Guide the patient away from the unit and turn the main switch off. This will return the unit to a safe condition.

Turn the switch in the direction indicated by the arrow and restart the computer. Then turn the main unit back on and check that it is set for Panorama Exposure. If the unit cannot be returned to a safe condition or will not operate, contact your local dealer or J. MORITA OFFICE.

⚠ CAUTION

- The image will be lost if the Emergency Stop Switch is pressed during its transmission or if the main switch is turned off.

(3) Panorama Settings

When the unit is turned on, the operation panel is set to the factory defaults shown in the photo to the left.

* See page 38 for a more detailed explanation about the exposure settings.

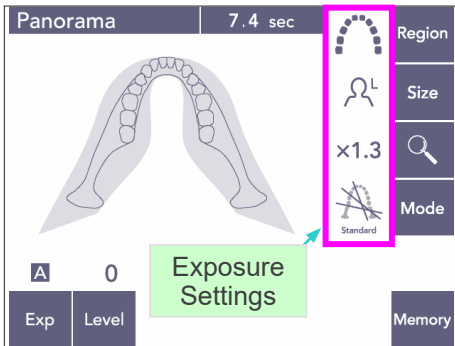

(3)-1 Auto Exposure (Digital Direct Auto Exposure)

Auto exposure regulates tube kV and mA for each individual patient.

Press the Exp key and then the A key.

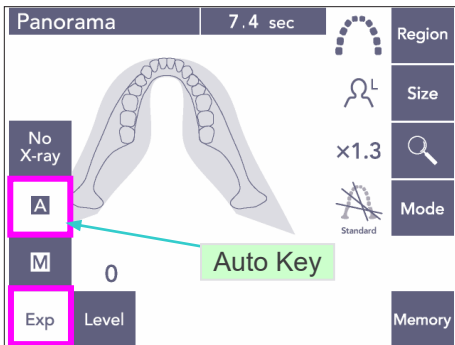

Press the Level key and then use the Up or Down key to set the Auto Level. There are nine auto levels for +4 to -4.

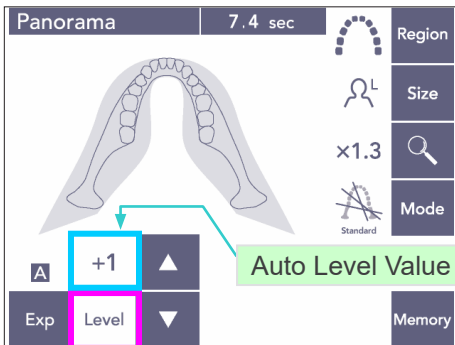

Chart 1

Auto Level	X-ray Output Ratio
+4	207%
+3	173%
+2	144%
+1	120%
0	100%
-1	83%
-2	69%
-3	58%
-4	48%

Chart 1 shows the relative X-ray output for each auto level. Increasing the auto level value will increase density and contrast and is good for hard tissue.

* The factory setting for the Auto Level is 0.

(3)-2 Manual Exposure

Press the Exp key and then the M key.

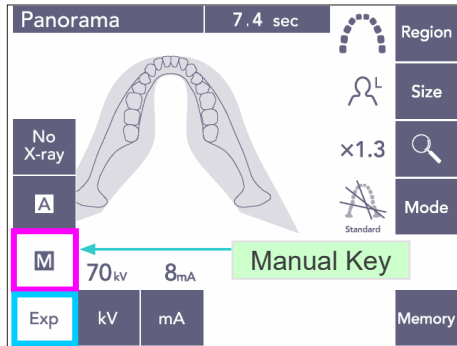

Press the kV key and then use the Up or Down key to set the kV value.

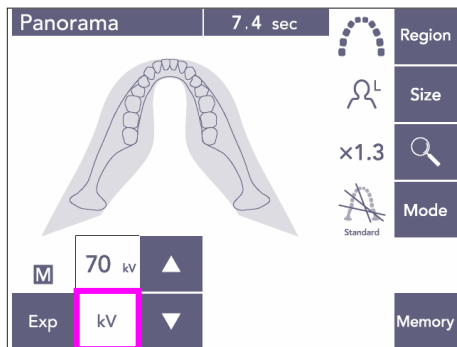

Press the mA key and then use the Up or Down key to set the mA value.

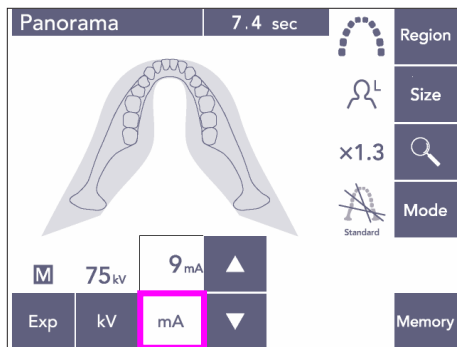

kV can be set from 60 to 80 kV in increments of 1 kV, and mA from 1 to 10 mA in increments of 1 mA. The factory settings are 70 kV and 8 mA.

(3)-3 No X-ray Setting

This function is prepared to simulate an actual scan without X-ray emission. Use it to check the arm rotation orbit, to explain the movement of the device to the patient or to ensure the arm will not hit the patient during a scan.

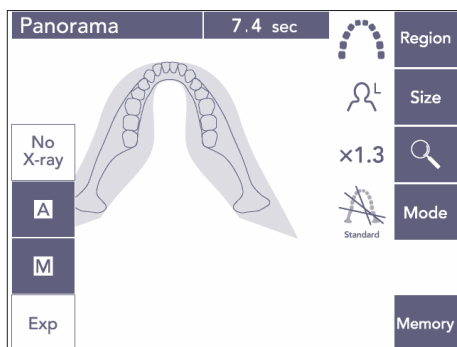



Ready LED

Ready Key

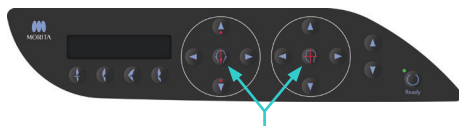

Beam On and Off Keys

(4) Patient Positioning

Press the Ready key. The arm will automatically move into position for patient positioning. The green Ready LED will stop blinking and stay on. The horizontal, mid-sagittal, coronal and AF beams will light up.

Usage Note

- ◆ Before pressing the Ready key, make sure the temple stabilizers are closed all the way. Otherwise, the arm might hit them and damage them.

The beams go off automatically after 3 minutes. Press either one of the beam on and off keys to turn them back on again.

- * The coronal beam will not light up if the Ready key has not been pressed.

⚠ WARNING

- The laser beams could damage the eyes. Do not stare into the positioning beams. Warn the patient not to look at the positioning beams.

⚠ CAUTION

- Have patients remove glasses, earrings and any other accessories that might interfere with making a good exposure.
- Keep fingers away from gaps and openings for moving parts such as the temple stabilizers as well as the holes on the support column.
- Do not let patients touch the switches on the Frame Operation Panel.
- Take care that the patient's hair does not get caught in the moving parts. Undo pony tails so that the arm will not hit them.

High	Medium	Low
Dental Arch Panorama	Maxillary Sinus for short people	Maxillary Sinus

- 1) Put the chin rest in its holder. Use the High position for dental arch panorama exposures; use the Medium or Low positions for maxillary sinus panorama exposures. (See page 16, 3. Patient Positioning Tools and Consumable Parts, and page 43, Chin Rest Position.)

Line up the center of the mouthpiece with the center of the upper and lower incisors.

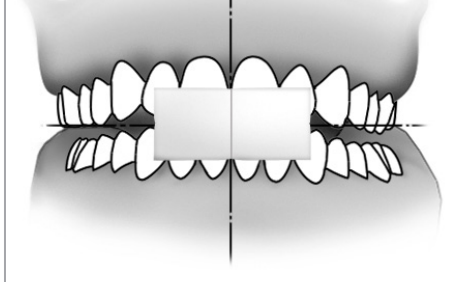

2) Initial Patient Positioning

Put an X-ray protection apron with thyroid collar on the patient. Have the patient perform the incisal occlusion while biting on an unused mouthpiece.

Line up the center of the mouthpiece with the center of the upper and lower incisors. Have the patient stand in front of the chin rest. Look at him from the side, and have him pull in his chin and straighten his back. Then look from behind and make sure his shoulders and back are straight.

WARNING

- *A new, uncontaminated mouthpiece must be used for each patient to prevent cross-contamination.*

CAUTION

- *Use only the specified mouthpieces.*

- * Keep mouthpieces in a clean, uncontaminated area.

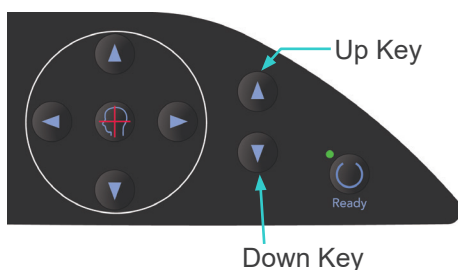
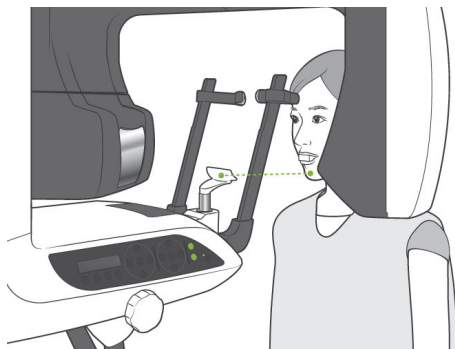

3) Use the Lift Up or Down Key to raise or lower the chin rest and line it up with the patient's chin. Release the key when the chin rest is at the right height.

The Lift starts moving slowly (Slow Start). It will stop automatically if there is an excessive load on it.

Usage Note

- ◆ *Always use the Up and Down Keys to move the Lift. Never try to force it; this would damage it.*
- ◆ *An excessive load will activate the protection circuit. The lift will stop and an audible signal will sound. "Lift Overload" will appear in the frame's display for about 2 seconds and then disappear.*

⚠ WARNING

- Take care that the temple stabilizers do not strike the patient in the eye.

⚠ CAUTION

- Do not use excessive force to close the temple stabilizers. This could be uncomfortable for the patient or damage the stabilizers.
- Forcing the patient in or out could also damage the stabilizers.

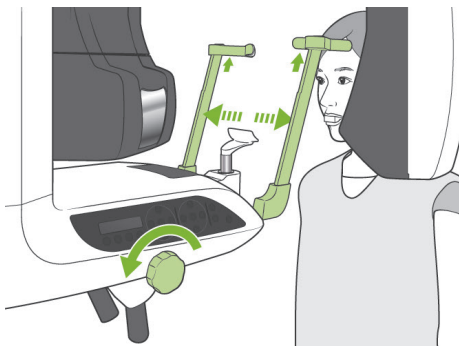

- 4) Use the knob to open the temple stabilizers. Have the patient move forward without slouching or otherwise changing his posture. Then have him put his chin on the chin rest and lightly grip the patient handles. Make sure his shoulders are lowered.

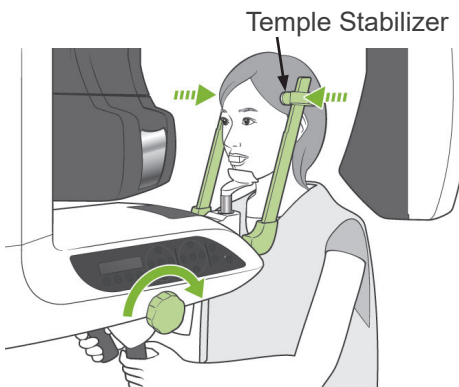

- 5) Close the temple stabilizers until they lightly touch the patient's temples.

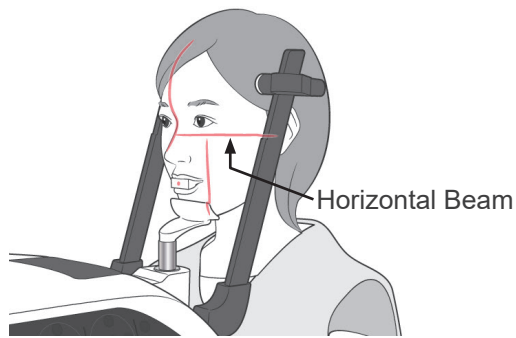

- 6) Make sure the patient's face is straight and then line up the horizontal beam with the patient's frankfort plane using the beam Up or Down key.

⚠ WARNING

- *The laser beams could damage the eyes. Do not stare into the positioning beams. Warn the patient not to look at the positioning beams.*

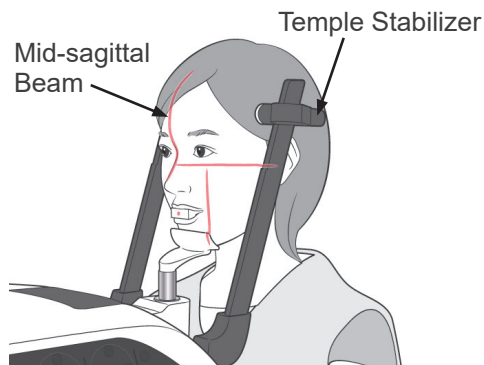

- 7) Move the patient's head to the left or right until the Mid-sagittal beam lines up with the patient's mid-sagittal plane. Then tighten up the temple stabilizers so that the patient's face will not move.

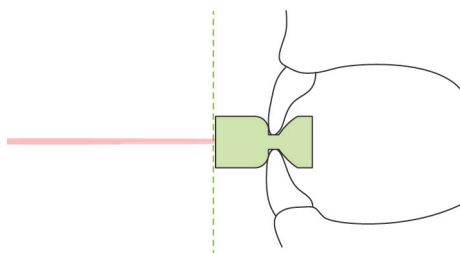

- 8)-1 Auto Positioning
Use the Auto Positioning (AF) Sensor Up and Down Keys to line the sensor beam (red) with the center of the mouthpiece.

Usage Note

- ◆ *Make sure the mouthpiece is perpendicular and the beam strikes the center of it. If the beam is off center, the image layer will not be properly detected and the image could be spoiled.*
- ◆ *Condensation on the lens for the AF sensor beam could prevent proper detection of the image layer. Use a soft cloth to wipe condensation off the lens.*

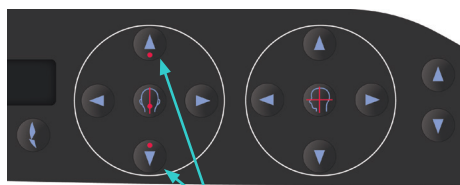

AF Sensor Beam Up and Down Keys

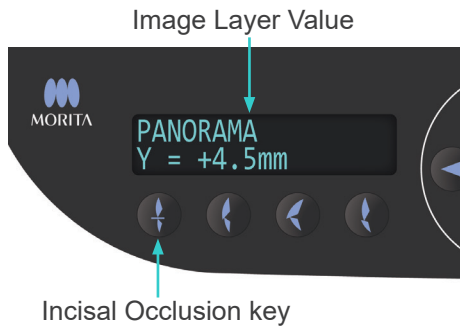



Press the Incisal Occlusion Key, which is used for auto positioning with the mouthpiece.

The arm (and the coronal beams) will move to line the image layer up with the patient, and the value of the image layer will be displayed. Check that the coronal beam is lined up with the distal side of the upper left canine.

There are three types of auto positioning that do not use the mouthpiece.

For these, the AF sensor beam is lined up with the center of the upper incisors.

- * For natural occlusion, press the Natural Occlusion Key .
- * For a protruding maxillary, press the Protruding Maxillary Key .
- * For a protruding mandible, press the Protruding Mandible Key .

In each case, the arm will move to match the image layer with the patient's dentition and the image layer value will be displayed.

Usage Note

- ◆ *If the mouthpiece is not used, the AF sensor beam may not detect the correct image layer position for edentulous patients, patients with twisted upper incisors, or patients with lustrous crowns or full orthodontic bands. In these cases, use Manual Positioning.*

- * If a patient is not standing in place or is out of the range for the arm's back and forth movement (+20 mm to -20 mm), beeping will indicate an error when an occlusion key is pressed. "Out of Range" will appear in the frame's display for about 2 seconds and then disappear.

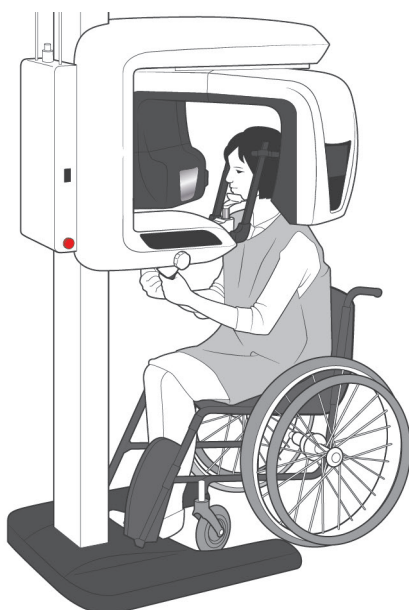
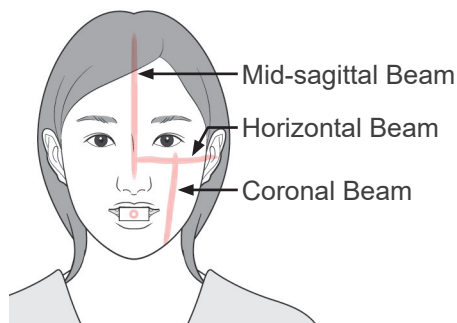
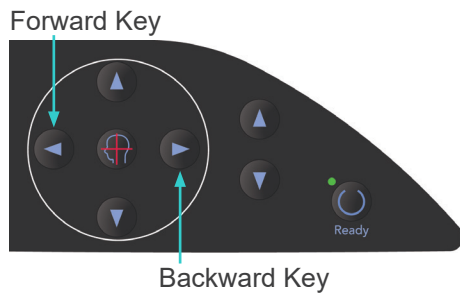
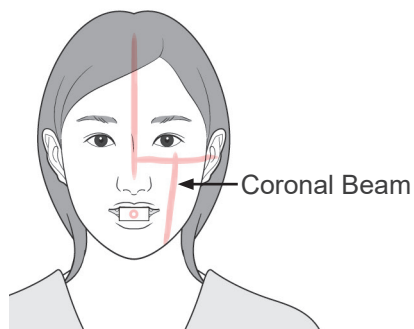

8)-2 Manual Positioning

Use the Backward and Forward Keys to line the Coronal Beam up with the distal side of the patient's upper, left canine.

⚠ WARNING

- *The laser beams could damage the eyes. Do not stare into the positioning beams. Warn the patient not to look at the positioning beams.*

- * Depending on the shape of the patient's face, the Coronal Beam may not directly strike the distal side of the upper left canine. In this case, position the beam so that an imaginary extension of it is lined up properly.

The beam's movement range is normally from +20 mm to -20 mm, but it is less for some projections.

Make sure the horizontal, mid-sagittal and coronal beams are lined up properly.

⚠ CAUTION

- *Warn the patient not to move during the X-ray exposure (while the melody is playing). If the patient moves, he could be hit by the arm or the exposure could be a failure.*

The base is shaped to accommodate a wheel chair as shown in the illustration to the left.

- * However, wheel chairs with a width greater than 480 mm will not fit.

Usage Note

- ◆ If the patient is not properly positioned the image may not be useful for diagnosis. Refer to the examples below to better understand proper patient positioning.

8)-3 Examples of Patient Positioning and Image Results

Accurate Positioning

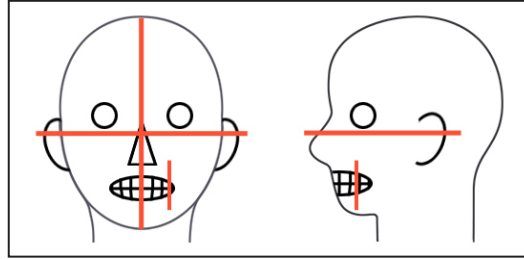

Patient Looking Down

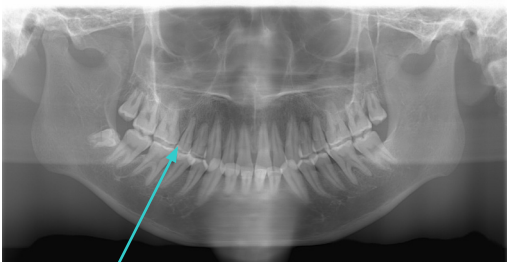

V-shaped Dental Arch

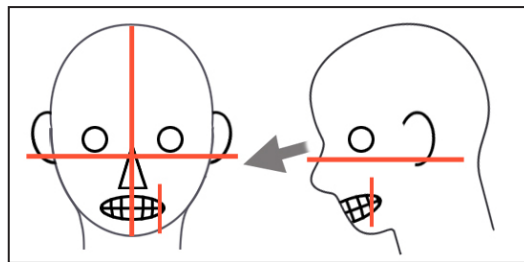

Patient Looking Up

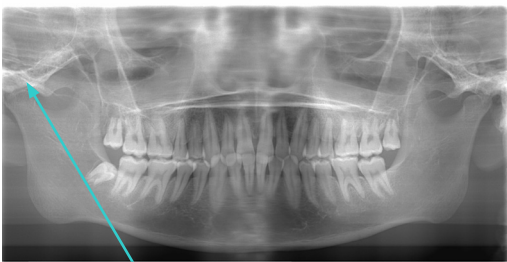

Joint is Out of Picture

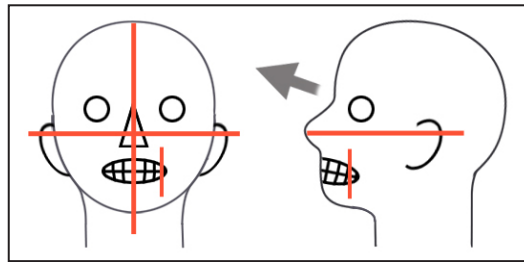

Patient Looking to the right

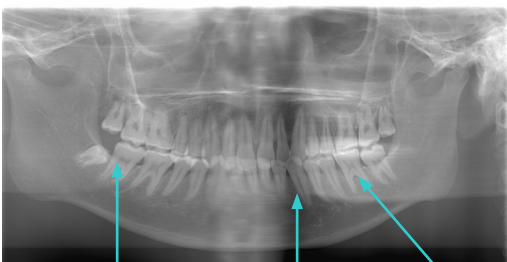

Enlarged

Reduced

Reduced X-ray absorption here (Excessive saturation)

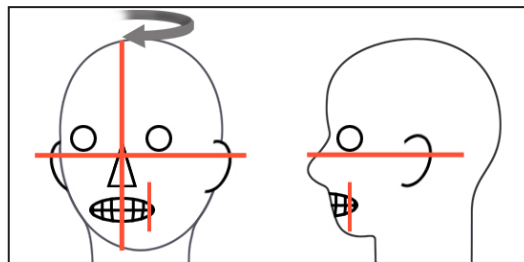

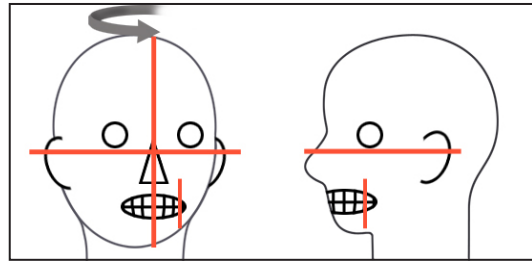
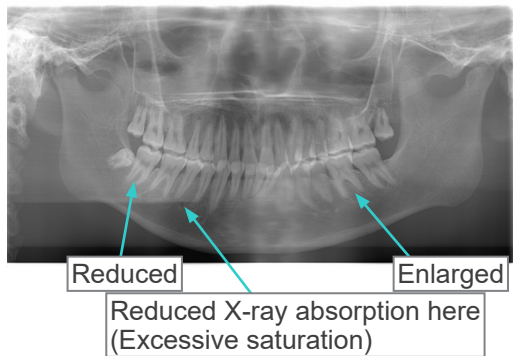
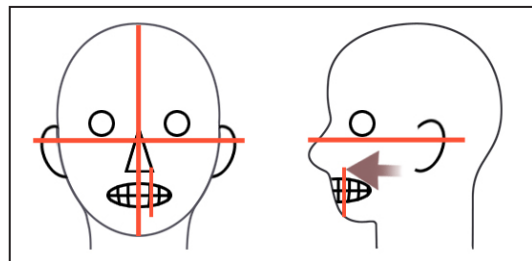
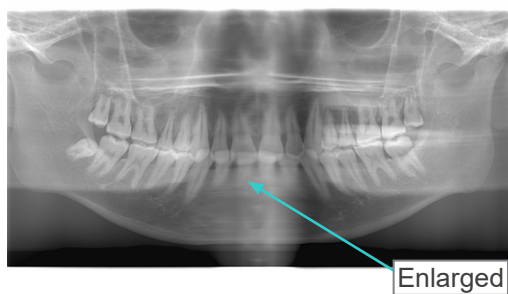
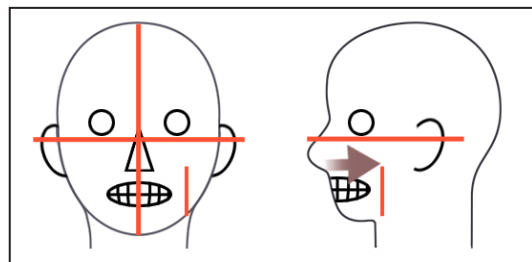
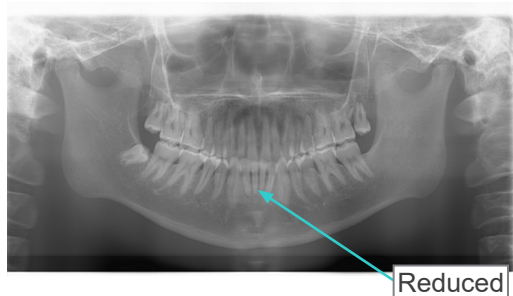
Patient Looking to the left**Image-layer Beam too far forward****Image-layer Beam too far back****9) Double-Ready*¹ Function**

*¹ The Double-Ready function is not enabled by default. To enable the Double-Ready function, contact your local dealer or J. MORITA OFFICE.

Press the Ready key a second time after completing patient positioning in Ready mode; a two-toned beep will sound and the arm will move to its exposure start position. The Ready LED will stay on but the Coronal beam will go out.

- In the Double-Ready*¹ mode, X-ray emission starts as soon as the emission button is pressed.
- In the Double-Ready*¹ mode, other operation keys and switches are disabled except for the Ready key and Lift keys.
- In the Double-Ready*¹ mode, press the Ready key again to return to the patient positioning Ready mode.

Usage Note

- ◆ If the patient moves out of position after the unit is set for Double-Ready*¹, press the Ready key again to return the unit to its normal Ready setting and re-position the patient.

(5) Panorama Exposure

- 1) Make sure the green Ready LED is on; check the arm, patient frame or control box.



Ready LED



Ready LED

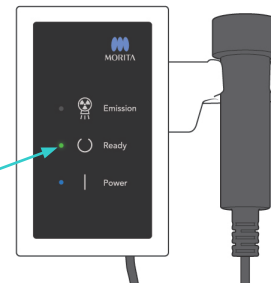

Ready LED

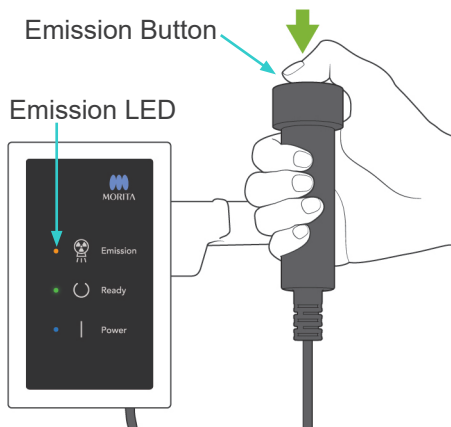

- 2) Pick up the handswitch and hold down the emission button. The arm will start to rotate and X-rays will be emitted. During X-ray emission, the yellow Emission LED on the control box will light up and an audible signal will sound.

Usage Note

- ◆ It could take up to 15 seconds for emission to begin after the emission button is pressed. This is because the computer is confirming the settings on the X-ray unit and is not a malfunction.
- ◆ If the computer is not ready, an error message will appear in the display on the arm. If this happens, turn off the main switch. When the computer is ready, turn the main switch back on.

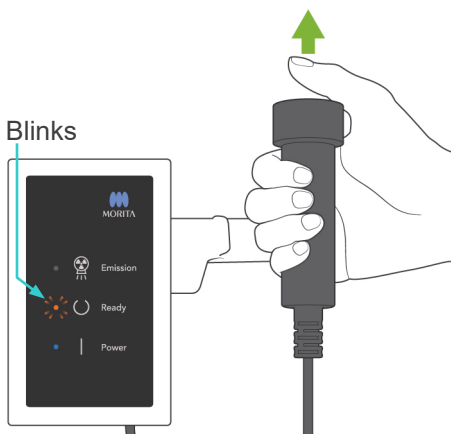

- 3) Keep holding the emission button down. X-ray emission and arm rotation will stop, the Emission LED will go out, and the audible signal will stop. Then the arm will go to its patient egress position. This completes the exposure procedure. Now release the emission button. The Ready LED will change to amber and start blinking and amber to show that the image is being transmitted. After transmission is completed, the Ready LEDs on the arm and control box will change back to green and blink on and off.

⚠ WARNING

- Always leave the X-ray booth, and press the emission button outside of it.
- In case of an emergency, release the emission button; this will completely stop the unit.
- If, for some reason, the operator must stay in the booth during X-ray emission, he should stay at least 2 meters away from the unit and wear an X-ray protection apron with thyroid collar. He should stay out of the X-ray beam.

⚠ CAUTION

- Warn the patient not to move during emission (while the melody is sounding). If the patient moves, he could be hit by the arm or the image might be ruined.
- Hold the emission button down until the exposure is completed. If you let go of the button during the exposure, the arm will stop and the exposure will be aborted. To make another exposure, first carefully guide the patient away from the X-ray unit and then return the apparatus to its patient entry position. If the X-ray head or the detector is in back of the patient, turn the unit off and then carefully rotate the arm manually before guiding the patient away from the unit. If you perform the Ready procedure before guiding the patient away from the unit, the arm could hit the patient and cause an injury.
- If an error occurs during emission, the arm will stop and the exposure will be aborted. Carefully guide the patient away from the unit. If the X-ray head or the detector is in back of the patient, turn the unit off and then carefully rotate the arm manually before guiding the patient away from the unit. If you perform the Ready procedure before guiding the patient away from the unit, the arm could hit the patient and cause an injury.
- To perform a positioning method other than the Frankfurt plane method, the arm could hit the patient during the exposure if his head has been moved back a little. Pay attention to this point when performing a positioning method. If the patient has a large head, set the unit for "No X-ray", and do a dry run to visually check that there is no chance of the arm hitting the patient.

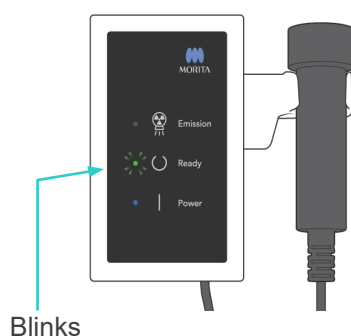

- 4) Hang the handswitch back in its holder.

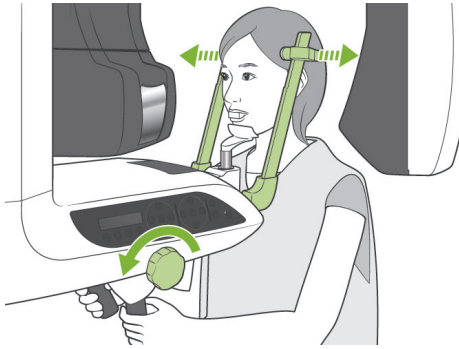

(6) Patient Egress and Image Transmission

1) Patient Egress

After the exposure, the arm will automatically go to the patient egress position, 90 degrees. Open the temple stabilizers all the way up and guide the patient away from the unit.

Then close the temple stabilizers all the way.

If the Ready key is pressed without closing the temple stabilizers, the arm will hit the temple stabilizers during its return movement.

WARNING

- *Never use excessive force to move the patient away; this could injure the patient or damage the stabilizers.*
- *Take care that the stabilizers do not strike the patient in the eye.*

* Take the mouthpiece from the patient and throw it away.



- 2) Press the Ready key on the arm operation panel or the patient frame to automatically move the arm to the patient entry position. The Ready LEDs on the operation panel and the control box will light up green to show that the unit is ready to make another panorama exposure.

WARNING

- *Make sure the patient is clear of the unit before returning the arm to the patient entry position; otherwise it could hit the patient.*
- *In case of an emergency when the arm is returning to the patient entry position, press the emission button, the Ready key on the operation panel, or the emergency switch to stop it.*

CAUTION

- *If the arm return operation is attempted without closing the temple stabilizers or without guiding the patient away from the unit after the exposure, the arm operation panel will display the message "Guide patient away and close temple stabilizers before pressing the Ready key."
If you go ahead and press the Ready key without closing the temple stabilizers or without guiding the patient away from the unit, the arm will rotate to its start position, but this can cause the arm to strike the temple stabilizers or the patient.*

- 3) During image transmission, a message will appear in the computer monitor screen.

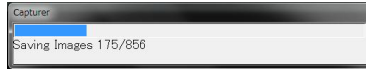

Then a progress bar will appear while the panorama image is being reconstructed.

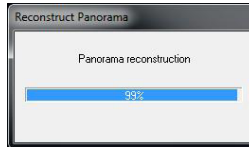

The image will appear after a few seconds.

CAUTION

- *Do not turn off the main switch until image transmission has completed and the panorama image is displayed. This will cause the image to be lost and the computer to freeze.*

Usage Note

- ◆ *After image transmission, a two-toned beep will sound. However, another exposure cannot be made until the image appears in the computer's display.*
- ◆ *During image transmission, pressing the emission button will result in a series of beeps, but X-rays cannot be emitted.*



- * For digital images, software density compensation is applied to create the optimum image. However, if some areas of the image are exceptionally dark, the density compensation will tend to make the entire image whiter than usual.
- * Depending on the X-ray emission settings and the patient's physiognomy, there may be a sudden, horizontal shift in density or light horizontal lines. This is not a malfunction or failure; it is due to subtle differences in sensitivity for sections of the Flat Panel Detector.
- * In areas with high X-ray opacity such as around Implants and prosthetics, a horizontal black line may appear. This is not a malfunction or failure; it is due to subtle differences in the individual photo diodes (pixels) on the Flat Panel Detector.

(7) Varieties of Panorama Exposures

(7)-1 Dental Arch Panorama

- 1) Press the Region key and then the Standard Panorama key.

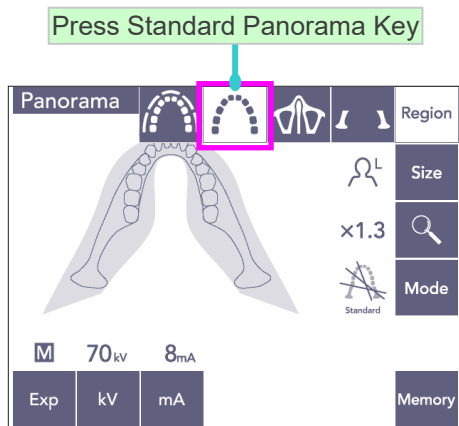

- 2) Press the Size key and then the Adult or Child key.

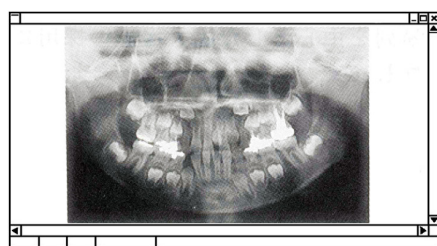
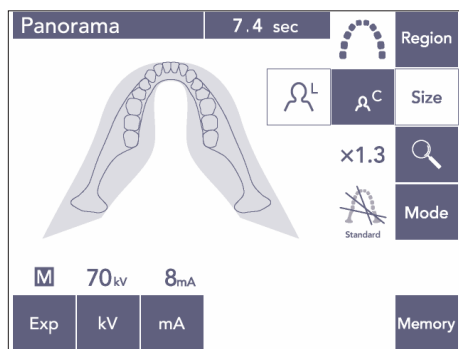
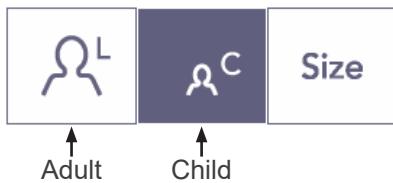

Pedodontic Panorama

For a Pedodontic (Child) panorama, the arm's angle of rotation and exposure range are reduced; the X-ray dose is also reduced by from 10% to 15%.

- * The pedodontic panorama is for people who have a small jaw bone. If the jaw bone is too large, the TMJ may not appear in the image. For the entire jaw to appear in the image, the length of a horizontal line from the center of the incisors to the outer ear orifice should be less than 70 mm.

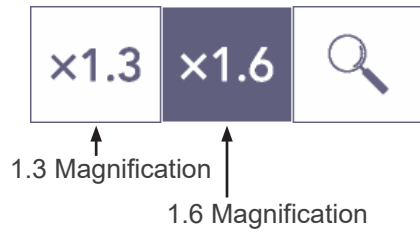

- 3) Press the Magnification key (magnifying glass) and then press $\times 1.3$ or $\times 1.6$.

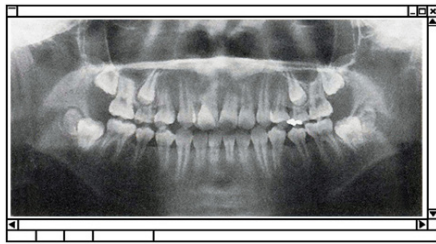

1.6 Magnification Image

If you select 1.6 magnification, the image will be about 20% larger than 1.3 \times magnification. However, the TMJ may be cut off.

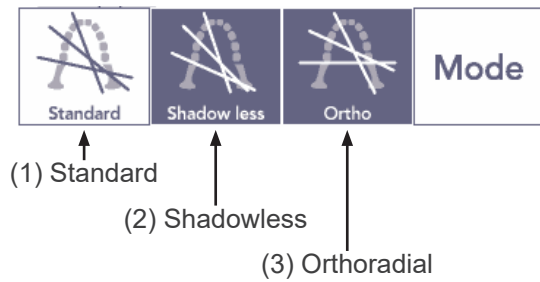

- 4) Press the Mode key and then select one of the projections.

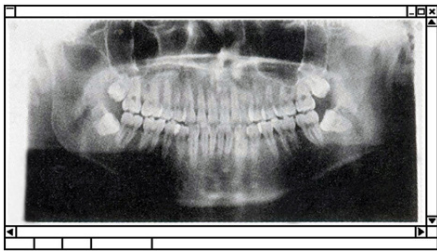

Standard Projection

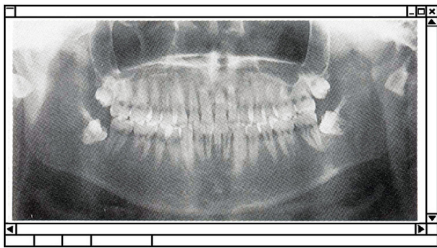
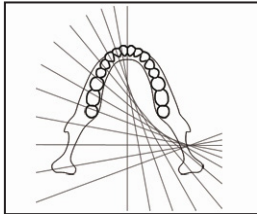

Shadowless Projection

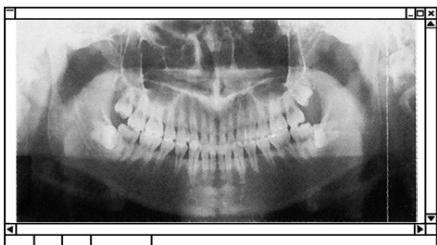
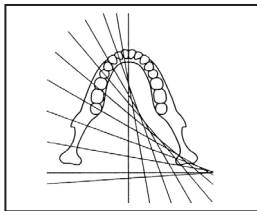

Orthoradial Projection

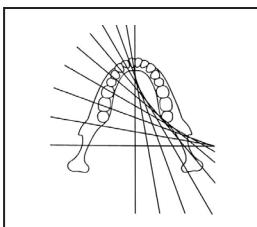

Standard Panorama Projection

The most common type.
Press the Mode key and then the Standard projection key.



Shadowless Projection

Reduces shadows obscuring the mandibular ramus.

Press the Mode key and then the Shadowless key.

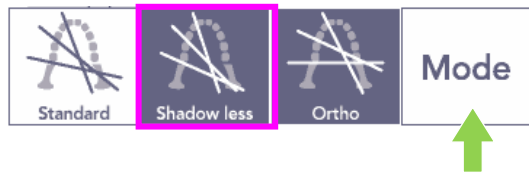

Orthoradial Projection

Reduces overlapping of teeth because X-ray beam is at a right angle to the dental arch.

Press the Mode key and then the Orthoradial Projection Key.



5) Partial Panorama

This reduces X-ray dose by not irradiating some section of the dental arch.

5)-1 Press the Region key.

Press the Partial Panorama key. This will display the dental arch divided into 5 equal sections.

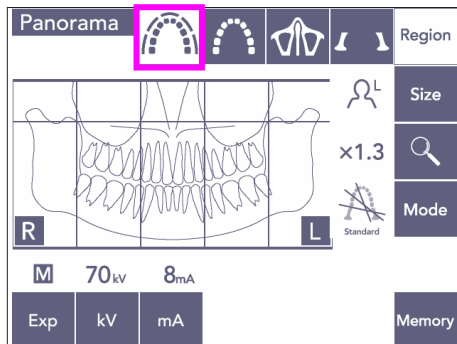

5)-2 Pressing one of the sections will change it to black and it will not be irradiated.

Press the section again to change it back to white; it will then be irradiated.

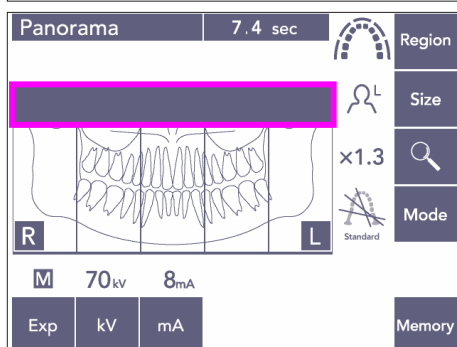
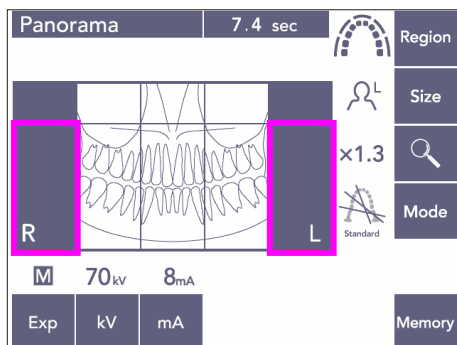
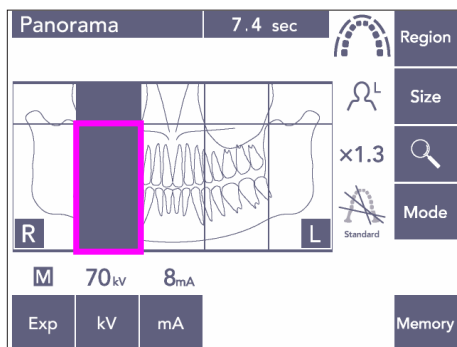

5)-3 Press any of the five sections for the maxillary sinus at the top to prevent irradiation of this whole area.

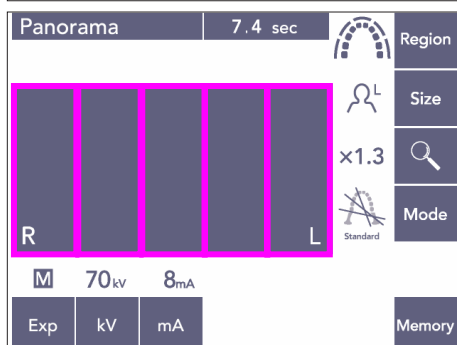

* If all the sections are pressed (black), the arm will rotate when the emission button is pressed, but no X-rays will be emitted.

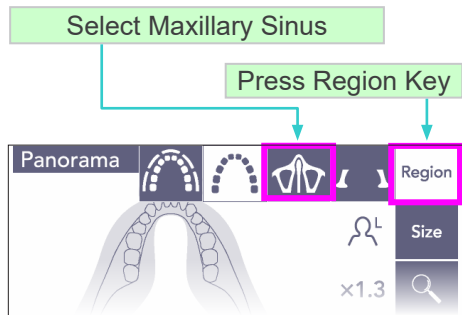

**(7)-2 Maxillary Sinus
(Mag.: 1.5x, throughout)**

Mainly used to examine the maxillary sinus or facial injuries.

- 1) Press the Region key and then the Maxillary sinus key.

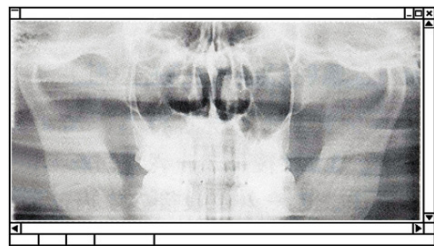
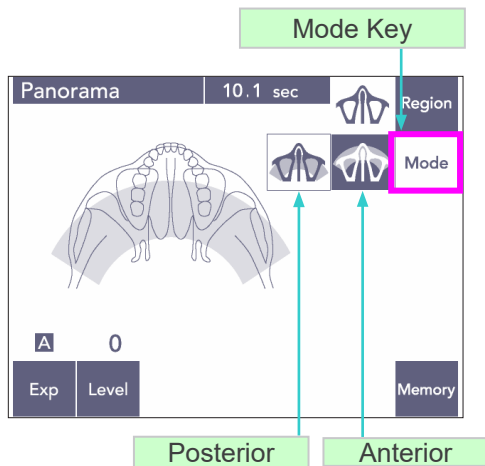

Posterior Maxillary Sinus Panorama

- 1)-A **Posterior Maxillary Sinus Panorama**
Press the Mode key and then the Posterior Maxillary Sinus key.

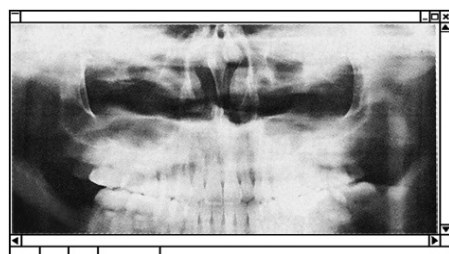

Anterior Maxillary Sinus Panorama

- 1)-B **Anterior Maxillary Sinus Panorama**
Press the Mode key and then the Anterior Maxillary Sinus key.

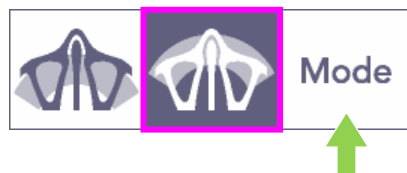

Initial patient positioning and auto positioning procedures are the same as for a standard panorama.
(See page 25, Initial Patient Positioning)



Chin Rest Position

Put the chin rest in the lowest position to make a maxillary sinus exposure.

- * If, for children or short people, the AF sensor beam does not strike the mouthpiece even when it is at its lowest setting, set the chin rest at its Medium position.

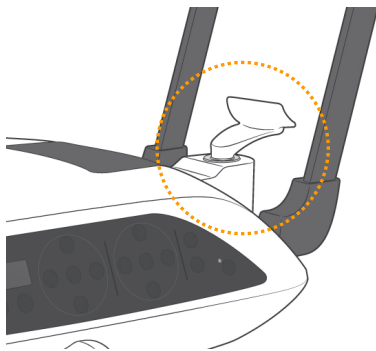

Low (for maxillary sinus)

Line up the Low Groove (see illustration) with the back of the chin rest holder.

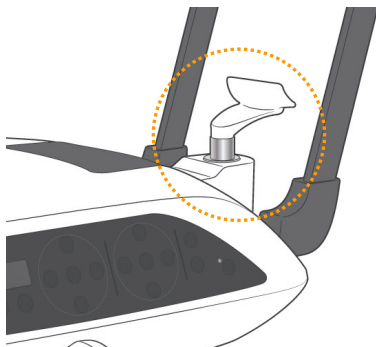

Medium (maxillary sinus for children and short people)

Line up the Medium Groove (see illustration) with the back of the chin rest holder.

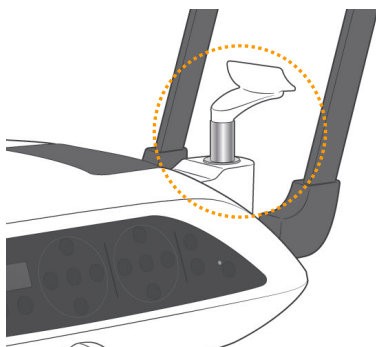

High (standard panorama)

Line up the High Groove (see illustration) with the back of the chin rest holder.

Usage Note

- ◆ *Be careful when replacing the chin rest with the lip-nose rest or the bite block; it could break if it is dropped.*

(7)-3 TMJ Quadruple (Mag.: 1.3x, throughout)

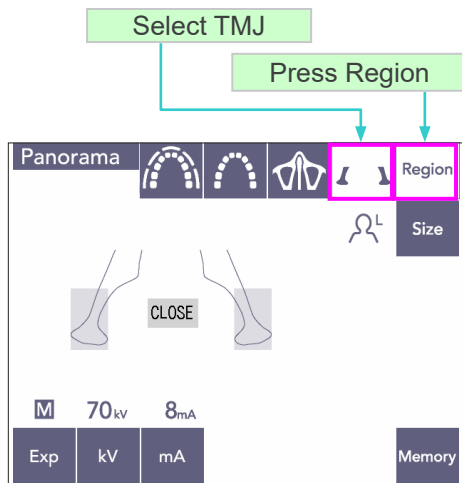

- 1) Press the Region key and then the TMJ key. Close will appear in the display.
- 2) Press the Size key and then select Adult or Child.

Estimated Distance between Joints

Adult :	100mm
Child :	90mm
Image Layer Thickness :	10.5mm
Image Layer Length :	54mm

Select the size best for the patient.

Mag.: 1.3 x

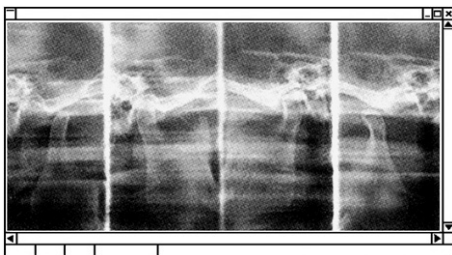

Four images will appear in the computer display: one each for the mouth open and closed on both sides. The X-ray beam angle is optimum for the average distance between the joints and the average length of the image layer. The arm rotates twice to make a complete set of images.

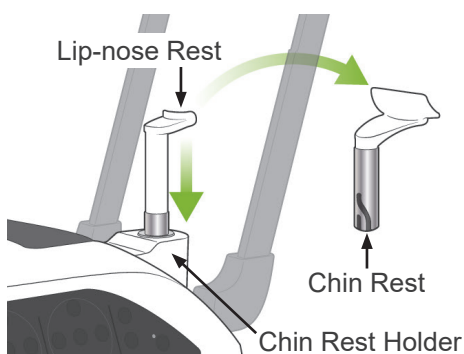

Patient Positioning

- 1) Replace the chin rest with the lip-nose rest set at medium height. (Refer to list of accessories.)

- 2) Put an X-ray protection apron with thyroid collar on the patient and stand in front of the lip-nose rest. Look at him from the side, and have him pull in his chin and straighten his back. Then look from behind and make sure his shoulders and back are straight.

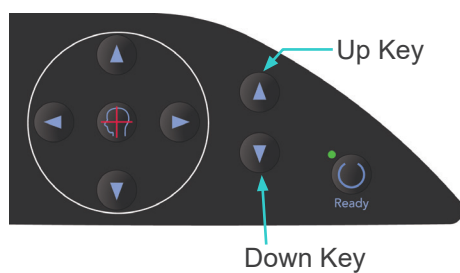
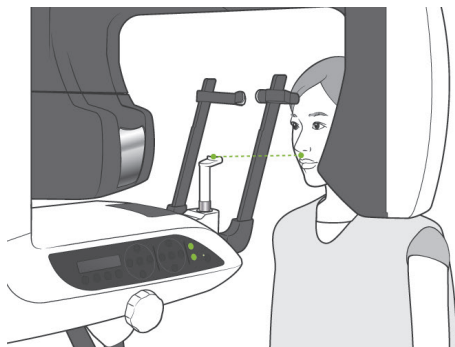
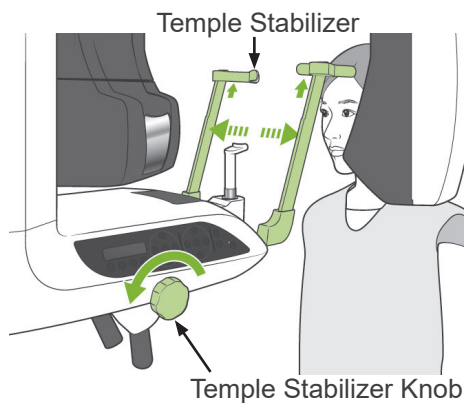

- 3) Open the temple stabilizers and use the Up or Down Lift key to raise or lower the lip-nose rest to the right height for the patient. Release the key when the rest is at the right height.

⚠ CAUTION

- Keep your fingers away from moving parts, head stabilization components, and holes in the support column.

Usage Note

- ◆ Always use the Up and Down Keys to move the Lift. Never try to force it; this would damage it.
- ◆ An excessive load will activate the protection circuit. The lift will stop and an audible signal will sound. "Lift Overload" will appear in the frame's display for about 2 seconds and then disappear.

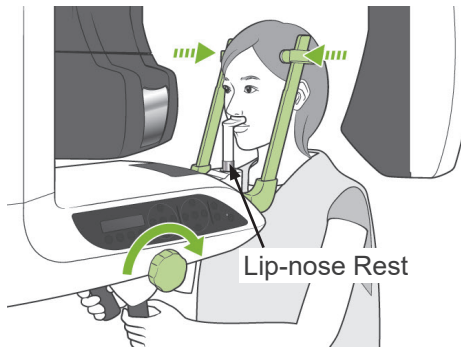

- 4) Have the patient move forward without slouching or otherwise changing his posture. Then have him put his upper lip on the lip-nose rest and lightly grip the patient handles.

⚠ WARNING

- *Take care that the temple stabilizers do not strike the patient in the eye.*

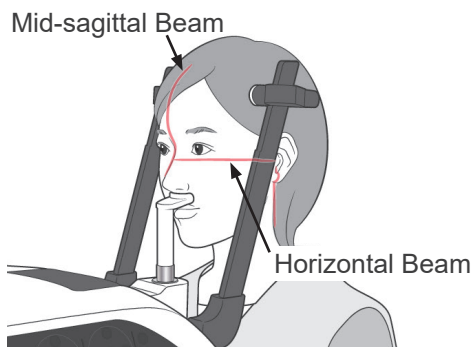

- 5) After making the patient's Frankfort plane horizontal, line up the horizontal beam with the patient's ear orifice using the beam Up or Down key. Have the patient move his head left or right until the mid-sagittal beam lines up with his mid-sagittal plane. Then tighten up the temple stabilizers.

Horizontal Beam Up/Down keys

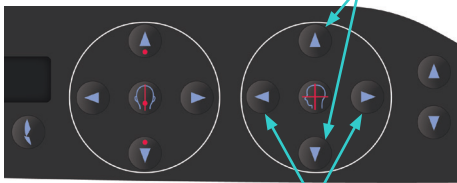

Coronal Beam keys

- 6) Use the Backward and Forward keys to line the Coronal Beam up with the patient's ear orifice. Make it perpendicular to the horizontal beam. (Arm moves from +20 mm to -16mm.)

- * The image layer is about 12 mm in front of the coronal plane beam. Have the patient close his mouth.

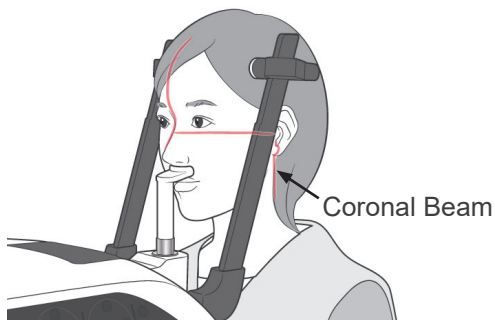

⚠ WARNING

- *The laser beams could damage the eyes. Do not stare into the positioning beams. Warn the patient not to look at the positioning beams.*

⚠ CAUTION

- *Warn the patient not to move during emission (while the melody is sounding). If the patient moves, he could be hit by the arm or the image might be ruined.*

7) Double-Ready*¹ Function

*¹ The Double-Ready function is not enabled by default. To enable the Double-Ready function, contact your local dealer or J. MORITA OFFICE.

Press the Ready key a second time after completing patient positioning in Ready mode; a two-toned beep will sound and the arm will move to its exposure start position. The Ready LED will stay on but the Coronal beam will go out.

- In the Double-Ready*¹ mode, X-ray emission starts as soon as the emission button is pressed.
- In the Double-Ready*¹ mode, other operation keys and switches are disabled except for the Ready key and Lift keys.
- In the Double-Ready*¹ mode, press the Ready key again to return to the patient positioning Ready mode.

Usage Note

- ◆ *If the patient moves out of position after the unit is set for Double-Ready*¹, press the Ready key again to return the unit to its normal Ready setting and re-position the patient.*

Closed and Open Mouth Exposures

Check that the Ready LED (green) on the patient frame, operation panel, or control box is on.



Ready LED



Ready LED

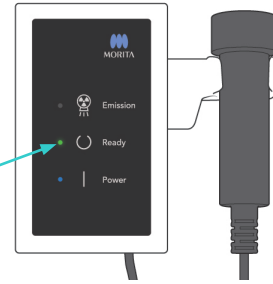

Ready LED

(8) Mouth Closed Exposure (First Exposure)

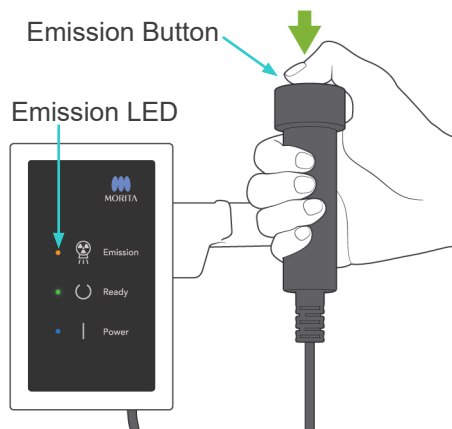

- 1) Pick up the handswitch and hold down the emission button. The arm will go to its starting position, start to rotate and exposures will be made of the left and right sides. During X-ray emission, the yellow Emission LED on the control box will light up and an audible signal will sound. Release the emission button when the arm stops rotating.

Usage Note

- ◆ It could take up to 15 seconds for emission to begin after the emission button is pressed. This is because the computer is confirming the settings on the X-ray unit and is not a malfunction.



⚠ WARNING

- Always leave the X-ray booth, and press the emission button outside of it.
- In case of an emergency, release the emission button; this will completely stop the unit.
- If, for some reason, the operator must stay in the booth during X-ray emission, he should stay at least 2 meters away from the unit and wear an X-ray protection apron with thyroid collar. He should stay out of the X-ray beam.

- 2) Have the patient stand still and maintain a good posture. Press the Ready key on the patient frame or the arm operation panel, or press the emission button. The arm will go back to its starting position.

⚠ CAUTION

- Warn the patient not to move during emission (while the melody is sounding). If the patient moves, he could be hit by the arm or the image might be ruined.

(9) Open Mouth Exposure (Second Exposure)

- 1) Open will appear in the arm display. Have the patient open his mouth.
- 2) Pick up the handswitch and hold down the emission button. The arm will start to rotate and exposures will be made of the left and right sides. Release the emission button when the arm stops rotating. The Ready LED on the control box will start blinking to show that the exposure procedure has been completed.

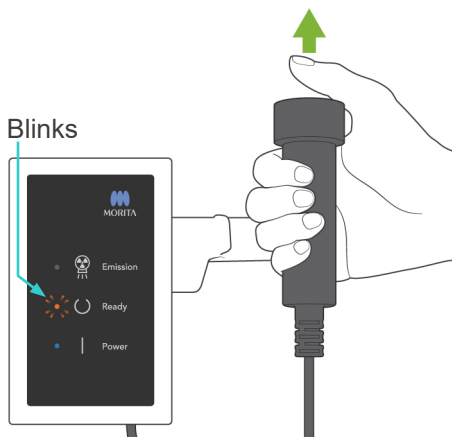

⚠ WARNING

- *Always leave the X-ray booth, and press the emission button outside of it.*
- *In case of an emergency, release the emission button; this will completely stop the unit.*
- *If, for some reason, the operator must stay in the booth during X-ray emission, he should stay at least 2 meters away from the unit and wear an X-ray protection apron with thyroid collar. He should stay out of the X-ray beam.*

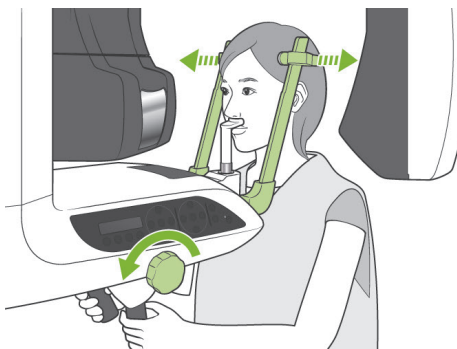

- 3) Open the temple stabilizers all the way and guide the patient away from the unit. Then close the temple stabilizers all the way.

If the Ready key is pressed without closing the temple stabilizers, the arm will hit the temple stabilizers during its return movement.

Press the Ready key on the patient frame or the arm operation panel. The arm will go back to the patient entry position and stop.

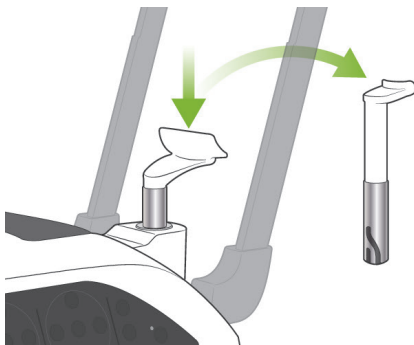

- 4) Remove the lip-nose rest and replace it with the chin rest.

3. Cephalo Exposures (option)

(1) Turn Main switch On

- 1) Press the top (|) of the main switch. The blue main LED will light up to show that the unit is on.
- 2) Press either the Ceph key to set the unit for cephalo exposure. Cephalo will appear in the title bar at the top of the screen.
- 3) Before pressing the Ready key, make sure the temple stabilizers for panorama exposures are completely closed.
- 4) Press the Ready key. The X-ray head will turn to its cephalo direction, and the arm will rotate. The arm and head automatically go into and lock in their cephalo positions.

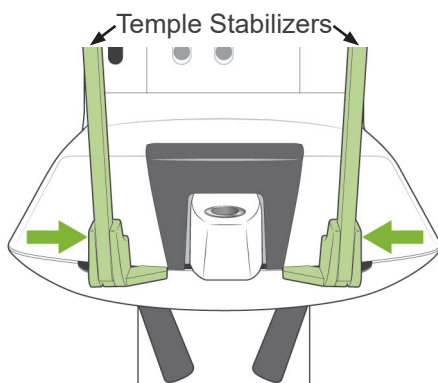
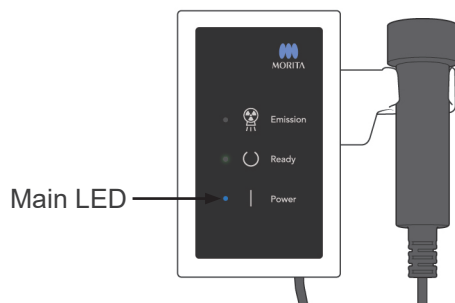
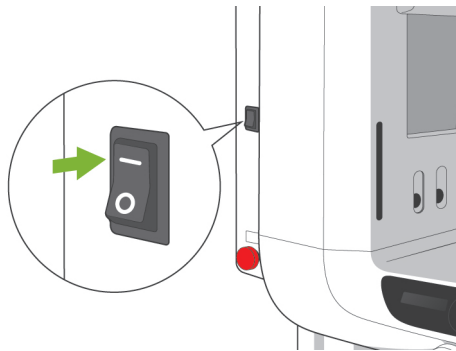

Guide patient away and close temple stabilizers before pressing the Ready key. Ready key can not be operated when the temple stabilizers are completely closed.

Usage Note

- ◆ If the temple stabilizers are not closed or the patient has not exited after the exposure, the LCD on the patient frame will display an error message.

CAUTION

- Make sure a patient is no longer near the unit, before pressing the Ready key; otherwise he could be hit by the arm.

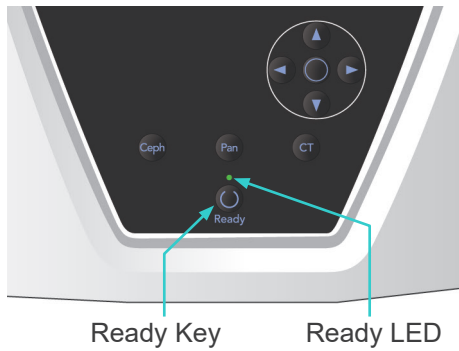

5) The green Ready LED will light up.

Usage Note

- ◆ Do not move the arm manually. The arm may not be set in the proper cephalo position if it is suddenly moved by hand. This is also true if the arm hits the operator's shoulder or something while it is moving. If the arm is accidentally turned by hand or is touched during movement, press the Pan key. Then press Ceph once again. After this press the Ready key.

(2) Emergency Stop Switch

In case of an emergency, press the Emergency Stop Switch. This will stop the arm's rotation, lift movement and X-ray emission. Do not use this switch for anything. If the Emergency Stop Switch is pressed, the lift will stop within 10 mm and the arm rotation within 15 degrees.

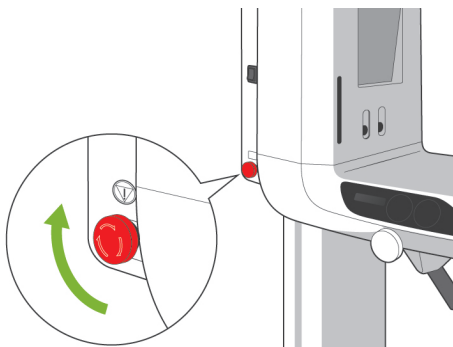
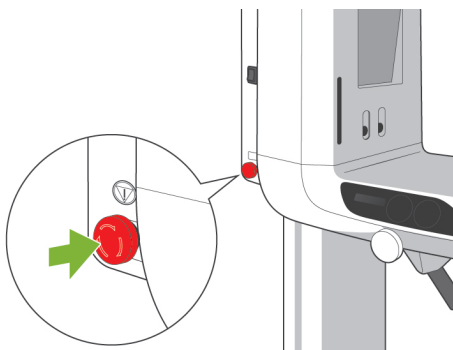

After Pressing the Emergency Switch

Guide the patient away from the unit and turn the main switch off. This will return the unit to a safe condition.

Turn the switch in the direction indicated by the arrow and restart the computer. Then turn the main unit back on and check that it is set for Panorama Exposure. If the unit cannot be returned to a safe condition or will not operate, contact your local dealer or J. MORITA OFFICE.

⚠ CAUTION

- The image will be lost if the Emergency Stop Switch is pressed during its transmission or if the main switch is turned off.

(3) Lateral Exposure

1) Press the Mode key and then the Lateral key.

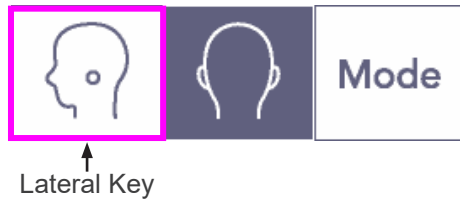

2) Turn the Dens Comp key on to select both the required soft and hard tissues for making cephalo measurements.

To get soft tissue images, the tube current changes during the irradiation; therefore the tube current does not appear in the display. The Density Compensation is not the same as automatic exposure.

(Soft tissues will not appear if the Dens Comp key is turned off.)

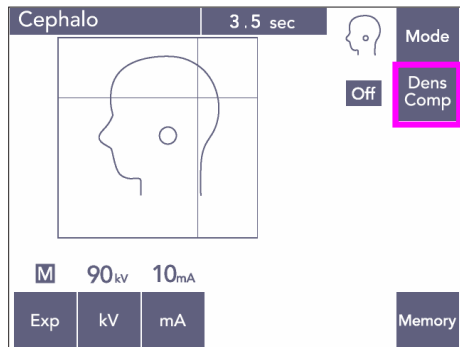

- * When the Density Compensation key is turned on, the arm operation panel will display "90 kV."
- * For children, set the tube voltage for 80 kV.
- * Cephalo exposures cannot be made with Auto Exposure.

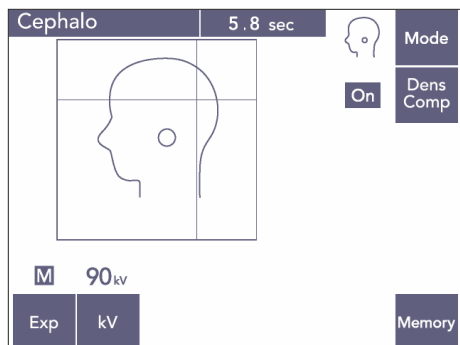

Partial Cephalo

To reduce X-ray dose, you can set the unit to not irradiate the top or the back of the head or both.

Press the rectangular sections in the display to change them to black. Black sections will not be irradiated.

Press the section again to change it back to white.

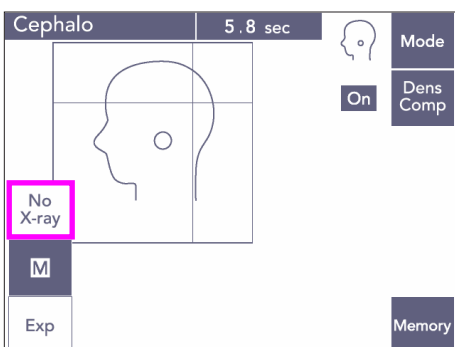
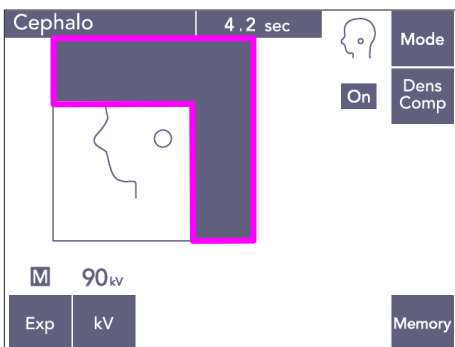
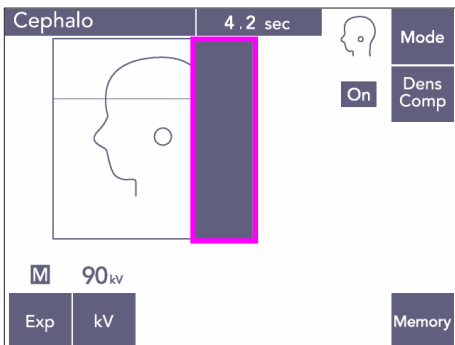
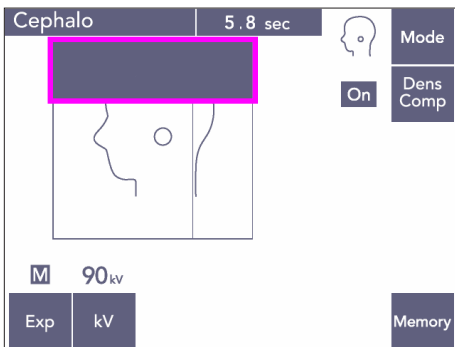

- * Set the unit for No X-ray to test the movement of the secondary slit and cephalo detector without emitting X-rays.

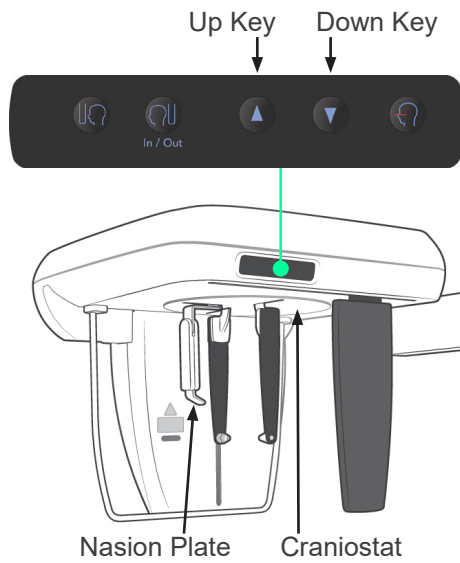

(4) Patient Positioning

- 1) Use the Up or Down key to raise or lower the craniostat match the patient's height. Release the key to stop the craniostat moving.

Usage Note

- ◆ An excessive load could activate the overload protection circuit. A warning beep will sound and the message "Lift Overload" will appear in the frame display for about 2 seconds and then disappear.
- ◆ Always use the Up and Down Keys to move the craniostat. Never try to force it; this would damage it.

CAUTION

- Keep fingers away from gaps and openings for moving parts such as the temple stabilizers, craniostat components as well as the holes on the support column.

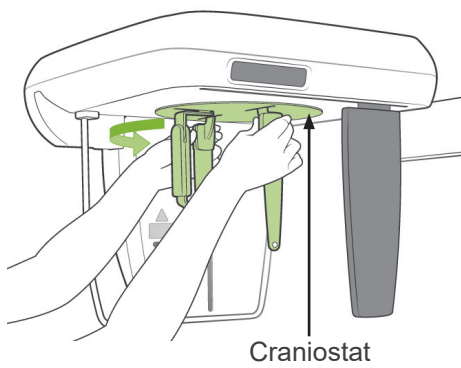

- 2) Grip the base of the ear rod plates and rotate the craniostat to its Lateral position.

⚠ CAUTION

- *The nasion plate must be at the front; a proper exposure cannot be made if it is reversed.*

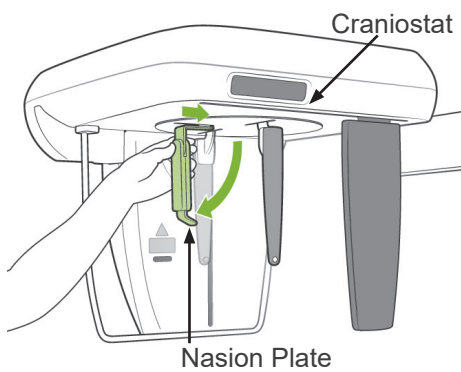

Usage Note

- ◆ *Rotate the craniostat with the nasion plate down and pushed in.*
- ◆ *To move the nasion plate, grip the base of its arm, not the end. Otherwise this could be damaged.*

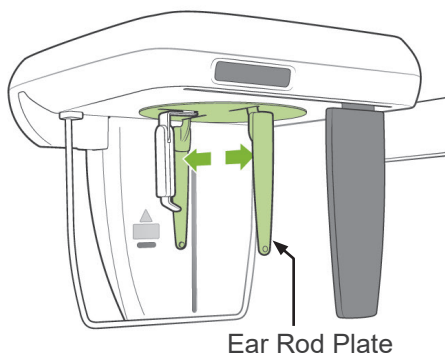

- 3) Grip the ear rod plates with both hands and open them up all the way.

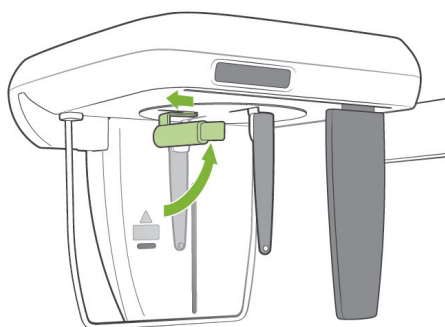

- 4) Make it easy for the patient to take his place by raising the nasion plate and pulling it out.

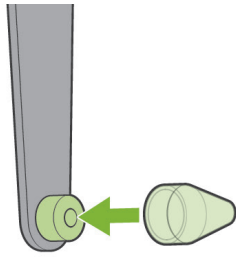

- 5) Check if the ear rods are set on their studs.

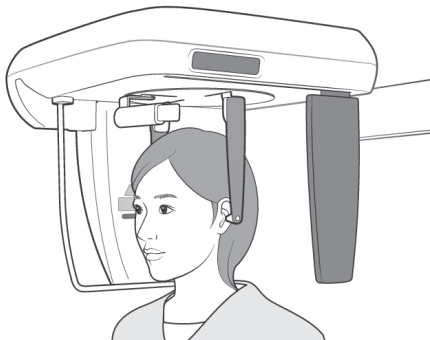

- 6) Have the patient stand directly underneath the craniostat.

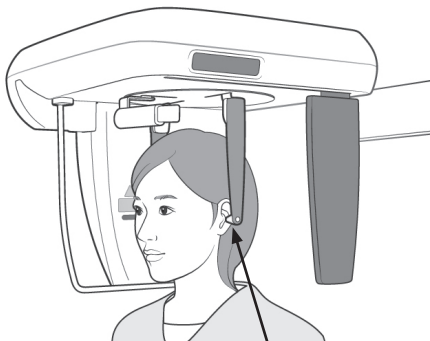

- 7) With the Up or Down key, raise or lower the craniostat until the ear rods line up with the patient's outer ear orifice and then release the key.

Ear Rod

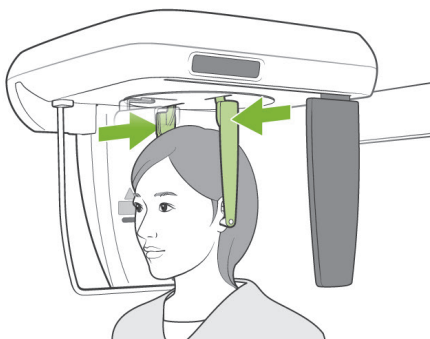

- 8) Grip the ear rod plates with both hands and carefully close them until the ear rods go into the patient's ears.

WARNING

- *Be extremely careful when inserting the ear rods and do not move the craniostat after they have been inserted. This could seriously injure the patient.*

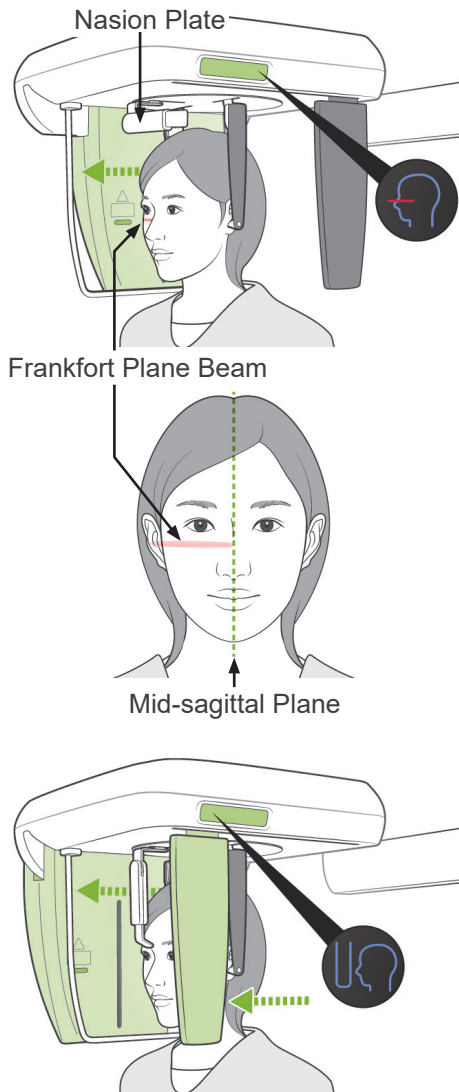

- 9) Use the key for the Frankfort Plane Beam to line it up with the patient's Frankfort Plane and make sure that it is perpendicular to the patient's mid-sagittal plane. Adjust the length of the nasion plate and put it against the patient's nasion.

⚠ WARNING

- *The laser beams could damage the eyes. Do not stare into the positioning beams. Warn the patient not to look at the positioning beams.*

The Frankfort plane beam does not work, even if its key is pressed, if the unit is set up to make lateral exposures with the patient facing the opposite of the usual direction.

- 10) After making sure the mid-sagittal and Frankfort plane beams are lined up and the ear rods are in place, press the Start Position Key: 

⚠ WARNING

- *Never let the patient hold onto the patient guard.*

NG

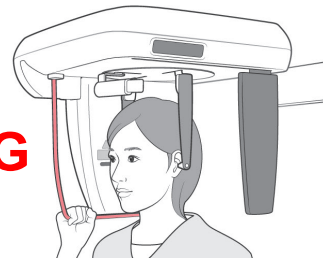

- 11) The cephalo detector and secondary slit plate will move into their starting positions.

⚠ CAUTION

- *Warn the patient not to move during emission (while the melody is sounding). If the patient moves, he could be hit by the arm or the image might be ruined.*
- *Make sure the cephalo detector or the secondary slit plate will not hit the patient's shoulder.*

(5) X-ray Emission

- 1) Check the arm operation panel, patient frame or control box, and make sure the green Ready LED is on.



Ready LED



Ready LED

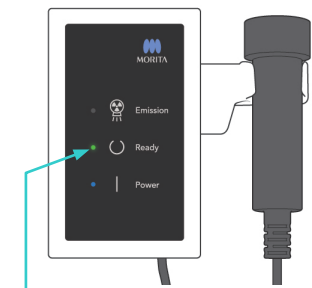

Ready LED

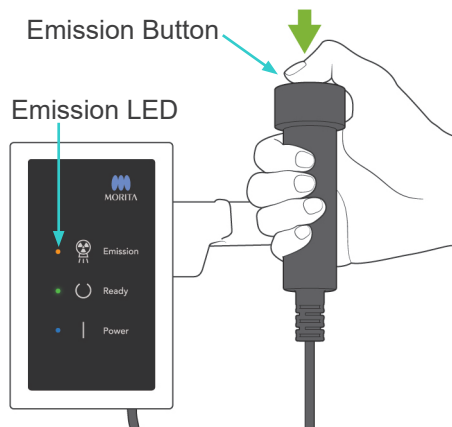

- 2) Pick up the handswitch and hold down the emission button. After a few seconds the secondary slit will start to move and X-rays will be emitted. During X-ray emission, the yellow Emission LED on the control box will light up and an audible signal will sound.

Usage Note

- ◆ *It could take up to 15 seconds for emission to begin after the emission button is pressed. This is because the computer is confirming the settings on the X-ray unit and is not a malfunction.*



- 3) Keep holding the emission button down. When the exposure is finished, the secondary slit plate will stop moving and X-ray emission will also stop. The Emission LED will go out, and the audible signal will stop.

Now release the emission button. The Ready LED will change to amber and start blinking and amber to show that the image is being transmitted. After transmission is completed, the Ready LEDs on the arm and control box will change back to green and blink on and off.

WARNING

- *Always leave the X-ray booth, and press the emission button outside of it.*
- *In case of an emergency, release the emission button; this will completely stop the unit.*
- *If, for some reason, the operator must stay in the booth during X-ray emission, he should stay at least 2 meters away from the unit and wear an X-ray protection apron with thyroid collar. He should stay out of the X-ray beam.*

CAUTION

- *Warn the patient not to move during emission (while the melody is sounding). If the patient moves, the image might be ruined.*
- *The image could be distorted if the secondary slit or the cephalo detector hit the patient's shoulder during emission.*
- *Hold the emission button down until the entire procedure is completed; releasing the button will terminate the exposure procedure.*
- *If an exposure has been terminated before completion, guide the patient away from the unit. Press the Ready key, repeat the patient positioning and then make the exposure.*

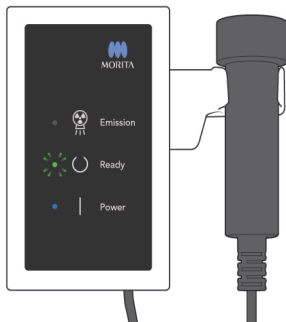

- 4) Hang the handswitch back in its holder.
- * Hanging a mirror on the wall where the patient can see it helps to keep the patient from moving during X-ray emission.

(6) Patient Egress and Image Transmission

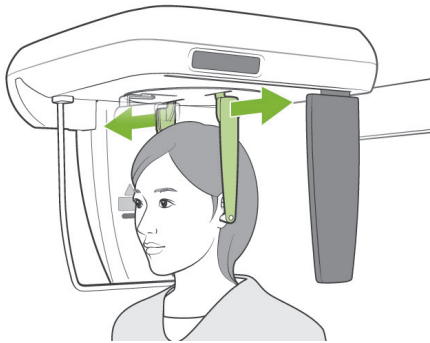

- 1) Use both hands to carefully open the ear rod plates and get the ear rods out of the patient's ears.

⚠ WARNING

- *Open the ear rod plates very carefully and make sure the ear rods are well clear of the patient's ears; otherwise the patient could be injured.*

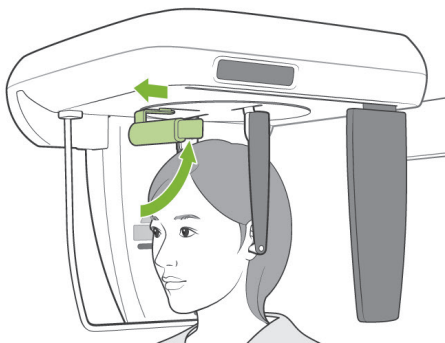

- 2) Pull the nasion plate out and raise it up; then guide the patient away from the unit.

- 3) "Transferring image!" will appear in the computer display, and after about 30 seconds the image will appear.

⚠ CAUTION

- *Do not turn off the main switch until image transmission has completed and the cephalo image is displayed.. This will cause the image to be lost and the computer to freeze.*

Usage Note

- ◆ *After image transmission, a two-toned beep will sound. However, another exposure cannot be made until the image appears in the computer's display.*
- ◆ *During image transmission, pressing the emission button will result in a series of beeps, but X-rays cannot be emitted.*



- * Software density compensation is applied to create the optimum image. However, if some areas of the image are exceptionally dark, the density compensation will tend to make the entire image whiter than usual.
- * For a digital image, there are junction lines that are not visible when the image is displayed initially. However, if the image is magnified, they appear as fine, horizontal lines dividing the image in thirds. These lines are where the three CCD sensors come together.

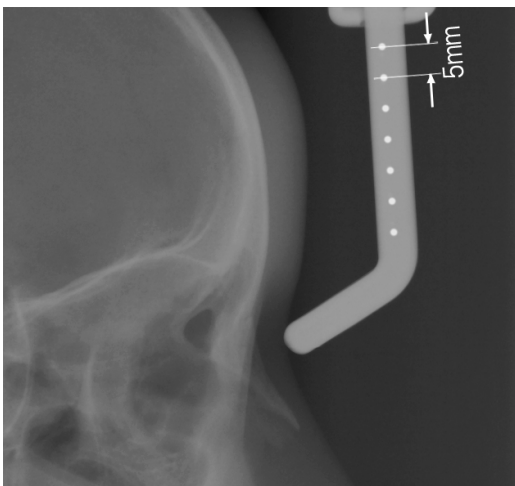

- * There are seven, one-millimeter steel balls lined up in the center of the nasion plate at intervals of five millimeters. For the default setting in the i-Dixel program, the balls will be spaced at five millimeter intervals in the image, but they will be spaced at 5.5 millimeter intervals if the data is exported, i.e. the image will be magnified by 1.1 times. These balls can be used to estimate lengths when, for instance, using analysis software.

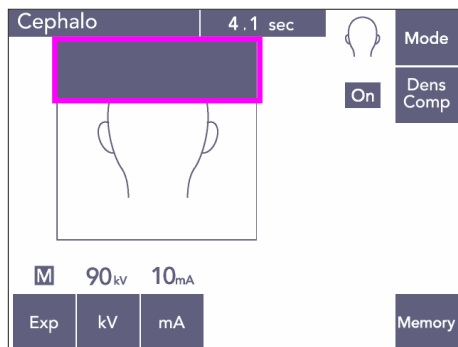
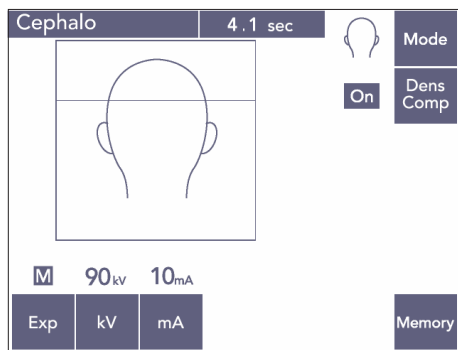
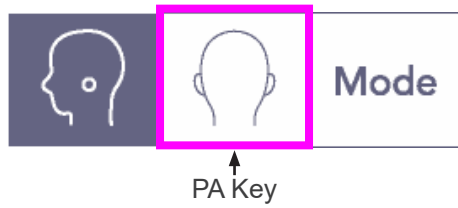

(7) PA (posterior-anterior) Exposure

- 1) Press the Mode key and then the PA key.
 - * 90 kV and 10 mA will appear in the display.
 - * Cephalo exposures cannot be made with Auto Exposure.

- 2) Turn on the Dens Comp key to select both the soft and hard tissues for making cephalo measurements.

(Soft tissues will not be selected if the Dens Comp key is turned off.)

Partial Cephalo

To reduce X-ray dose, you can set the unit to not irradiate the top of the head.

Press the rectangular section in the display to change it to black. The black section will not be irradiated.

Press the section again to change it back to white.

Patient Positioning

Turn the craniostat to the PA position.

- * Otherwise, positioning, X-ray emission, and patient egress are all the same as for the LA exposure. However, the nasion plate should be raised up.

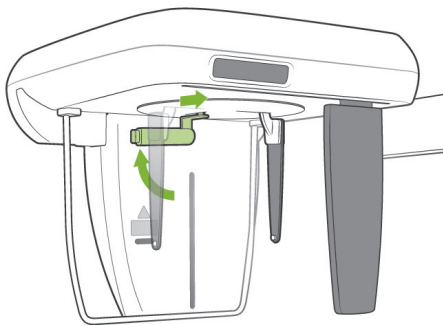
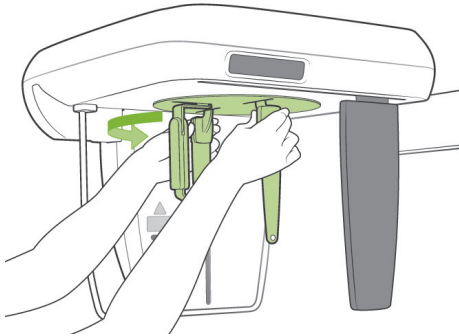

Usage Note

- ◆ Do not slide the nasion plate out; it could be broken.
- ◆ Put the nasion plate in the position shown in the photo to the left.

45 Degree Slant Exposure

Set the craniostat at a 45 degree angle to either the right or left.

- * Set the unit for a PA Exposure.

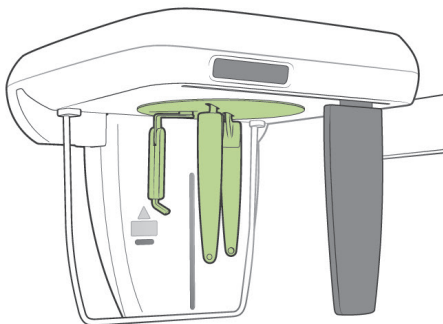

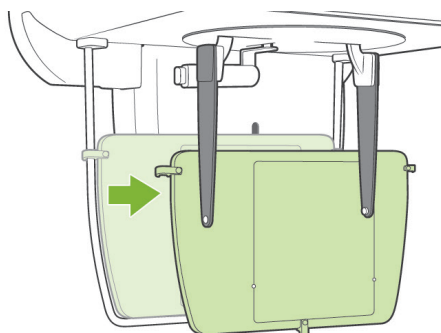
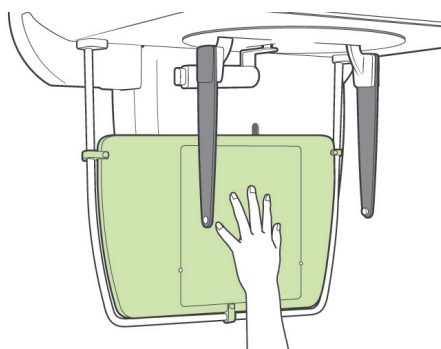
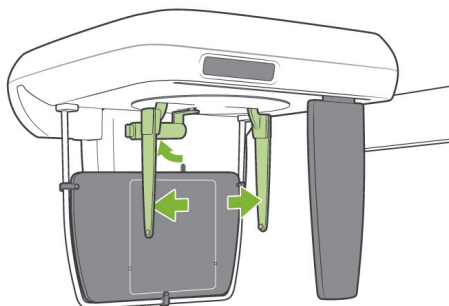
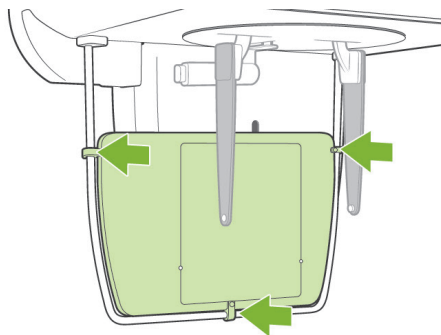
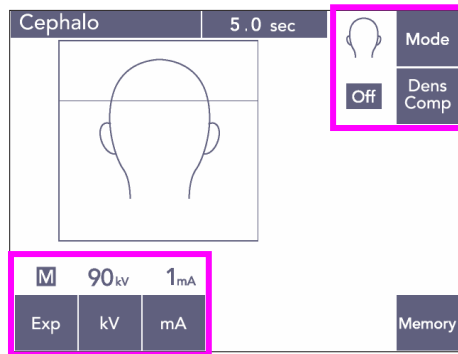

Hand Exposure

- 1) Set for PA exposure.
- 2) Turn the Dens Comp key off.
- 3) Set tube current for 1 mA.
 - * 90 kV and 1 mA are rough estimates for a child, but mA can be adjusted depending on the patient's size.
 - * Cephalo exposures cannot be made with Auto Exposure.
- 4) Attach the Hand X-ray Plate to the patient guard.
- 5) Set the craniostat in the PA Exposure position. Raise the nasion plate up. Open the ear rod plates all the way.
- 6) Have the patient place his hand inside the rectangle on the Hand X-ray Plate.

⚠ CAUTION

- Make sure nothing other than the patient's hand is inside the rectangle on the Hand X-ray Plate.
- Do not fail to take the Hand X-ray Plate off after completing the exposure. Otherwise, the next cephalo exposure made could be ruined.

- * The X-ray emission procedure is the same as that for cephalo exposures.
- * Remove the Hand X-ray Plate after completing the exposure.

(8) Notes for Exporting Digital Cephalo Data for Software Analysis

Digital cephalo data must be calibrated for whatever analysis software you are using.

CAUTION

- *Measurements will not be correct if the data is not calibrated.*

- * Cephalo image data is equivalent to 264.6 dpi.
- * Refer to the user’s manual for your analysis software for instruction on how to calibrate the data.

Calibration Data

- * A CD with the calibration data is provided. It is titled “Chart(264dpi).jpg.”

How to Use the Calibration Data

- Import the data into your analysis software.
- Refer to the user’s guide for your analysis software to perform the calibration.
 - * The distance from the center of one cross to the next in the data image is 27.5 mm. Therefore, the total distance of 4 crosses is 110 mm.
- Based on the above distances, select calibration points and check the distance between them. For example, calibrate the software so that the distance from one cross to the fourth cross away from it is 110 mm.
- Keep the calibration data in a handy, safe place. We recommend that you copy the data onto your hard drive in a folder named “C:\Program Files\3dxcom”

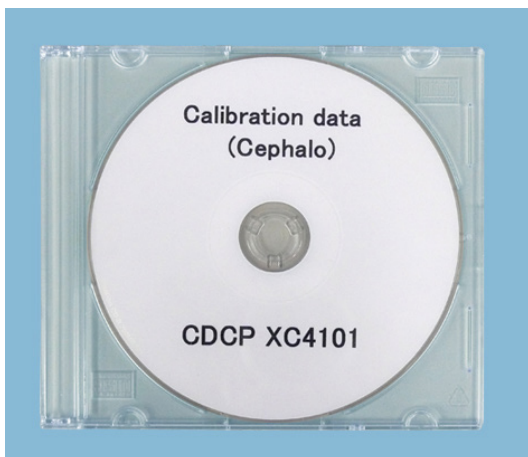

CD-R

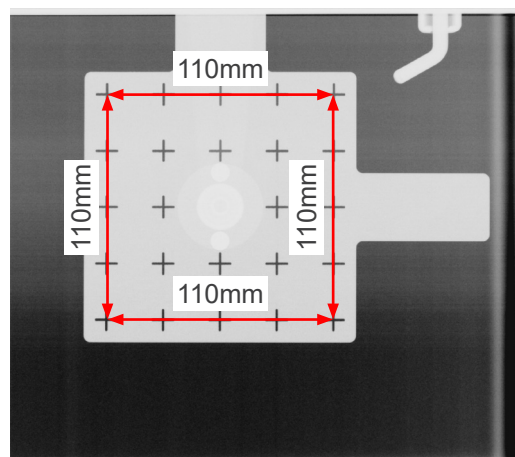
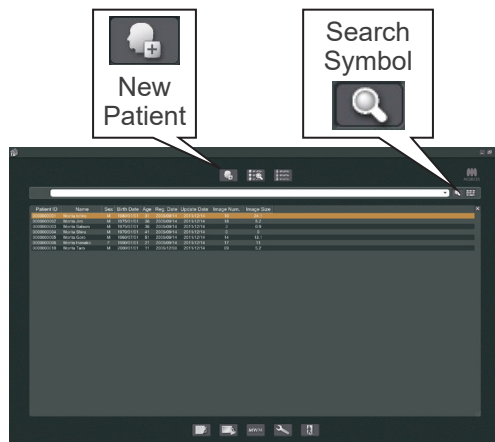

Chart (264dpi).jpg

4. CT Exposure



Turn on the computer and start up the i-Dixel application. Then bring up the patient list.

- * Simply click the search symbol (magnifying glass) at the end of the search field to bring up the complete list of patients.

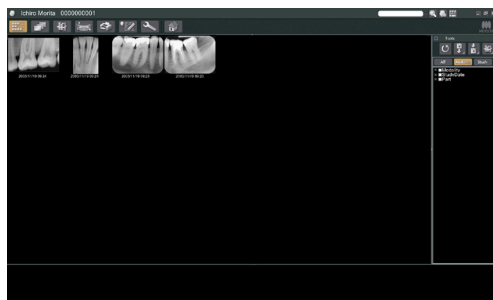

Select the patient for whom you will make an exposure and display his image list. (For new patients, click the New Patient button, register the patient and then display the image list page.)

Make the exposure while the image list page is being displayed.

- * For details refer to the user manual for the i-Dixel application.
- * Resolution for CT exposures is set automatically and cannot be changed.

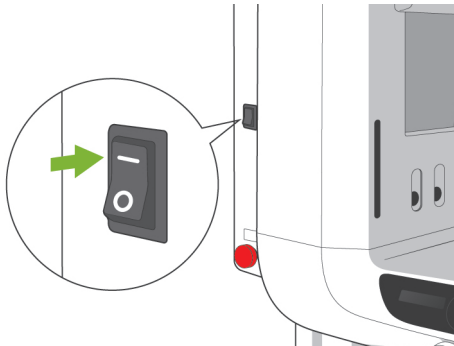

(1) Turn Main switch On

Press the top (|) of the main switch. The blue main LED on the control box will light up to show that the unit is on.

 CAUTION
<ul style="list-style-type: none"> Do not turn the main switch on if the patient is standing near the unit. The arm will move and it could hit the patient.

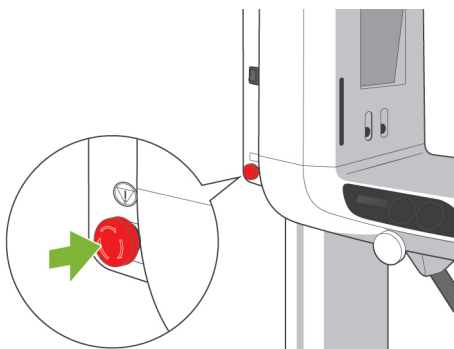
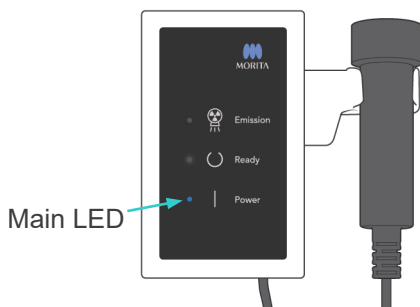

(2) Emergency Stop Switch

In case of an emergency, press the Emergency Stop Switch. This will stop the arm's rotation, lift movement and X-ray emission. Do not use this switch for anything. If the Emergency Stop Switch is pressed, the lift will stop within 10 mm and the arm rotation within 15 degrees.

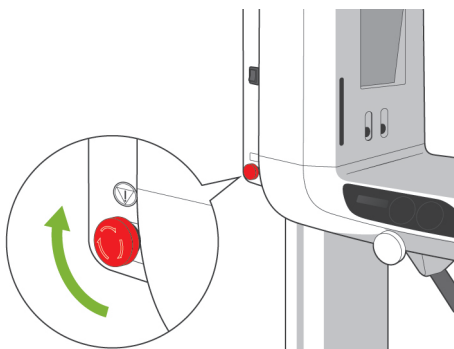

After Pressing the Emergency Switch

Guide the patient away from the unit and turn the main switch off. This will return the unit to a safe condition.

Turn the switch in the direction indicated by the arrow and restart the computer. Then turn the main unit back on and check that it is set for Panorama Exposure. If the unit cannot be returned to a safe condition or will not operate, contact your local dealer or J. MORITA OFFICE.

 CAUTION
<ul style="list-style-type: none"> The image will be lost if the Emergency Stop Switch is pressed during its transmission or if the main switch is turned off.

(3) CT Exposure Sizes

Diam. 40 × Height 40 mm







































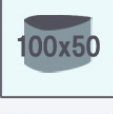

Diam. 40 × Height 80 mm

Diam. 80 × Height 50 mm

Diam. 80 × Height 80 mm

Diam. 100 equivalent × Height 50 mm

Diam. 100 equivalent × Height 80 mm

Pan		Ceph	FOV	CT			
Area	Rest	Projection		Area	Rest	Positioning	
 Dental Arch  Maxillary Sinus  TMJ	 Chin Rest H  Chin Rest L  Lip-Nose Rest M	 Lateral  Posterior-anterior	 40x40	 Dental Arch  Maxillary Sinus  TMJ	 Bite Block H  Bite Block L  Lip-Nose Rest M	 Two-Direction Scout  Manual	
			 80x50	Dental Arch	50 Maxillary Mandible	 Bite Block L  Bite Block H	 Two-Direction Scout  Manual
			 80x80		80	 Bite Block H	 Manual
 Dental Arch  Maxillary Sinus  TMJ	 Chin Rest H  Chin Rest L  Lip-Nose Rest M	 Lateral  Posterior-anterior	 100x50	Dental Arch	50 Maxillary Mandible	 Bite Block L  Bite Block H	 Two-Direction Scout  Manual
			 100x80		80	 Bite Block H	 Manual

* Rest usage in the above chart is a general estimate. Use the type of rest at the right height so that the exposure area will be centered.

(4) Limited Field CT Exposure

(4)-1 CT Exposure Settings

- 1) Press the CT key on the arm operation panel.
The CT display will appear.

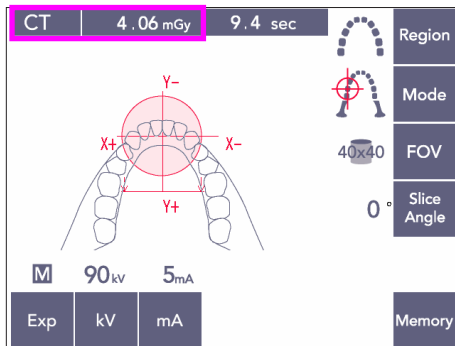

- 2) "CT" will appear in the title bar.
The number next to "CT" on the title bar is the CT DIvol (volume computed tomography dose index) as measured and calculated following IEC60601-2-44.

(4)-2 Exposure Types

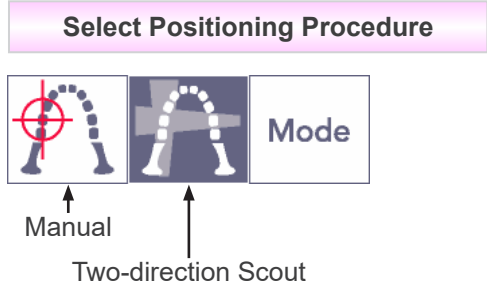
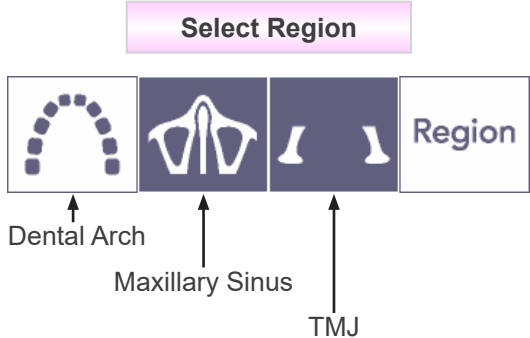

* Select Manual for maxillary sinus and TMJ. For the dental arch use either Manual or the two-direction Scout.

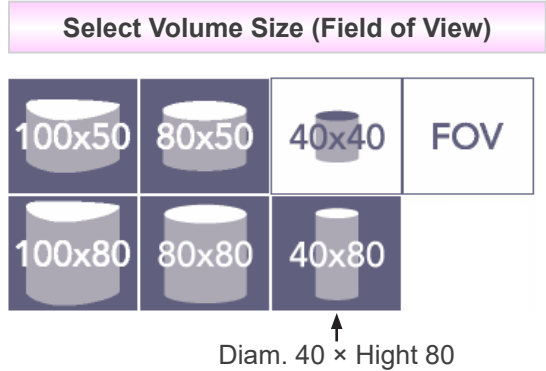

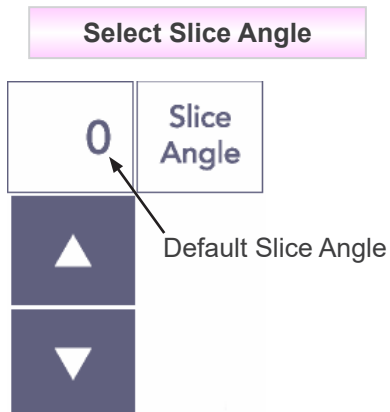

- * From -90° to $+90^{\circ}$ in 5° increments.
 Slice angle can only be set for 40×40 and 40×80 exposures.
 A beep will sound if you try to set it for other FOVs.

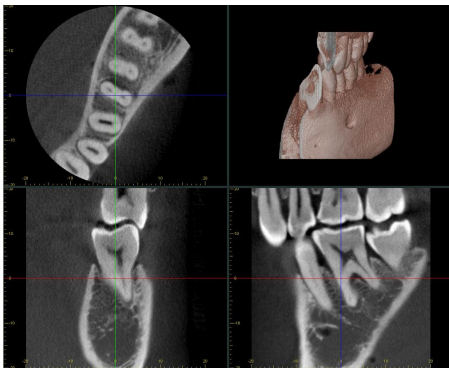

For example, you could set the slice angle so that the sagittal plane (X plane) lines up with the dental arch. This will make the images easier to understand.

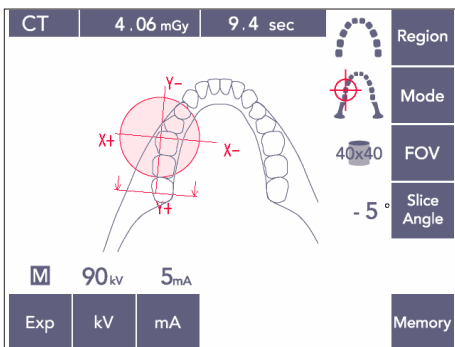

Press the Slice Angle key to adjust the angle with the Up and Down keys.

For details on desirable slice angles, refer to the manual for the i-Dixel application.

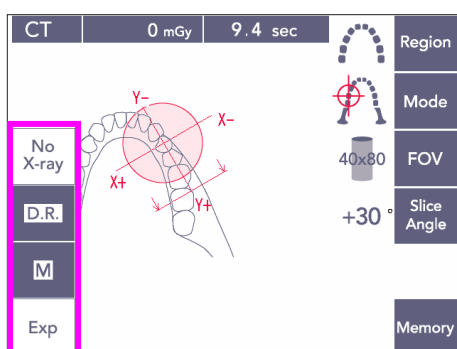
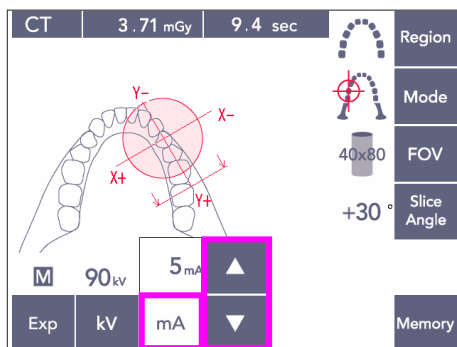
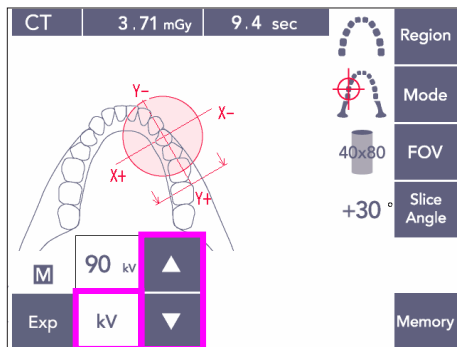

(4)-3 Exposure Conditions

- 1) Press the Exp key and check that the unit is set for Manual exposure.
- 2) Press the kV key and adjust the value with the Up and Down keys.

- 3) Press the mA key and adjust the value with the Up and Down keys.

- * Recommended settings: 90kV and 3 to 5 mA
- * CT exposures cannot be made using Auto exposure.

- 4) Press the Ready key. Its LED will light up.

Usage Note

- ◆ Close the temple stabilizers all the way before pressing the Ready key; otherwise, the arm might hit them, which could damage the arm or the stabilizers.

WARNING

- Strong X-ray emission can saturate the photo diodes on the sensor for areas having high X-ray transparency. In the resulting image, this might falsely appear to be a complete absence of tissue. Watch the rotating image produced during X-ray emission to see if this happens and take this into consideration when making a diagnosis.

- * Set the exposure for No X-ray to make sure the arm will not hit the patient or perform other tests without emitting X-rays.

Dose Reduction (D.R.) Exposure

X-ray dose is reduced by lowering the tube current for areas with greater X-ray transparency and is only 60% compared to using a fixed value for tube current. It also improves image quality by reducing the load on the X-ray detector.

- 1) Press the Exp key and then the D.R. key.
 - * This cannot be used for TMJ CT images. ^{*1}

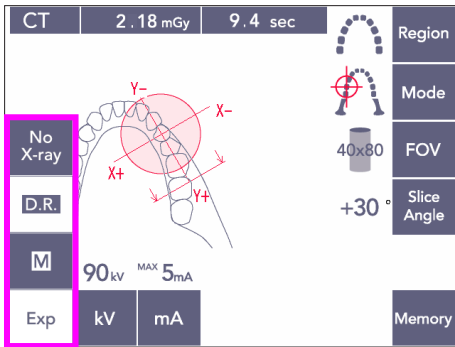

- 2) Press the kV key and adjust the value with the Up and Down keys.

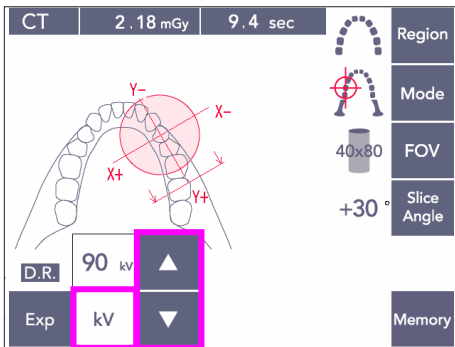

- 3) Press the mA key and adjust the value with the Up and Down keys.

* The mA display shows the maximum tube current used during X-ray emission. This can be set from 3 to 10 mA, but only from 3 to 8 mA if the tube voltage is 85 kV or more. ^{*2}

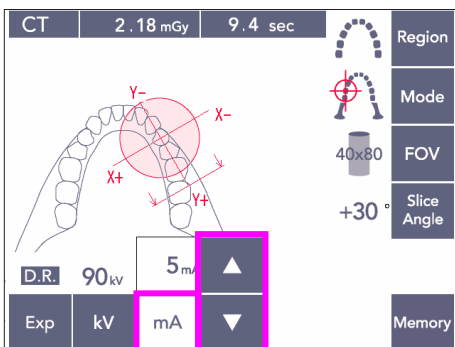

- 4) Press the Ready key. Its LED will light up.



^{*1} While the D.R. mode improves the imaging for the jaw and buccal areas where there is greater X-ray transparency, the imaging for molar areas is not necessarily better. D.R. mode is not effective and cannot be used for TMJ imaging.

^{*2} The D.R. mode is not automatic density compensation; it works by regulating the tube current within a set range. The regulation of the current is timed by anticipating areas such as the cervical region where X-ray absorption will be greater. The D.R. mode works as long as the maximum current is set for 3 mA or greater. The mA setting represents the maximum tube current for the exposure. Usually the mA setting can be left at its normal setting. If the mA is set for less than 3 mA, it will automatically go up to 3 mA when the unit is set for D.R. mode.

(5) Patient Positioning

For CT exposures, replace the chin rest with the bite block. This will help the patient hold his head steadier and has greater reproducibility.

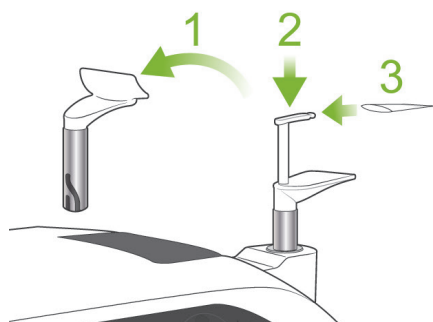

- * For edentulous patients or others who cannot use the bite block, use the chin rest.
- * Auto Positioning cannot be used with the bite block.
- * Some part of the bite block will appear in the image.

1) Replace the chin rest with the bite block.
Put a cover on the bite block.

2) Have the patient put on an X-ray protection apron with thyroid collar.
Open the temple stabilizers and have the patient step up to the unit.

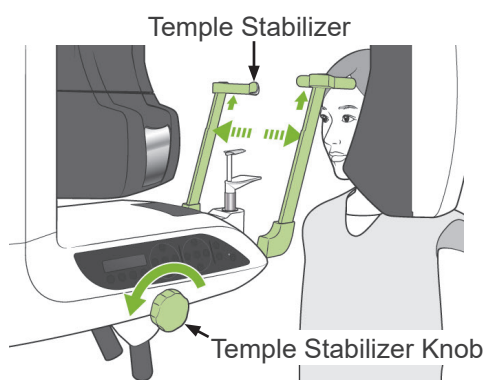

WARNING

- *A new, uncontaminated bite block cover must be used for each patient to prevent from cross-contamination.*
- *Take care that the temple stabilizers do not hit the patient in the eye.*

CAUTION

- *Have the patient remove glasses, ear rings, and other accessories. These could ruin the image.*
- *Undo a pony tails so that the arm will not hit it.*

Usage Note

- ◆ *Keep bite block covers in a clean, uncontaminated area.*

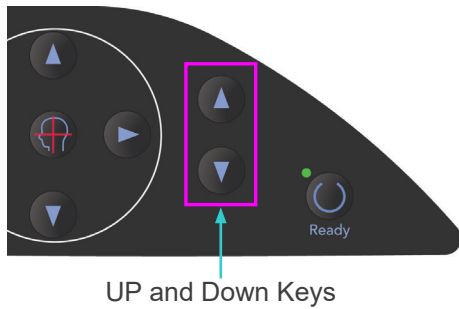

UP and Down Keys

- 3) Use the Up and Down keys to match the lift with the height of the patient.

⚠ CAUTION
<ul style="list-style-type: none"> • <i>Keep fingers away from gaps for moving parts such as the temple stabilizers as well as the holes on the support column.</i>

Usage Note

- ◆ *Always use the Up and Down Keys to move the Lift. Never try to force it; this would damage it.*
- ◆ *An excessive load will activate the protection circuit. The lift will stop and an audible signal will sound. "Lift Overload" will appear in the frame's display for about 2 seconds and then disappear.*

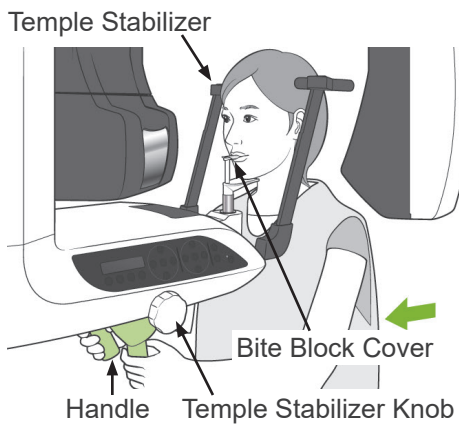

- 4) Have the patient stand straight, move forward and lightly take the bite block in his mouth and then set his chin on it. Have him grip the handles and lower his shoulders. Close the temple stabilizers until they lightly contact the patient's head. Use the laser beams as described in "Patient Positioning" in the section for Panorama Exposures and then close the temple stabilizers firmly.

Usage Note

- ◆ *Before pressing the Ready key, make sure the temple stabilizers are closed. The arm could hit them if they are left open.*

⚠ CAUTION
<ul style="list-style-type: none"> • <i>Do not use excessive force to close the temple stabilizers. This could be uncomfortable for the patient or damage the stabilizers.</i> • <i>Forcing the patient in or out could also damage the stabilizers.</i>

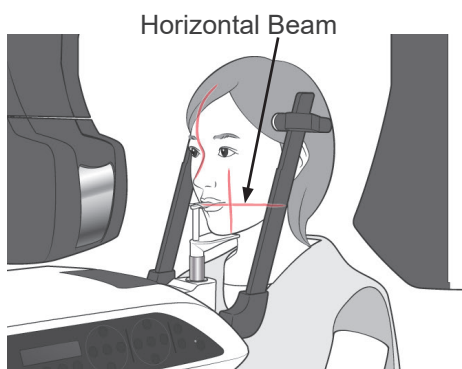
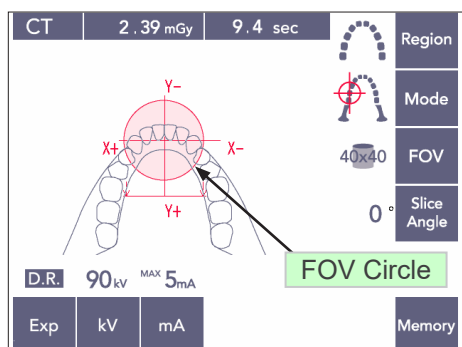
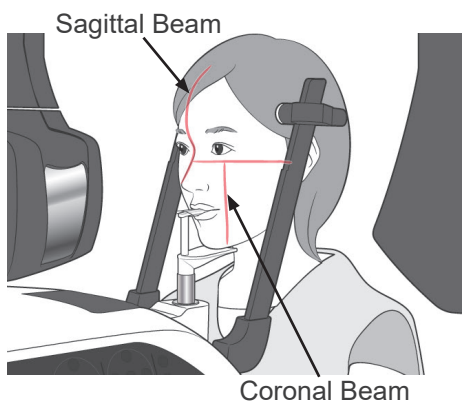
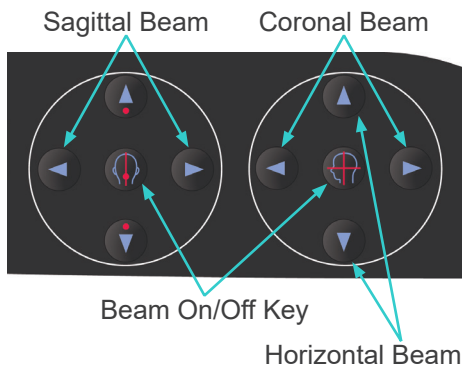

- Line up the sagittal beam with the patient's mid-sagittal plane.
And line up the coronal beam with the distal side of the upper left canine.

Usage Note

- If the unit is not in Ready mode, the coronal beam will not light up and its keys will not work.

WARNING

- The laser beams could damage the eyes. Do not stare into the positioning beams. Warn the patient not to look at the positioning beams.
- Have the patient close his eyes during positioning.

- Hold down the CT key for about 1 second until a two-toned beep sounds.
The FOV circle will appear in the display with its center aligned with the center of the incisor area. This shows the approximate area of the exposure.

- Move the coronal beam and sagittal beam to change the position of the FOV circle.

- For a 40x40 exposure, move the horizontal beam up or down to set the vertical position.
The exposure region has a height of 40 mm and the horizontal beam indicates the center of the region.

- To make a Height 80 or 50 exposure, the horizontal beam cannot be adjusted.

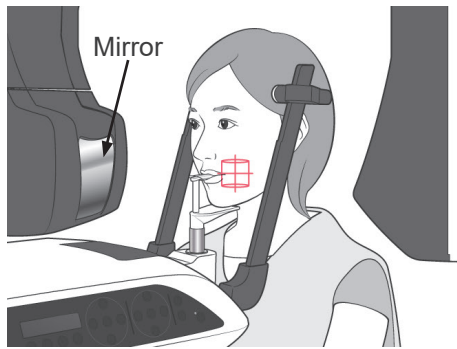

- 8) The center of the exposure is where the beams cross. Move the sagittal and coronal beams to the center of the exposure region. The exposure region has a diameter of 40 mm. Make sure the beams pass through the center of the exposure region. The FOV circle in the display shows only the approximate exposure area. Carefully check the beams to make the final adjustments for positioning.

* If the exposure region is on the patient's right, use the mirror on the arm to check the beams.

Usage Note

- ◆ *The FOV circle in the display is only a rough guide to positioning and cannot be relied on for accuracy.*

9) Double-Ready*¹ Function

*¹ The Double-Ready function is not enabled by default. To enable the Double-Ready function, contact your local dealer or J. MORITA OFFICE.

Press the Ready key again after completing patient positioning.

A two-toned beep will sound and the arm will move to its exposure start position.

The Ready LED will stay on and the Coronal beam will go out.

- In the Double-Ready*¹ mode, X-ray emission starts as soon as the emission button is pressed.
- In the Double-Ready*¹ mode, other operation keys and switches are disabled except for the Ready key and Lift keys.
- In the Double-Ready*¹ mode, press the Ready key again to return to the patient positioning Ready mode.

Usage Note

- ◆ *If the patient moves out of position after the unit is set for Double-Ready*¹, press the Ready key again to return the unit to its normal Ready setting and re-position the patient.*

(6) X-ray Emission

- 1) Check the arm operation panel, patient frame or control box, and make sure the green Ready LED is on.



Ready LED



Ready LED

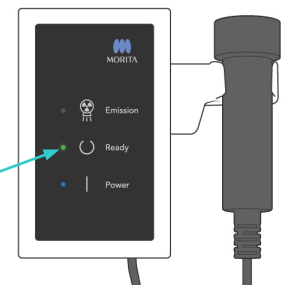

Ready LED

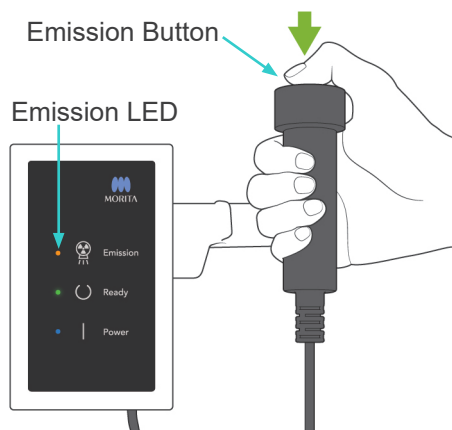

- 2) Pick up the handswitch and hold down the emission button. After a few seconds the secondary slit will start to move and X-rays will be emitted. During X-ray emission, the yellow Emission LED on the control box will light up and an audible signal will sound.

Usage Note

- ◆ It could take up to 15 seconds for emission to begin after the emission button is pressed. This is because the computer is confirming the settings on the X-ray unit and is not a malfunction.

- 3) Keep holding the emission button down. X-ray emission and arm rotation will stop after about 10 seconds. The Emission LED will go out, and the audible signal will stop. The arm will go to the patient egress position and the Ready LED will go out. Then the Ready LED will change to amber and start blinking to show that the image is being transmitted. After transmission is completed, the Ready LEDs on the arm and control box will change back to green and blink on and off.

⚠ WARNING

- Always leave the X-ray booth, and press the emission button outside of it.
- In case of an emergency, release the emission button; this will completely stop the unit.
- If, for some reason, the operator must stay in the booth during X-ray emission, he should stay at least 2 meters away from the unit and wear an X-ray protection apron with thyroid collar. He should stay out of the X-ray beam.

⚠ CAUTION

- Warn the patient not to move during emission (while the melody is sounding). If the patient moves, he could be hit by the arm or the image might be ruined.
- Hold the emission button down until the exposure is completed. If you let go of the button during the exposure, the arm will stop and the exposure will be aborted. To make another exposure, first carefully guide the patient away from the X-ray unit and then return the apparatus to its patient entry position. If the X-ray head or the detector is in back of the patient, turn the unit off and then carefully rotate the arm manually before guiding the patient away from the unit. If you perform the Ready procedure before guiding the patient away from the unit, the arm could hit the patient and cause an injury.
- If an error occurs during emission, the arm will stop and the exposure will be aborted. Carefully guide the patient away from the unit. If the X-ray head or the detector is in back of the patient, turn the unit off and then carefully rotate the arm manually before guiding the patient away from the unit. If you perform the Ready procedure before guiding the patient away from the unit, the arm could hit the patient and cause an injury.
- To perform a positioning method other than the Frankfurt plane method, the arm could hit the patient during the exposure if his head has been moved back a little. Pay attention to this point when performing a positioning method. If the patient has a large head, set the unit for "No X-ray", and do a dry run to visually check that there is no chance of the arm hitting the patient.



4) Hang the handswitch back in its holder.

- * If X-ray emission does not start when you press the emission button, check to see if the computer is busy reconstructing and image or asking for instructions.

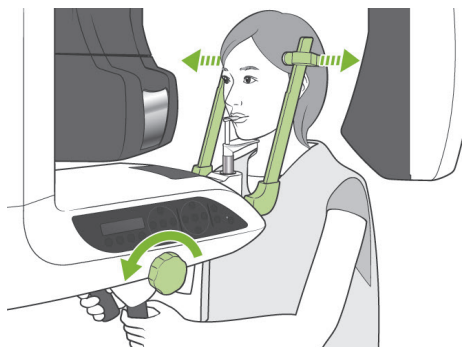

(7) Patient Egress and Image Transmission

- 1) After the exposure, the arm will automatically go to the patient egress position. Open the temple stabilizers all the way up and guide the patient away from the unit. Then close the stabilizers all the way.

⚠ WARNING

- *Never use excessive force to move the patient away; this could injure the patient or damage the stabilizers.*
- *Take care that the stabilizers do not strike the patient in the eye.*

- * When the arm is in the patient egress position after the completion of an exposure, press the Ready key on the arm operation panel to move it to its patient entry position.

⚠ CAUTION

- *Do not turn off the main switch until image transmission has completed. This will cause the image to be lost and the computer to freeze.*

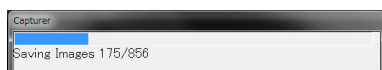

Transmitting Image

Usage Note

- ◆ *After image transmission, a two-toned beep will sound. However, another exposure cannot be made until the image appears in the computer's display.*
- ◆ *During image transmission, pressing the emission button will result in a series of beeps, but X-rays cannot be emitted.*
- ◆ *Some vertical or horizontal lines may appear during image acquisition. These are due to discrepancies in pixel sensitivity and are not a sensor malfunction.*
- ◆ *Refer to the user's guide for the i-Dixel application for details about software operation.*

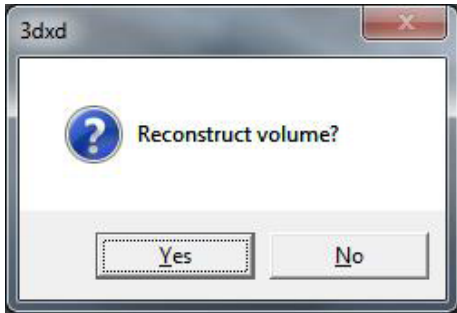

2) The dialogue box show to the left will appear after transmission has been completed.

* Image reconstruction takes about 5 minutes. (Click "No" if you wish to make another exposure right away.)

Click "Yes" to reconstruct the image and create the slices. After this is completed, the CT Task will be saved on the hard disk. The "CT Task" is the basic data needed to create 3D images and slices.

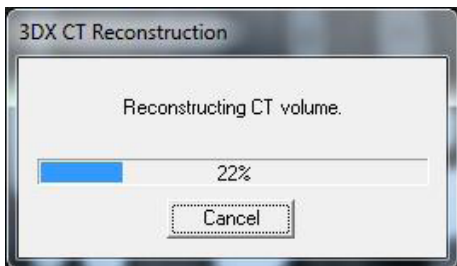

3) A progress bar appears while the image is being reconstructed.

Usage Note

◆ *CT Tasks require a lot of hard disk space and should be deleted periodically.*

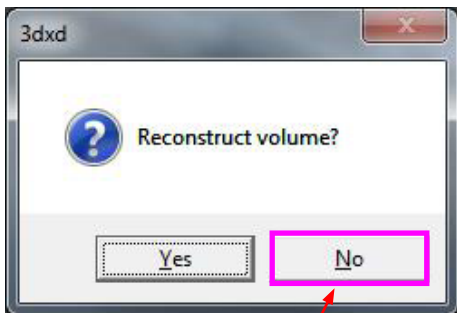

* If, for some reason, the exposure was stopped before it was finished, the CT image will not be complete. In this case, click No and then press the Ready key. The arm will go to its Start position and you can repeat the exposure.

(8) Panorama Scout

You can select the CT exposure region using the panorama scout in the computer monitor.

The Panorama Scout can only be used for the dental arch CT; 40×40 and 40×80.

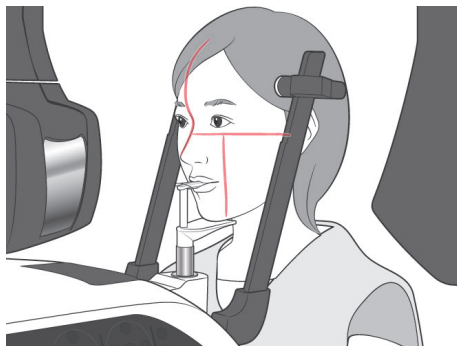
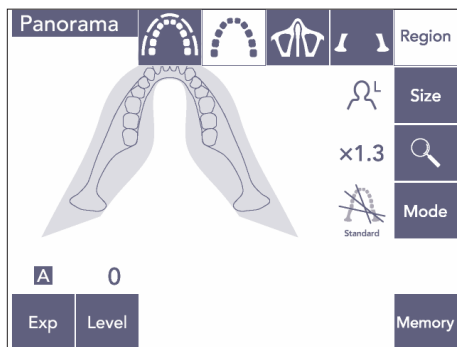
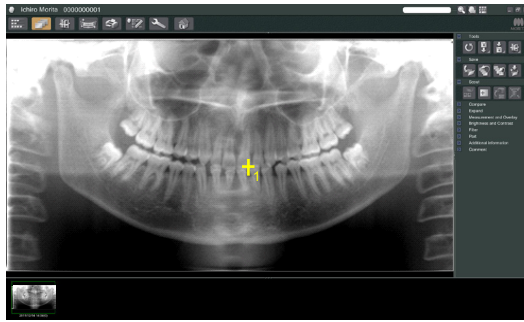

- 1) Perform patient positioning for a CT exposure as described on pages 75 and 76. Make sure the sagittal beam is aligned with the patient's mid-sagittal plane and the coronal beam with distal edge of the upper left canine.

CAUTION

- For a Panorama Scout exposure use as little x radiation as possible so that it will not influence the CT position.
- Warn the patient not to move during the Scout exposure and the following CT exposure.
- For an edentulous patient using the chin rest, it may not be possible to select the CT region on the panorama scout image if the coronal beam is 5 mm or more in front of its standard position. In this case, use beam positioning to make the CT exposure.

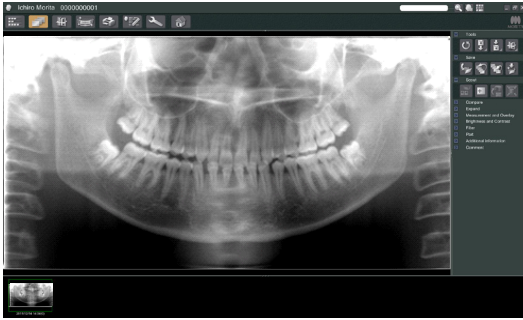

2) The panorama scout image will appear in the computer monitor.

⚠ CAUTION

- When you horizontally flip the panoramic image, the panoramic scout cannot be applied to it. Revert the image by flipping it back to the original. Also, do not use images with the conditions listed below for the panoramic scout. As these images do not contain horizontal flip information, the panoramic scout cannot be processed correctly.
- Imported panoramic images that have been horizontally flipped.
- Images that were horizontally flipped and saved as a new image by the i-Dixel software version 2.360 or earlier.

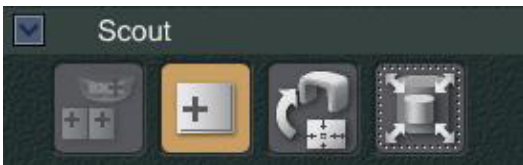

3) Click the Panorama Scout button: 

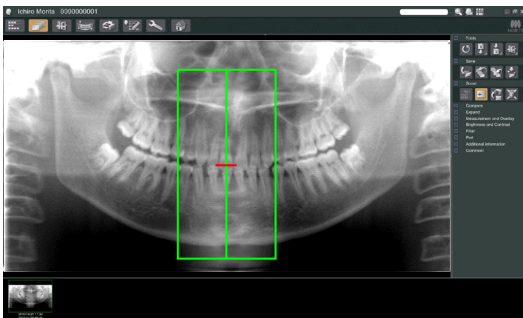

4) A green frame representing the CT exposure area will appear on the image. Drag the frame to the area for making the CT exposure.

* To change the size of the frame, click the CT Size button:  (See next page.)

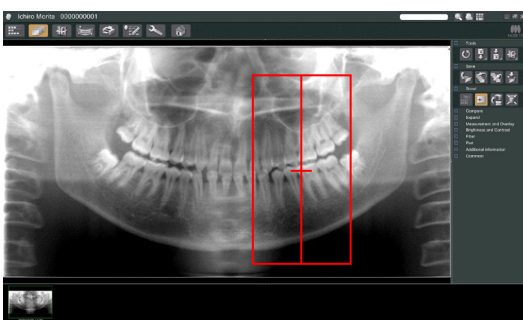
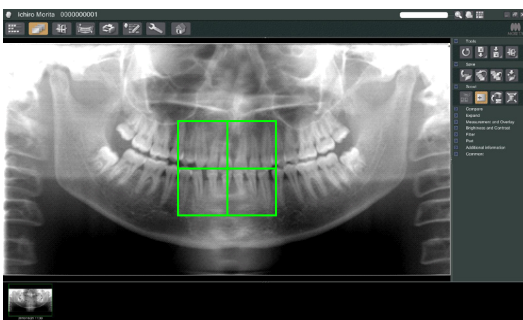

Usage Note

- ◆ Repeated clicking or dragging for a long time can slow down the computer's reaction or even freeze it.
- ◆ Do not press any keys on the arm or frame while the CT Size frame is being displayed. This could disable the unit.
- ◆ The frame for a 40×40 CT can move up or down as well as to the right or left. The 40×80 frame only moves to the left or right.
- ◆ If the color of the frame changes from green to red, it is outside the region where CT exposures can be made and cannot be used for positioning.

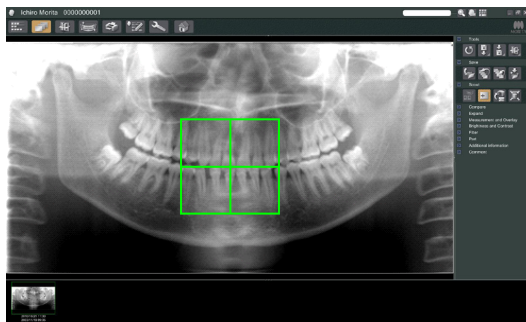
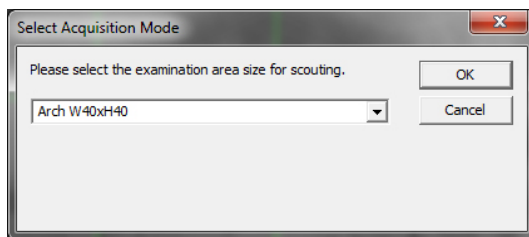
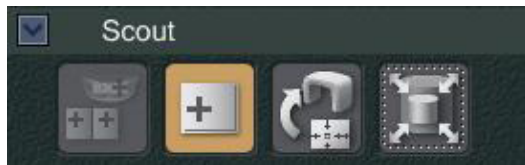

CT Area Size

Click the CT Size button to select 40×40 or 40×80

- 1) Click the CT Size button: 
A dialogue box will appear.

- 2) Click the triangle (▼) for the pull-down menu, select the size and then click OK.

- 3) You can also change the size by clicking inside the frame. A beep will sound and the size of the frame will change.

Usage Note

- ◆ The frame for a 40×40 CT can move up or down as well as to the right or left. The 40×80 frame only moves to the left or right.

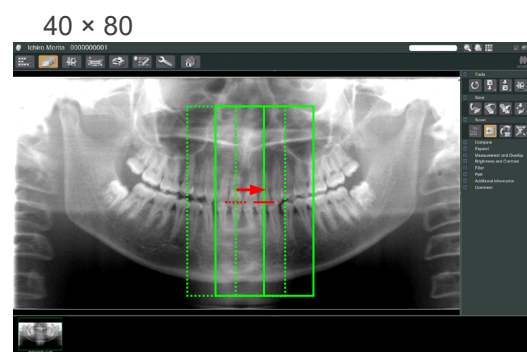
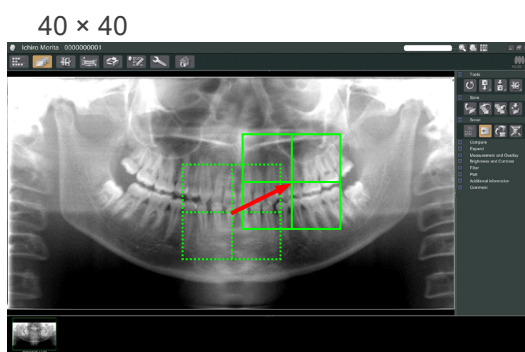



- Click the Transmit Scout button:  A plus (+) will appear in the panorama image showing the center of the exposure area.

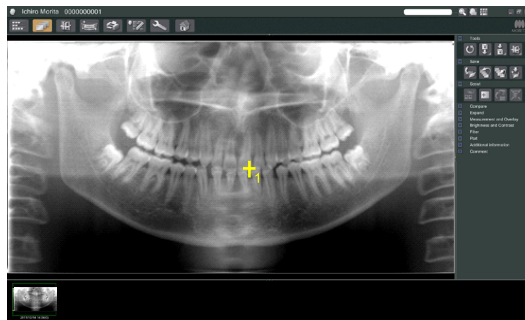

Usage Note

- Do not fail to click the Transmit Scout button after positioning the frame. If you do not click this button the frame will not represent the exposure area.
- When you horizontally flip the panoramic image, the panoramic scout cannot be applied to it. Be sure to select an image that has not been horizontally flipped, and specify the exposure area. For details, see page 84.
- If an error occurs for the X-ray unit, the error message shown below will appear and the scout data cannot properly transmitted.

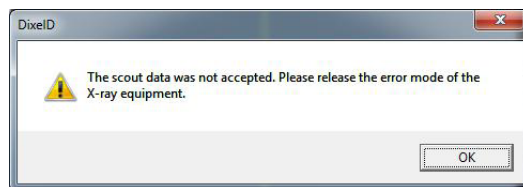

In this case, clear the error and press the Transmit Scout button again.

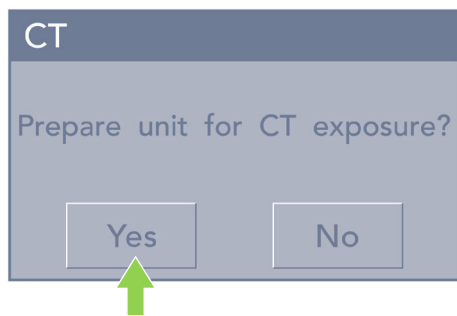

- If the selected area is OK, a two-toned beep will sound and the message shown to the left will appear in the operation panel. Press Yes to make the CT exposure. Press No to cancel the procedure.

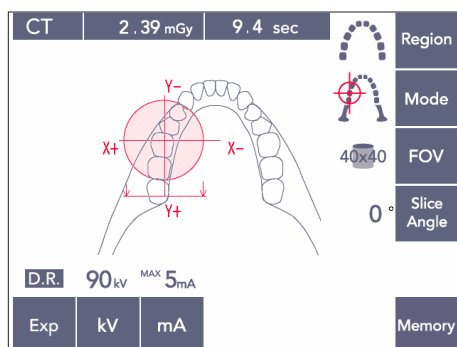

- The arm will go to its Start position and be ready to make an exposure. The exposure mode will automatically be set for CT. The selected FOV will appear in the arm operation panel.

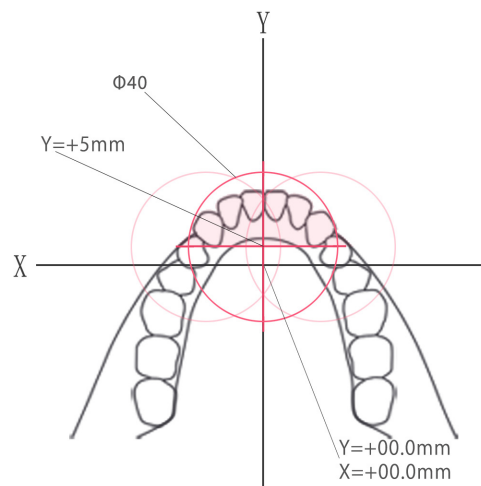

The Y axis cannot be set for a value greater than +5 mm. (This value appears in the frame display.)

However, if Y=+5 mm, the pink area in the diagram above will be within the exposure area. You can select the pink area with the scout frame even though it will not be in the center of the exposure. In this case, the frame will not change from green to red. However, the selected area will not be at the center of the exposure.

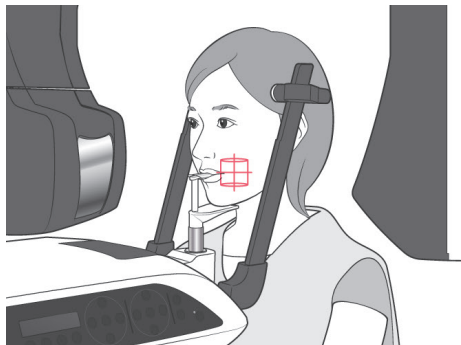

- 8) The center of the CT exposure area is the point where all three beams (coronal, horizontal, and sagittal) intersect.

Always check these beams to confirm the positioning. Use the beams to adjust the positioning.

- 9) Press the Ready key to put the unit into the Double-Ready*¹ mode.

*¹ The Double-Ready function is not enabled by default. To enable the Double-Ready function, contact your local dealer or J. MORITA OFFICE.

CAUTION

- *The panorama scout is not perfectly accurate. It is especially unsuitable for the lower molar region. Use the two-direction scout for this region.*

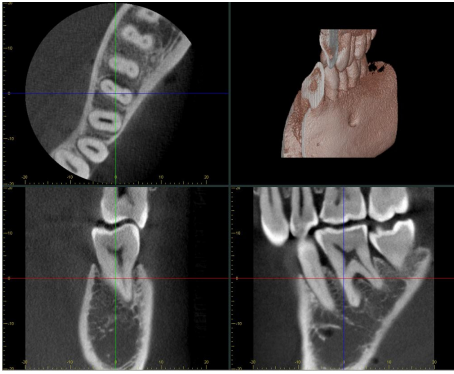

- 10) Refer to the instructions for CT X-ray emission in a previous part of this manual.
- 11) The CT images will appear in the computer screen after they have been reconstructed and the slices have been made. The CT images will be linked to the panorama scout image used to make them. Double clicking the plus mark in the panorama scout image will open the related CT images.

* When using the panorama scout, the slice angle of the resulting CT images will be aligned with the dental arch.

(9) Two-direction Scout

If the Two-direction Scout is selected, 2 images with different angles will appear in the computer monitor.

The arm and X-ray beam slit move automatically so that any point designated in the scout image will be in the center of the CT exposure.

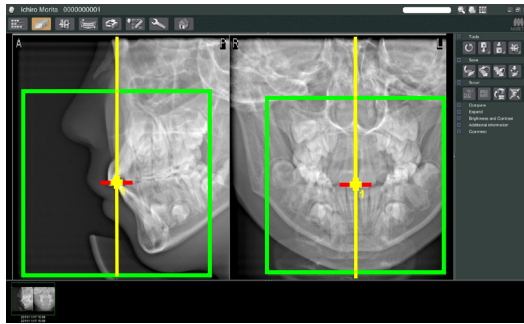

CAUTION

- Do not close the Two-direction Scout image until the CT image has been made. Closing the image will cancel the positioning.

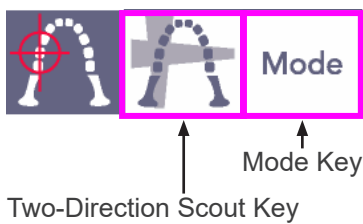
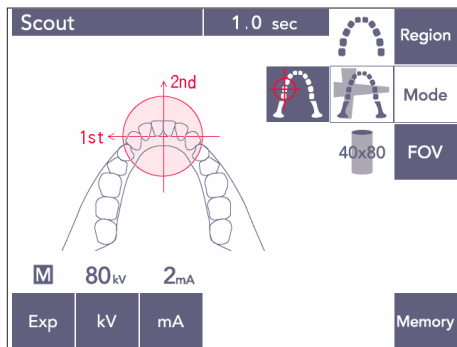

- Press the Mode key and then the two-direction scout key: 

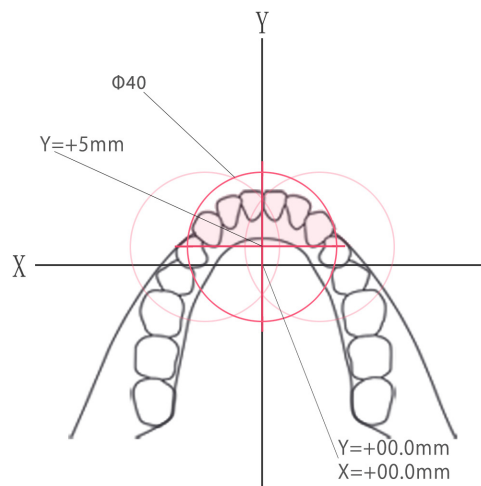

The Y axis cannot be set for a value greater than +5 mm. (This value appears in the frame display.)

However, if Y=+5 mm, the pink area in the diagram above will be within the exposure area. You can select the pink area with the scout frame even though it will not be in the center of the exposure. In this case, the frame will not change from green to red. However, the selected area will not be at the center of the exposure.

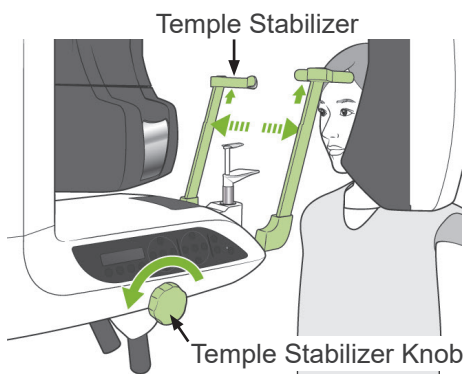

- 2) Have the patient wear an X-ray protection apron with thyroid collar, open the temple stabilizers, and then guide the patient into position.

⚠ WARNING

- *Take care that the temple stabilizers do not strike the patient in the eye.*

⚠ CAUTION

- *Have patients remove glasses, necklaces, earrings and other accessories which could interfere with diagnosis.*

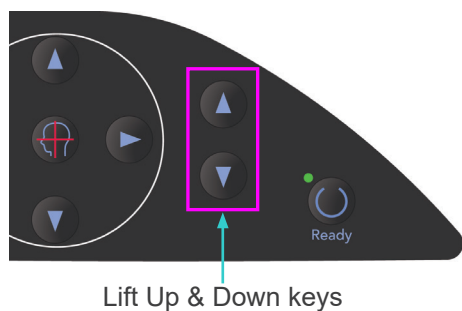

- 3) Adjust the lift to the patient's height with the Lift Up and Down keys.

⚠ CAUTION

- Keep fingers away from gaps for moving parts such as the temple stabilizers as well as the holes on the support column.

Usage Note

- ◆ Always use the Up and Down Keys to move the Lift. Never try to force it; this would damage it.
- ◆ An excessive load will activate the protection circuit. The lift will stop and an audible signal will sound. "Lift Overload" will appear in the frame's display for about 2 seconds and then disappear.

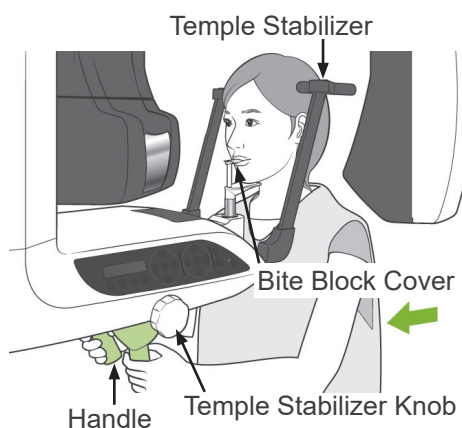

- 4) Have the patient stand straight, move forward and lightly take the bite block in his mouth and then set his chin on it. Have him grip the handles and lower his shoulders. Close the temple stabilizers until they lightly contact the patient's head.

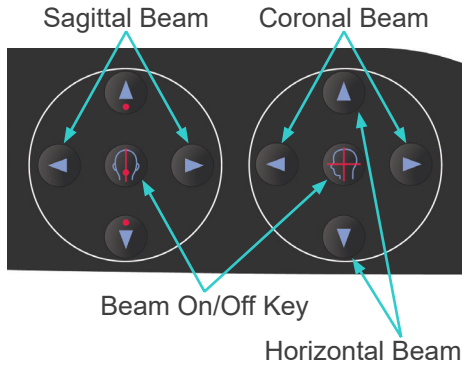

- 5) Make sure the sagittal and coronal beams are lined up with center of the exposure area as nearly as possible.
If these beams are too far off the Two-direction Scout may not work properly.

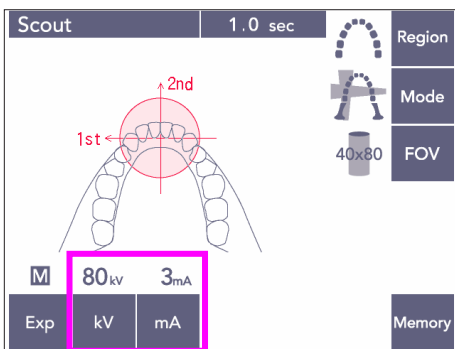

- 6) Set the kV and mA for the Two-direction Scout.

⚠ CAUTION
<ul style="list-style-type: none"> • For a Two-direction Scout exposure use as little x radiation as possible so that it will not influence the CT position.

(10) X-ray Emission

- 1) Check the arm operation panel, patient frame or control box, and make sure the green Ready LED is on.



Ready LED



Ready LED

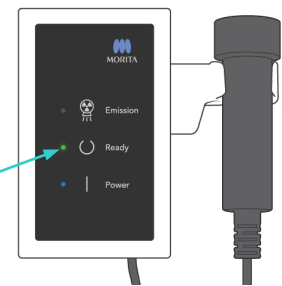

Ready LED

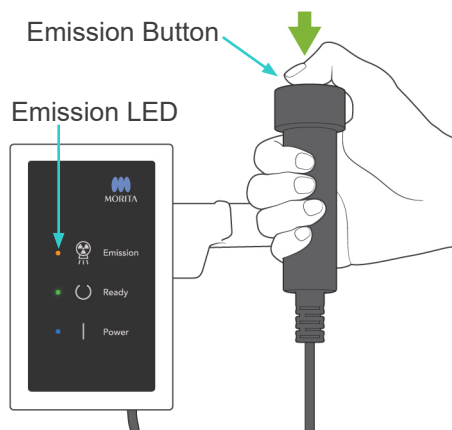

- 2) Pick up the handswitch and hold down the emission button. The arm will start to move and X-rays will be emitted. During X-ray emission, the yellow Emission LED on the control box will light up and an audible signal will sound. Keep holding the emission button down. The unit will make two exposures. Hold the button down until both exposures are completed.

Usage Note

- ♦ *It could take up to 15 seconds for emission to begin after the emission button is pressed. This is because the computer is confirming the settings on the X-ray unit and is not a malfunction.*

CAUTION

- *If you let go of the button before both exposures are completed, the scout image will not be made. In this case, press the Ready key and repeat the scout exposure.*

WARNING

- *Always leave the X-ray booth, and press the emission button outside of it.*
- *In case of an emergency, release the emission button; this will completely stop the unit.*
- *If, for some reason, the operator must stay in the booth during X-ray emission, he should stay at least 2 meters away from the unit and wear an X-ray protection apron with thyroid collar. He should stay out of the X-ray beam.*

⚠ CAUTION

- Warn the patient not to move during emission (while the melody is sounding). If the patient moves, the image might be ruined.
- Hold the emission button down until both exposures are completed. Releasing it after only one has been made will result in losing the first exposure and not getting any image at all.

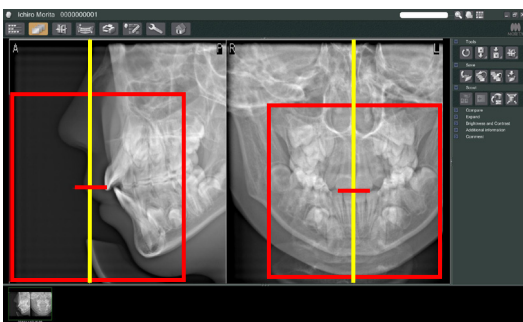
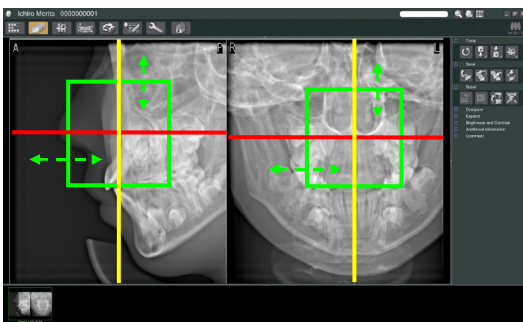
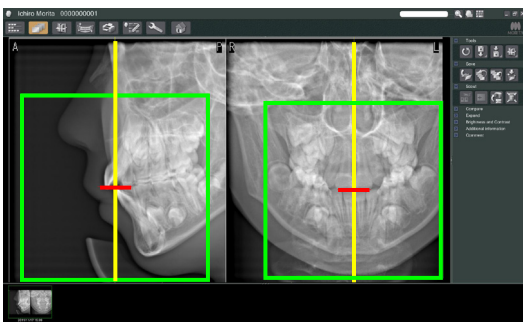

3) The two scout images will appear in the computer monitor. The intersection of the red and yellow lines shows the center of the exposure area and the green frame shows the size of the FOV. Drag the frame to set the center of the exposure.

* To change the size of the frame, click the CT Size button:  See page 85.

Usage Note

- ◆ Repeated clicking or dragging for a long time can slow down the computer's reaction or even freeze it.
 - ◆ Do not press any keys on the arm or frame while the CT Size frame is being displayed. This could disable the unit.
 - ◆ If the color of the frame changes from green to red, it is outside the region where CT exposures can be made and cannot be used for positioning.
 - ◆ The frame for a 40×40 CT can move up or down as well as to the right or left. The frame for other than the 40×40 CT only moves to the left or right.
- * Refer to page 85 for how to change the size of the FOV.



- 4) Click the Transmit Scout button: 
 A plus (+) will appear in the panorama image showing the center of the exposure area.

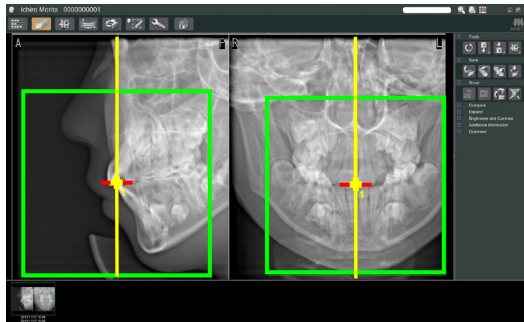

Usage Note

- ◆ Do not fail to click the Transmit Scout button after positioning the frame. If you do not click this button the frame will not represent the exposure area.
- ◆ If an error occurs for the X-ray unit, the error message shown below will appear and the scout data cannot properly transmitted.

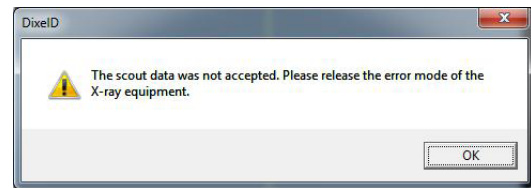

In this case, clear the error and press the Transmit Scout button again.

- * For FOV 100×50 and FOV100×80 CT exposures, a dotted line appears to show the maximum limit of the imaging area. Use this line to set the CT exposure area.

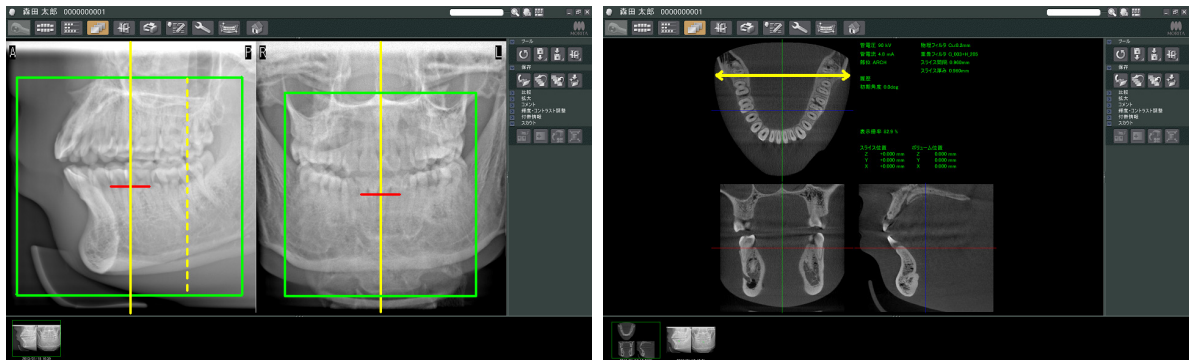

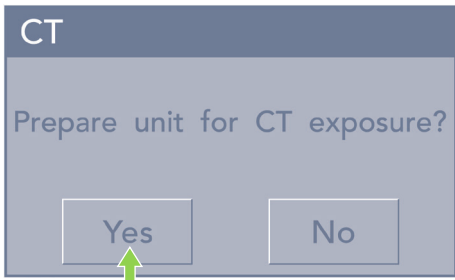

- 5) If the selected area is OK, a two-toned beep will sound and the message shown to the left will appear in the operation panel. Press Yes to make the CT exposure. Press No to cancel the procedure.

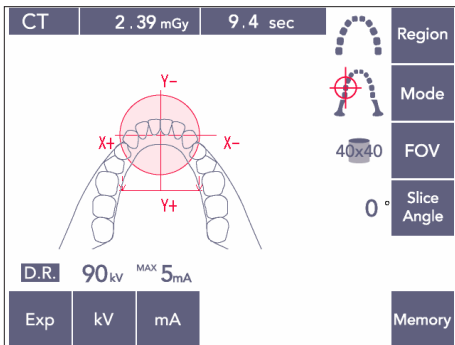

- 6) The arm will go to its Start position and be ready to make an exposure. The exposure mode will automatically be set for CT. The selected FOV circle will appear in the arm operation panel.

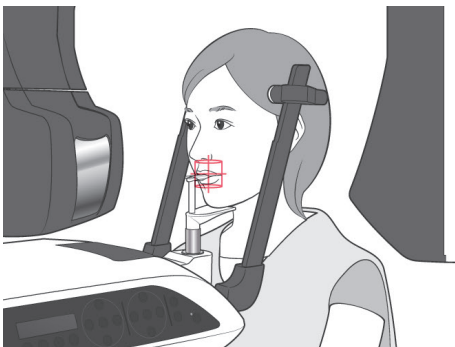

- 7) The center of the CT exposure area is the point where all three beams (coronal, horizontal, and sagittal) intersect. Always check these beams to confirm the positioning. Use the beams to adjust the positioning.

- 8) Press the Ready key to put the unit into the Double-Ready*¹ mode.

*¹ The Double-Ready function is not enabled by default. To enable the Double-Ready function, contact your local dealer or J. MORITA OFFICE.

- 9) The CT exposure will now start.

(11) Dental Arch CT Exposures

- * The 100 mm equivalent size will capture almost the entire dental arch.

CT Exposure Sizes

- Diam. 80 × Height 50 mm
- Diam. 80 × Height 80 mm
- Diam. 100 equivalent × Height 50 mm
- Diam. 100 equivalent × Height 80 mm

(11)-1 Set CT Exposure Mode

Press the CT key on the arm operation panel.

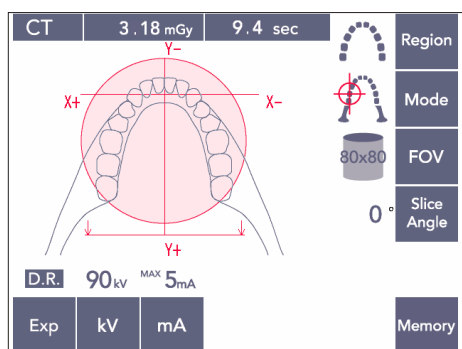

80×80 Dental Arch CT

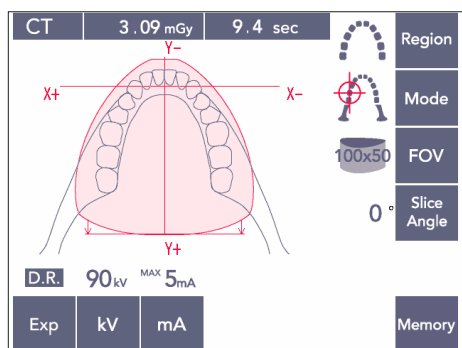

100×50 Dental Arch CT

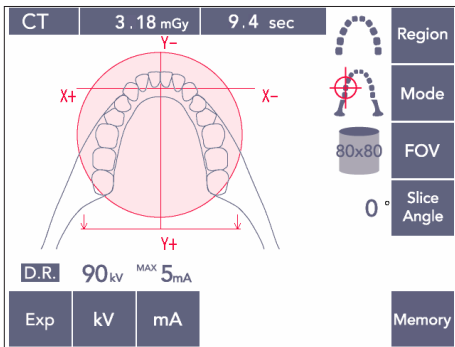

(11)-2 Region and FOVs

- 1) There is only one dental arch region available.
- 2) For FOVs 80x80 and 80x50, exposure of the molar regions is not possible. However, for FOVs 100x80 and 100x50, the entire dental arch will be enclosed.

Usage Note

- ◆ The entire dental arch may not fit into the exposure if the patient has an exceptionally large jaw.

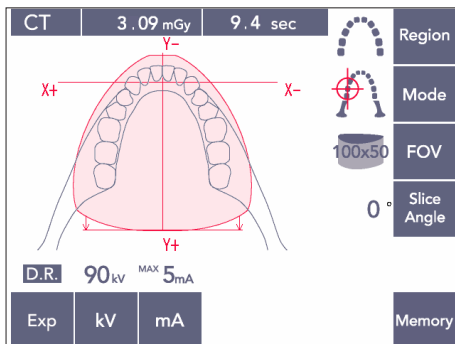

Usage Note

- ◆ The TMJ region cannot be selected for FOVs 80x50, 80x80, 100x80, and 100x50.

(11)-3 Exposure Conditions

- * CT exposures cannot be made using Auto exposure.
- * Set the exposure for No X-ray to make sure the arm will not hit the patient or perform other tests without emitting X-rays.

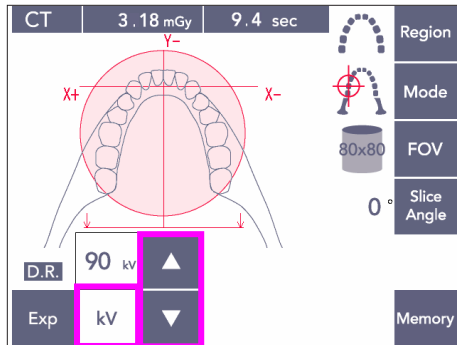

Press the kV key and adjust the value with the Up and Down keys.

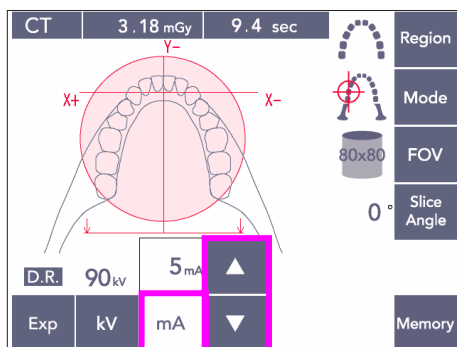

Press the mA key and adjust the value with the Up and Down keys.

- * Recommended settings: 90kV and 3 to 5 mA



Check that all settings are correct, and then press the Ready key.

Dose Reduction (D.R.) Exposure

X-ray dose is reduced by lowering the tube current for areas with greater X-ray transparency and is only 60% compared to using a fixed value for tube current. It also improves image quality for jaw and cheek outlines by reducing the load on the X-ray detector.

- * See page 74 for details.

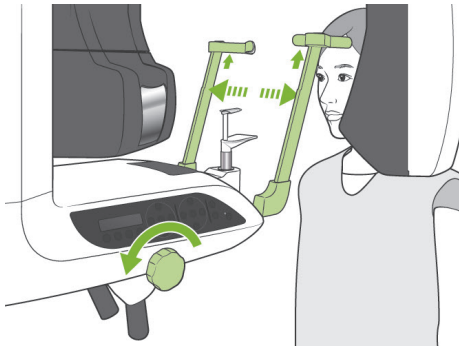

(11)-4 Patient Positioning

- 1) Have the patient put on an X-ray protection apron with thyroid collar. Open the temple stabilizers and have the patient step up to the unit.

WARNING

- *A new, uncontaminated bite block cover must be used for each patient to prevent from cross-contamination.*
- *Take care that the temple stabilizers do not hit the patient in the eye.*

CAUTION

- *Have the patient remove glasses, ear rings, and other accessories. These could ruin the image.*

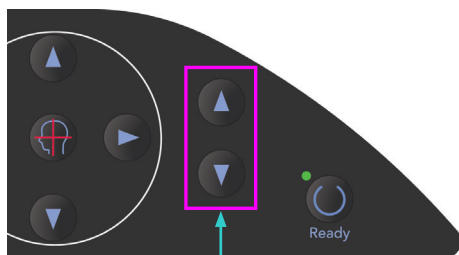

Lift Up & Down keys

- 2) Use the Up and Down keys to match the lift with the height of the patient.

CAUTION

- *Keep fingers away from gaps for moving parts such as the temple stabilizers as well as the holes on the support column.*

Usage Note

- ◆ Always use the Up and Down Keys to move the Lift. Never try to force it; this would damage it.
- ◆ An excessive load will activate the protection circuit. The lift will stop and an audible signal will sound. "Lift Overload" will appear in the frame's display for about 2 seconds and then disappear.

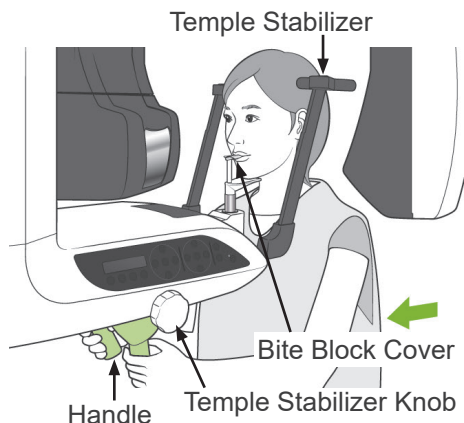

- 3) Have the patient stand straight, move forward and lightly take the bite block in his mouth and then set his chin on it. Have him grip the handles and lower his shoulders. Close the temple stabilizers until they lightly contact the patient's head.

⚠ CAUTION

- Do not use excessive force to close the temple stabilizers. This could be uncomfortable for the patient or damage the stabilizers.
- Forcing the patient in or out could also damage the stabilizers.

* A part of the bite block will appear in the image.

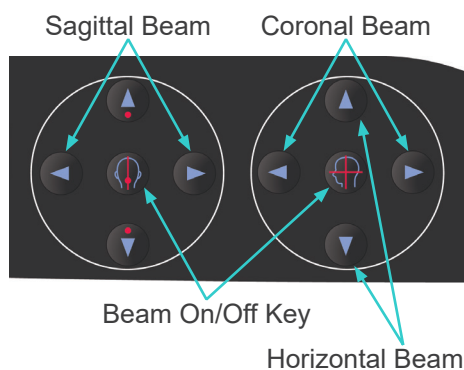

- 4) Line up the sagittal beam with the patient's mid-sagittal plane.

Usage Note

- ◆ If the unit is not in Ready mode, the coronal beam will not light up and its keys will not work.

⚠ WARNING

- The laser beams could damage the eyes. Do not stare into the positioning beams. Warn the patient not to look at the positioning beams.
- Have the patient close his eyes during positioning.

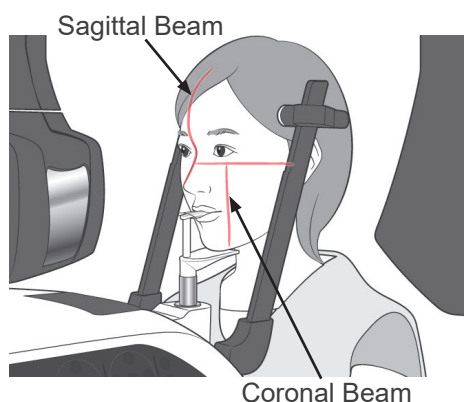

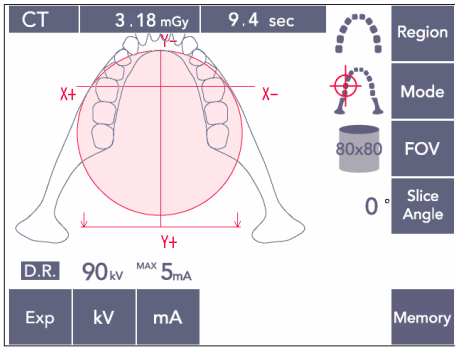

5) The illustration to the left is for the FOV 80×80.

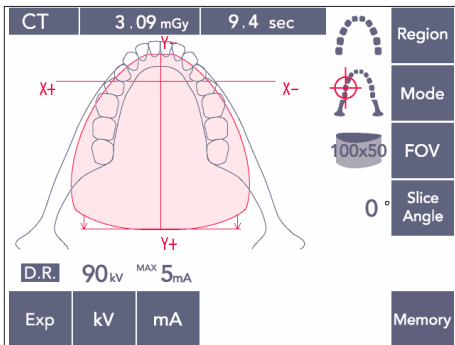

The illustration to the left is for the FOV 100×50.

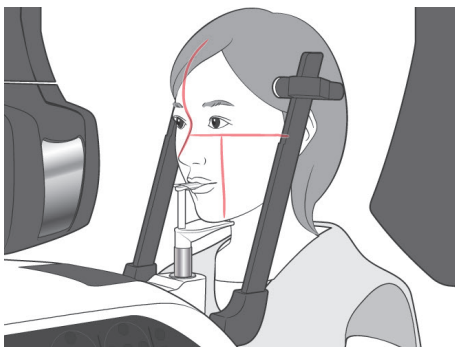

6) Now perform manual positioning. Line up the coronal beam with the distal side of the upper left canine. Hold down the CT key for about 1 second. The FOV circle will appear in the display. The front edge of the FOV will be about 20 mm in front of the coronal beam, and the entire dental arch will be enclosed by a FOV 80 or 100. The FOV circle approximately represents the horizontal plane.

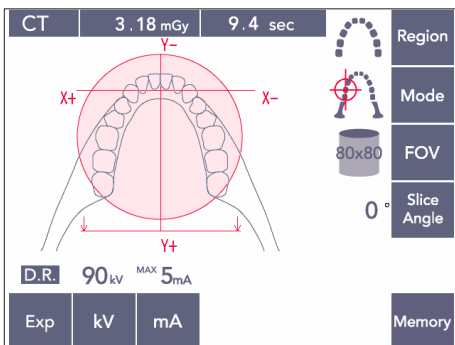

Usage Note

- ◆ *The arm could brush the patient's shoulder for the FOV 100 depending on how big the patient is. This contact will be less using the FOV 80.*

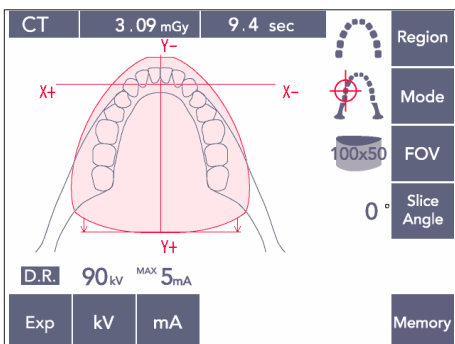

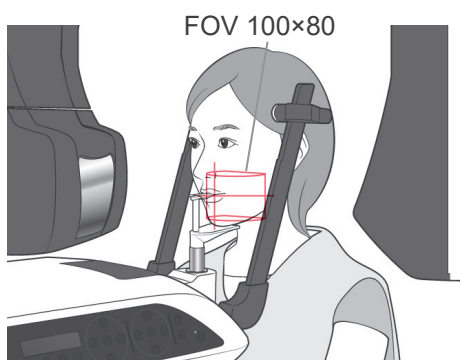
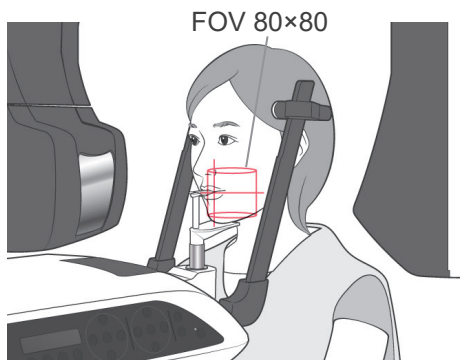

- 7) When the bite block is set in its High position, the occlusal plane is roughly at mid-height for the FOVs 80×80 and 100×80. If necessary, this can be adjusted by changing the height of the bite block. Move the coronal beam or the sagittal beam to shift the center of the FOV.

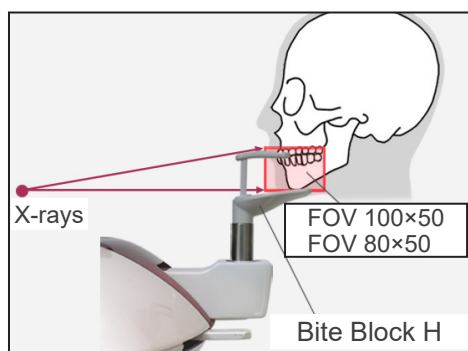

Vertical Adjustment

When the bite block is set in its High position, the FOV is set for the mandibular area for the FOVs 100×50 and 80×50. This cannot be adjusted by using the horizontal beam. If the target is not within this area, raise or lower the bite block to make a vertical adjustment.

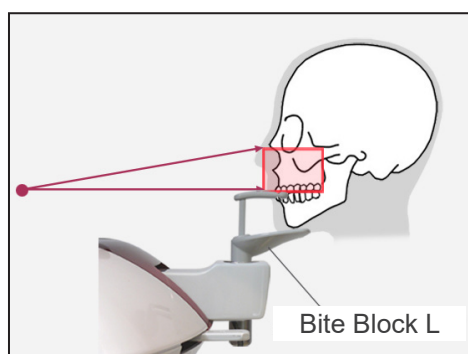

Usage Note

- ◆ The horizontal beam indicates the center height of the FOV. Use the horizontal beam as reference to make the occlusal plane as level as possible.

8) Double-Ready*¹ Function

*¹ The Double-Ready function is not enabled by default. To enable the Double-Ready function, contact your local dealer or J. MORITA OFFICE.

Press the Ready key again after completing patient positioning.

A two-toned beep will sound and the arm will move to its exposure start position.

The Ready LED will stay on and the Coronal beam will go out.

- In the Double-Ready*¹ mode, X-ray emission starts as soon as the emission button is pressed.
- In the Double-Ready*¹ mode, other operation keys and switches are disabled except for the Ready key and Lift keys.
- In the Double-Ready*¹ mode, press the Ready key again to return to the patient positioning Ready mode.

Usage Note

- ◆ *If the patient moves out of position after the unit is set for Double-Ready*¹, press the Ready key again to return the unit to its normal Ready setting and re-position the patient.*
- ◆ *Make sure the temple stabilizers are closed before pressing the Ready key. Otherwise, the arm might hit them.*

(11)-5 X-ray Emission

- 1) Check the arm operation panel, patient frame or control box, and make sure the green Ready LED is on.



Ready LED



Ready LED

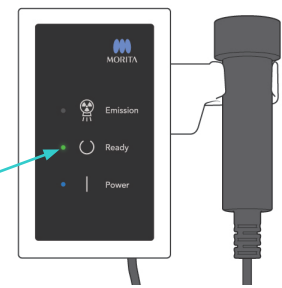

Ready LED

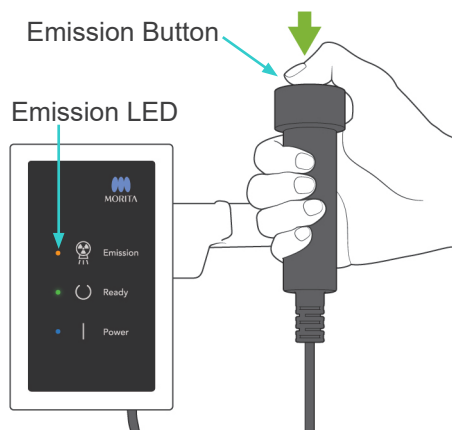

Emission Button

Emission LED

- 2) Pick up the handswitch and hold down the emission button. The arm will start to move and X-rays will be emitted. During X-ray emission, the yellow Emission LED on the control box will light up and an audible signal will sound.

Usage Note

- ♦ *It could take up to 15 seconds for emission to begin after the emission button is pressed. This is because the computer is confirming the settings on the X-ray unit and is not a malfunction.*



- 3) Keep holding the emission button down. X-ray emission and arm rotation will stop after about 10 seconds. The Emission LED will go out, and the audible signal will stop. The arm will go to the patient egress position and the Ready LED will go out. Then the Ready LED will change to amber and start blinking to show that the image is being transmitted. After transmission is completed, the Ready LEDs on the arm and control box will change back to green and blink on and off.

⚠ WARNING

- *Always leave the X-ray booth, and press the emission button outside of it.*
- *In case of an emergency, release the emission button; this will completely stop the unit.*
- *If, for some reason, the operator must stay in the booth during X-ray emission, he should stay at least 2 meters away from the unit and wear an X-ray protection apron with thyroid collar. He should stay out of the X-ray beam.*

⚠ CAUTION

- Warn the patient not to move during emission (while the melody is sounding). If the patient moves, the image might be ruined.
- Hold the emission button down until the exposure is completed. If you let go of the button during the exposure, the arm will stop and the exposure will be aborted. To make another exposure, first carefully guide the patient away from the X-ray unit and then return the apparatus to its patient entry position. If the X-ray head or the detector is in back of the patient, turn the unit off and then carefully rotate the arm manually before guiding the patient away from the unit. If you perform the Ready procedure before guiding the patient away from the unit, the arm could hit the patient and cause an injury.
- If an error occurs during emission, the arm will stop and the exposure will be aborted. Carefully guide the patient away from the unit. If the X-ray head or the detector is in back of the patient, turn the unit off and then carefully rotate the arm manually before guiding the patient away from the unit. If you perform the Ready procedure before guiding the patient away from the unit, the arm could hit the patient and cause an injury.
- To perform a positioning method other than the Frankfurt plane method, the arm could hit the patient during the exposure if his head has been moved back a little. Pay attention to this point when performing a positioning method. If the patient has a large head, set the unit for “No X-ray”, and do a dry run to visually check that there is no chance of the arm hitting the patient.



4) Hang the handswitch back in its holder.

* If X-ray emission does not start when you press the emission button, check to see if the computer is busy reconstructing and image or asking for instructions.

* If, for some reason, the exposure was stopped before it was finished, the CT image will not be complete. In this case, click No and then press the Ready key. The arm will go to its Start position and you can repeat the exposure.

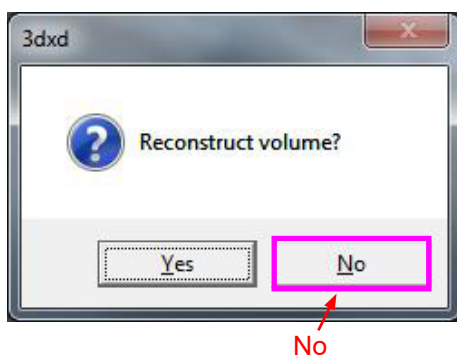

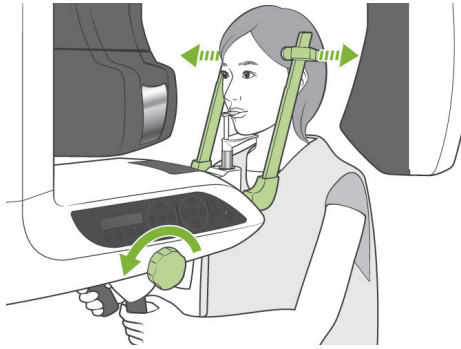

(11)-6 Patient Egress and Image Transmission

- 1) After the exposure, the arm will automatically go to the patient egress position. Open the temple stabilizers all the way up and guide the patient away from the unit. Then close the stabilizers all the way.

⚠ WARNING

- *Never use excessive force to move the patient away; this could injure the patient or damage the stabilizers.*
- *Take care that the stabilizers do not strike the patient in the eye.*

- * When the arm is in the patient egress position after the completion of an exposure, press the Ready key on the arm operation panel to move it to its patient entry position.
- * Throw away the bite block cover.

iii. After Use

(1) Turn main switch off.

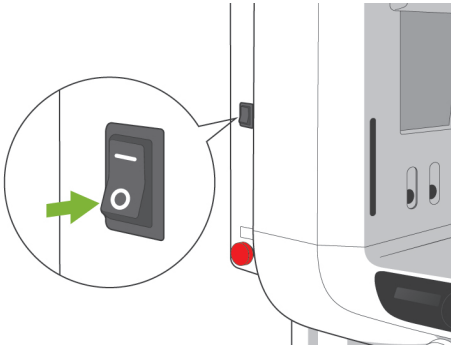

Press the bottom (○) of the main switch to turn the unit off. The Main LED will go out.

WARNING

- *Do not fail to turn the unit off after use; this will eliminate the risk of electrical leakage and accidents.*

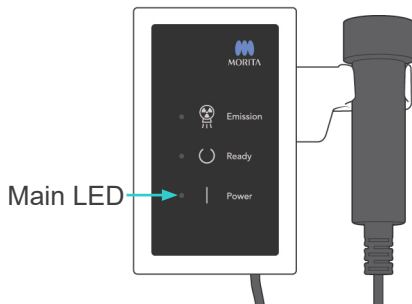

Maintenance, Parts Replacements, and Storage

1. Disinfection

(1) Regular Maintenance

- Disinfect the Temple Stabilizers, Ear Rods, the Chin Rest, the Bite Block, the Nasion Plate, the Lip-nose Rest, the Patient Handles etc. after each patient by wiping them with Ethanol (70 vol% to 80 vol%).
If it is not possible to obtain Ethanol (70 vol% to 80 vol%), use one of the disinfectants listed below; do not use any other type of disinfectant.
 - DÜRR DENTAL's FD 322 quick disinfectant
 - DÜRR DENTAL's FD 333 quick disinfectant
 - DÜRR DENTAL's FD 360 imitation leather cleaning and care
 - DÜRR DENTAL's FD 366 sensitive Rapid disinfection
- Wipe the operation panel with Ethanol (70 vol% to 80 vol%).
- Every 6 months, inspect and grease the wire cables for the lift.

WARNING

- *Always turn the main switch off before performing maintenance. This will eliminate the risk of shocks, burns, and accidental switch operation which could result in an injury.*

Usage Note

- ◆ *Use only Ethanol (70 vol% to 80 vol%) or a neutral detergent to clean outer surfaces. Never use alkaline or acidic solutions, cresol soap, or other chemical solutions; this could cause discoloration or degrade the materials.*
- ◆ *Dampen a soft cloth with Ethanol (70 vol% to 80 vol%) or a neutral detergent, and wring it out thoroughly. Make sure no liquid seeps inside; this could cause mechanical or other malfunctions.*
- ◆ *Use Ethanol (70 vol% to 80 vol%) to immediately wipe off any water, detergent or other chemicals that get on the outer surfaces.*
- ◆ *Do not directly spray Ethanol (70 vol% to 80 vol%), neutral detergent or water on the unit. Make sure no liquid seeps inside; this could cause mechanical or other malfunctions.*
- ◆ *Do not use ozone water to clean the unit. Ozone water could damage to the unit.*
- ◆ *Do not disinfect the clinic with ozone gas or ultraviolet light. This could damage plastic and rubber components.*
- ◆ *When cleaning, never pull on any cables or cords.*

2. Replacement Parts

- * Replace the parts listed in the Regular Inspection List as necessary depending on degree of wear and length of use. For details, see page 114 “Service Life, Consumables, and Replacement Parts”.
- * Order replacement parts from your local dealer or J. MORITA OFFICE.

3. Storage and Transportation

- * Keep the mouthpieces and the bite block covers in a clean, uncontaminated area.
- * If the unit has not been used for some time, make sure it works properly before using it again.

Regular Inspection

- Maintenance and inspection are generally consider to be the duty and obligation of the user. However, the user is unable to carry out these duties for some reason, they may be performed by the accredited service personnel. Contact your local dealer or J. MORITA OFFICE for details.
- This unit should be inspected for all the items in the following list once a year.
- At the start and end of each business day, make sure that switching the main switch to ON and OFF turns the equipment on or off without fail.
- The inspection items marked * may only be performed by the service personnel for further preventive inspection and maintenance during the life of the device.
- For repair or other types of service contact your local dealer or J. MORITA OFFICE.

Regular Inspection List

Power Supply and Physical Stability

1. Power Supply Voltage
 - * Use a digital or analog tester to measure the unit's power supply.
The result must be 120 V AC $\pm 10\%$ for EX-1, and 220/230/240 V AC $\pm 10\%$ for EX-2.
2. Ground connection
 - Visually inspection the ground connection to make sure it is securely and properly connected.
3. Floor and base securing bolts
 - Visually inspect the floor and base securing bolts.
Check that the floor is level and make sure the base bolts have not loosened up.
4. Bolt and screw tightness
 - Inspect all the bolts and screws on the unit.
Make sure that all bolts are in place and properly secured.
5. Electrical circuitry
 - Make sure all wiring and connections are intact. *Inspection of the wirings inside the enclosures may only be done by the accredited service personnel.
6. LAN cables
 - Make sure no cables are bent or pinched and that they are all securely connected.
7. Outer appearance and labels
 - Make sure outer covers and panels etc are not damaged, cracked, loose or dirty.
Make sure labels for rating, tube, and lasers are all properly in place and securely attached.
8. Main switch
 - Turn the main switch on and off and make sure the main LED on the control box lights up.
9. Emergency Stop Switch
 - Turn on the main switch and then press the emergency stop switch.
Check that the power goes off. (Main LED on the control box goes out.)
10. Patient Auto Positioning (AF)
 - Put a test object in place. Press the patient type keys and make sure the arm moves forward or backward. Repeat this test 3 times with the test object in a different position each time.
Make sure auto positioning sensor moves up and down smoothly.
11. Light Beams
 - Make sure the mid-sagittal, horizontal, coronal (both sides) and the sagittal plane beams light up and can be turned on and off. Also make sure that the horizontal, coronal (both sides) and the sagittal plane beams move smoothly.
12. Patient Handles
 - Make sure handles are tight and properly secured.

13. Temple stabilizers and chin rest

Turn the temple stabilizer knob to make sure the stabilizers open and close properly. Make sure the chin rest, lip-nose rest, and bite block are secure in both their upper and lower positions.

14. Lift Mechanism

Press the up and down keys.

Make sure the lift moves smoothly and stops properly. Repeat this 3 times.

15. Wire Cables

Check the wire cables for broken strands. Make sure the ends are properly secured.

Grease the cables with the grease provided by the manufacturer.

16. Operation panel and display

Press all the keys on the operation panel and display and make sure they work.

Press all the keys on the patient frame and make sure they work.

Make sure the LED on the control box lights up when the Ready key is pressed.

17. X-ray Emission and Display

Make sure the Emission LED (yellow) on the control box lights up during X-ray emission and that the audible signal sounds.

18. Oil Leak

Check for the oil leak, if the insulation oil filled in the tube head assembly in X-ray Head from the outside of the enclosure. * Oil leak check from the tube head assembly inside the enclosure may only be done by the accredited service personnel.

Panorama Exposures

1. X-ray emission and image read-in

Make an X-ray exposure of a test piece and check the resulting image in the computer monitor.

2. Arm Rotation

Hold down the emission button to rotate the arm.

Make sure it does not make an abnormal noise or slip and that it stops at the specified point.

3. Arm Emergency Stop

Make sure the arms stops when the emission button is released and when the emergency stop switch is pressed.

4. DDAE Verification

Cephalo Exposure (Cephalo option only)

1. X-ray Head changeover

Close the panorama temple stabilizers. Press either LA or PA cephalo and then the Ready key. Make sure the X-ray head turns around and that it and the arm automatically go into their cephalo positions.

Make the above operation is not performed when the panorama temple stabilizers are open even if the cephalo and Ready keys are pressed.

Repeat each procedure 3 times.

2. X-ray emission and image read-in

Make an X-ray exposure of a test piece and check the resulting image in the computer monitor.

3. Craniostat Movement

Move the craniostat up and down with the up and down keys. Make sure it moves smoothly and stops accurately. Repeat 3 times.

4. Secondary Slit

Press the Start Position key and the patient Entrance and Egress key and make sure the cassette holder and secondary slit move smoothly and stop accurately.
Repeat 3 times.

5. Craniostat

Grip the ear rod plates at their base with both hands and make sure they open and close smoothly and go securely into position.
Grip the nasion retainer at the base and make sure it moves to the left and right and up and down smoothly and goes securely into position.

6. Light Beam

Make sure the horizontal cephalo light beam can be turned on and off with its switch.

7. Cephalo Emergency Stop

Release the emission button while the cephalo sensor and secondary slit are moving and make sure they stop.

CT Exposure

1. X-ray emission and image read-in

Make an X-ray exposure of a test piece and check the resulting image in the computer monitor.

2. X-ray Slit

Make sure the X-ray beam irradiates the effective detect area of the flat panel detector.

3. Arm Rotation

Hold down the emission button and rotate the arm. Make sure it does not make an abnormal noise or slip and that it stops at the specified point.

4. Arm Emergency Stop

Make sure the arms stops when the emission button is released and when the emergency stop switch is pressed.

5. Quality Assurance Test

Quality Tests should be regularly performed to maintain the conditions for optimum imaging and X-ray safety of the equipment at least once every 6 months (once a month, recommended). The test procedure is described in the Quality Tests Procedure manual that is provided with the equipment.

Service Life, Consumables, and Replacement Parts

Service life refers to the standard period the unit or individual components can be expected to be usable as long as inspection and maintenance procedures specified by J. MORITA MFG. CORP. are followed.

Component Service Life List refers to components that can be expected to wear out, degrade or break depending on frequency and conditions of usage, which greatly affects how long these components retain their performance standards.

Consumables refer to parts and components that inevitably are degraded and need to be replaced periodically and are not covered by the warranty.

The product warranty is good for 3 years after delivery.

The components on the Component Service Life List that are noted "Yes" are critical for safety. These components must be inspected and replaced or have appropriate maintenance performed as necessary without fail before their standard service life expires.

The user must pay for parts and repairs that are performed after the warranty expires or the part has passed its specified service life. However, if a maintenance contract has been agreed to, this will depend on the contents of that contract.

For details concerning regular inspection and parts replacements, contact your local dealer or J. MORITA OFFICE.

Component Service Life List

Components	Standard Service Life	Critical Safety Component	Remarks
Moving Parts (for Arm and Lift)	45,000 exposures or 6 years whichever comes first	Yes	Including cables, bearings, etc.
Motors (for Arm and Lift)	45,000 exposures or 6 years whichever comes first	N/A	
X-ray Tube *1	15,000 exposures	N/A	
High Voltage Unit	3 years	N/A	
X-ray Detector *2	3 years	N/A	
Printed Circuit Boards	6 years	Yes	
LCD Display	6 years	N/A	
Touch Panel, Operation Switches	3 years	N/A	
Patient Handles	6 years	Yes	
Temple Stabilizers	3 years	N/A	
Ear Rod Plates	3 years	N/A	
Nasion Plate	3 years	N/A	

*1 The service life of the X-ray tube depends on the number and length of exposures it is used for as well as the output (tube voltage and current) and the time between exposures. Of these factors, the most critical is the number of exposures which degrades the anode. As the anode gradually degrades, stable output is lost, and the circuit protection system detects errors and terminates X-ray emission.

*2 The service life of the X-ray detector mainly depends on the ambient conditions (temperature and humidity) where it is used and the accumulated amount of X radiation it receives. As the accumulated amount of received X radiation increases, the sensitivity of the detector is gradually degraded. High humidity can also lead to degradation. Semiconductor degradation caused by X radiation and the disparities for individual semiconductor units can cause parts of the detector to lose sensitivity. Loss of sensitivity can be remedied to some degree by performing sensitivity compensation and calibration during regular inspections, but partial sensitivity degradation cannot always be corrected.

Consumable Parts

Components	Code No.	Exchange Frequency	Critical Safety Component	Remarks
Mouth Pieces (100)	6270763	Single use	Yes	For infection control
Bite Block Cover	6211120	Single use	Yes	For infection control
Chin Rest (RAL)	6213900	1 year or whenever scratched or damaged.	N/A	
Lip-nose Rest (RAL)	6213901	1 year or whenever scratched or damaged.	N/A	
Bite Block (RAL)	6213903	1 year or whenever scratched or damaged.	N/A	
Bite Block Assembly (RAL)	6213902	1 year or whenever scratched or damaged.	N/A	
Ear Rod	6290325	1 year or whenever scratched or damaged.	N/A	
Hand X-ray Plate (RAL)	6292400	1 year or whenever scratched or damaged.	N/A	
X550 2D/3D 3-piece Copper Filter (RAL)	6331001	Whenever scratched or damaged.	N/A	

Replacement Parts

Type	Code No.	Description	Rating	Type	Qu.
EX-1	6112442	Main Fuse	F25A 250V	Fast-acting, High Breaking Capacity Size: 0.25 × 1.25 inches	1
EX-2	6112473	Main Fuse	F12.5A 250F	Fast-acting, High Breaking Capacity Size: 5 × 20 mm	1
EX-1, 2	6310324	Power Board F2	F10A 400V	Fast-acting, High Breaking Capacity Size: 0.25 × 1.25 inches	1

Fuse shall be replaced by qualified person. The user should never replace the fuse himself.

CAUTION

*Some portion remains "live" even if the main switch is turned off.
Be sure to turn off the circuit breaker for EX-2 or unplug the power supply cord for EX-1 before servicing to avoid electrical shock.*

Service

The Veraviewepocs 3D may be repaired and serviced by:

- The technicians of J. MORITA's subsidiaries all over the world.
- Technicians employed by authorized J. MORITA dealers and specially trained by J. MORITA.
- Independent technicians specially trained and authorized by J. MORITA.

The circuit diagrams, component parts lists, descriptions, calibration instructions, or other information will be available on request, only for the service personnel authorized by J. MORITA to repair those parts.

Trouble shooting

If the equipment operation does not seem to be normal, check or adjust the following before requesting a repair service.

- ◆ If the equipment does not operate properly after the inspection, adjustment, or parts replacement or if you cannot perform the inspection yourself, contact your local dealer or J. MORITA OFFICE.
- ◆ The inside parts of the equipment are charged with high voltage. Do not attempt to perform maintenance or adjustment that is not described in the troubleshooting table.
- ◆ If an accident occurs, the equipment must not be used until repairs have been completed by a qualified and trained technician provided by the manufacturer.
- ◆ Before conducting the inspection or adjustment, confirm that the Main LED (blue) on the control box is lit.
- ◆ Contact your local dealer or J. MORITA OFFICE for repairs if the apparatus does not work normally even after performing the steps recommended below.

Main Unit		
Problem	Possible Cause	Remedy
No power when main switch is turned on.	No power supply	Check the breaker on the distribution panel.
	Emergency Switch has been pressed.	Release emergency switch and turn on main switch.
Switches don't work Arm doesn't go to starting point	Some function or process is in progress	<p>Wait a while. If normal operation is not restored, turned the unit off, wait 1 minute, and then turn it on again.</p> <p>* In the Double-Ready*¹ mode, other operation keys are disabled except for the Ready key. Press the Ready key.</p> <p>*¹ The Double-Ready function is not enabled by default. To enable the Double-Ready function, contact your local dealer or J. MORITA OFFICE.</p>

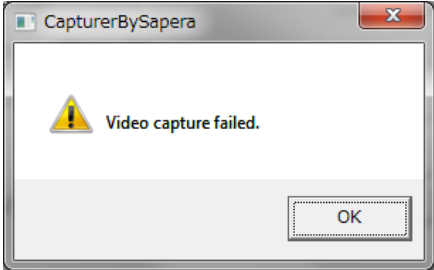
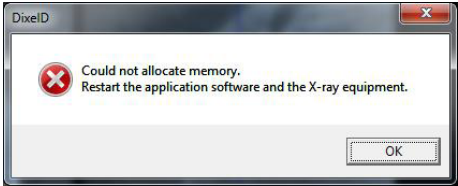
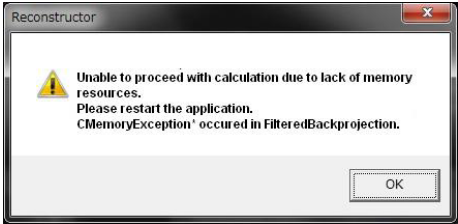
Computer Screen and Arm Display		
Problem	Possible Cause	Remedy
<p>Warning Messages</p> <p>In computer screen for CT images</p>  <p>(for CT exposure)</p> <p>In X-ray unit Arm Display</p> <p>The computer is not receiving the image. X-ray is terminated.</p>	<p>LAN cable transmission problem</p> <p>* LAN cable is not properly connected.</p>	<p>Reconnect and confirm LAN cable connection. Restart i-Dixel application.</p>
<p>If either of the following error messages appear in the i-Dixel computer screen</p>   <p>* If the above error messages appear the following message may appear in the Arm Display:</p> <p>Computer is not ready to capture images.</p>	<p>This happens when the computer runs out of memory due to repeated exposures and image reconstruction.</p>	<p>Restart i-Dixel application</p>

Computer Screen and Arm Display

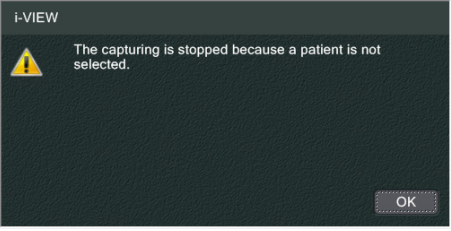
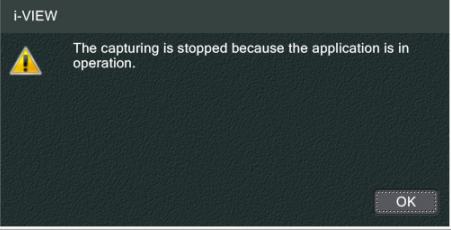
Problem	Possible Cause	Remedy
<p>Warning Messages</p> <p>In computer screen</p>  <p>In X-ray unit Arm Display</p> <p>Message Number : 30 Cannot establish communication with the driver software. The application software may not be ready, or busy processing data.</p>	<p>Exposure was initiated without selecting a patient page.</p>	<ul style="list-style-type: none"> • Close the message in the computer monitor and select a patient page. • Press the Ready key and then repeat the Ready procedure (press Ready key or emission button) • Make the exposure
<p>Warning Messages</p> <p>In computer screen</p>  <p>In X-ray unit Arm Display</p> <p>Message Number : 30 Cannot establish communication with the driver software. The application software may not be ready, or busy processing data.</p>	<p>Initiated exposure when software was not capable of processing a new exposure</p> <p>* i-Dixel message</p>	<ul style="list-style-type: none"> • Close the message in the computer monitor • Press the Ready key and then repeat the Ready procedure (press Ready key or emission button) • Make the exposure
<p>When clicking the Send CT Scout Position icon in the panoramic scout, the exposure area cannot be sent to the unit.</p>	<p>The panoramic image is horizontally flipped.</p>	<p>Revert the image by flipping it back to the original and respecify the exposure area.</p>

Exposures and Main Unit		
Problem	Possible Cause	Remedy
Panorama & Cephalo <ul style="list-style-type: none"> • Image too light • Line in image • Large white border • Partial image • Completely black 	<ul style="list-style-type: none"> * Noise Interference * Short, temporary power cut 	Turn unit off. Make sure of patient and user safety. Turn unit back on and see if it works normally. Make sure that the power supply is AC 108 to 132 V (Including line voltage regulation) with at least 20 A capacity for EX-1, AC 220/230/240 V, 16 A for EX-2 and that the unit is properly grounded. Do not use devices which might produce noise during an exposure.
<ul style="list-style-type: none"> • Unit spontaneously goes back to same condition as when it was turned on at first. • Or switches will not work at all 		Turn unit off. Make sure of patient and user safety. Turn unit back on and see if it works normally. Make sure that the power supply is AC 108 to 132 V (Including line voltage regulation) with at least 20 A capacity for EX-1, AC 220/230/240 V, 16 A for EX-2 and that the unit is properly grounded.
Panorama & Cephalo Image has strobe effect	Metal prosthetics can cause excessive feedback in the Auto Exposure system and produce a strobe effect. (AE Strobe)	Check by making exposure without using AE
Incisor area is blurred	Poor patient positioning	Review patient positioning procedures. Patient may have moved after auto positioning was completed. For manual positioning, coronal beam may not have been lined up with the upper left canine
Center of panorama image is white and left side is contracted.		
Inconsistent density	Application setting	Configure application with tool bar
Uneven image density	i-Dixel application setting	Adjust density with i-Dixel tool bar settings
Extremely dark areas or entire image is too white	Poor exposure condition settings	Adjust Auto Level or manual kV and mA settings

Exposures and Main Unit		
Problem	Possible Cause	Remedy
<ul style="list-style-type: none"> • LCD goes out. • Weird characters in LCD • Error message in LCD • LCD color is abnormal • Unit spontaneously goes back to same condition as when it was turned on at first. • Switches will not work at all 	Build up of static electricity	<p>Turn unit off. Make sure of patient and user safety. Turn unit back on and see if it works normally.</p> <p>Make sure ground is properly connected. Maintain room temperature.</p>
<p>Message in arm display</p> <p>LIFT OVERLOAD</p>	Patient is leaning or pulling on frame	Have patient relax and not lean or pull on the frame.

Message Numbers

Messages appear in the Arm Display when anomalies are detected. Respond according to the error message number as explained in the following chart. If this does not solve the problem, contact your local dealer or J. MORITA OFFICE. Make a note of the error number and report it when requesting help for the company.

Message No.	Possible Cause	Remedy
00	Overcurrent protection for the low-voltage circuit is activated.	Turn off, wait 1 minute, turn back on
01	Short pin is not installed on DCN12 of the CPU1board.	Contact your local dealer or J. MORITA OFFICE.
02	X-ray head overheat! Leave the unit at least 30 minutes to cool down.	Wait at least 30 minutes for the unit to cool down. Overheating is due to excessively frequent X-ray emission. This will eventually degrade the tube performance and should be avoided.
03	X Axis of the Arm did not return to its original position in specified time.	Press Ready key and put unit into Ready mode
04	Y Axis of the Arm did not return to its original position in specified time.	Press Ready key and put unit into Ready mode
05	Arm did not return to its original position in specified time.	Press Ready key and put unit into Ready mode
06	AF Beam did not return to its original position in specified time.	Press Ready key and put unit into Ready mode
07	Horizontal slit did not return to its original position in specified time.	Press Ready key and put unit into Ready mode
08	X-Ray Head did not return to its original angle in specified time.	Turn off, wait 1 minute, turn back on
09	Overcurrent protection for the high-voltage circuit is activated.	Turn off, wait 5 seconds, turn back on

Message No.	Possible Cause	Remedy
C1	No communication with the host computer.	Error C1 occurs when there is no response from the application software. Make sure that the computer and the HUB are turned on and that the application is running. Then turn the X-ray unit off and back on again.
C2	Transmission speed of the HUB doesn't match.	Check connections between HUB and main X-ray unit.
C3	No response from HUB.	Check connections between HUB and main X-ray unit.
C4	No response from PC.	Check connections between HUB and computer. Make sure computer is turned on.
C6	Application software is not running.	Make sure application software is running.
C7	The network interface card in the computer does not support jumbo frames.	Change the setting of the network interface card to support jumbo frames.
C0	No response from the application software.	Restart application software.
10	The Cephalo mechanism is not moving.	Do exposure over again
11	The positioning is not correct for the selected imaging mode.	Check exposure mode and patient direction, LA or PA
13	Imaging module is busy, capture is not possible.	Turn off, wait 5 seconds, turn back on
14	Error in communicating between imaging module and main control.	Turn off, wait 5 seconds, turn back on
15	AF function is not available in the Double-Ready* ¹ mode or during another operation. * ¹ The Double-Ready function is not enabled by default. To enable the Double-Ready function, contact your local dealer or J. MORITA OFFICE.	Adjust the AF only when the unit is in Ready condition and not moving.
16	No response from the patient positioning unit and cephalo-unit. Patient positioning is not available but image capture may be possible.	Turn the unit off, wait about one minute and then turn it back on.
18	Computer is not ready to capture images.	Make sure application is running. Check for error messages. Check LAN cable connections.

Message No.	Possible Cause	Remedy
19	Error in the patient positioning unit and cephalo-unit. Patient positioning operation is suspended for safety.	Guide the patient away from the unit. Turn the unit off, wait about one minute and then turn it back on.
22	No analog power given to the imaging module.	Contact your local dealer or J. MORITA OFFICE.
23	HORIZONTAL BEAM did not return to its original	Press Ready key again to put unit into Ready mode
26	Right & left beam did not return to its original position in specified time.	Press Ready key again to put unit into Ready mode
27	Cephalo slit did not return to its original position in specified time.	Press Ready key again to put unit into Ready mode
29	Cephalo imaging module did not return to its original position in specified time.	Press Ready key again to put unit into Ready mode
30	Cannot establish communication with the driver software. The application software may not be ready, or busy in processing data.	Start the application software if it is not already running. Wait for the computer to finish if it is busy reconstructing an image or some other processing procedure.
32	Vertical slit did not return to its original position in specified time.	Press Ready key again to put unit into Ready mode
33	Hardware backup timer has been activated.	Turn off, wait 1 minute, turn back on
35	The computer is not receiving the image. X-ray is terminated.	Make sure the application is running properly. Restart it if you are not sure. Check for computer errors. Check LAN cable connections. If the above does not solve the problem, restart the computer.
36	No response from the touch panel module.	Turn off, wait 1 minute, turn back on

Message No.	Possible Cause	Remedy
37	The touch panel is not connected with its controller.	Turn off, wait 1 minute, turn back on
39	High-voltage circuit is not working. X-ray is terminated.	Turn off, wait 1 minute, turn back on
42	Before pressing the READY key, have the patient exit the unit and close the Temple Stabilizer completely. Failure to do so may result in the arm striking the patient or Temple Stabilizer during rotation.”	When the exposure is over, guide the patient away from the unit and close the temple stabilizer completely before pressing the Ready key (or emission button).
43	Exceeded the operational range of the unit. Adjust the image layer beam (front back beam) backward to be in the operational range.	Move coronal beam back
44	Exceeded the operational range of the unit. Adjust the image layer beam (front back beam) forward to be in the operational range.	Move coronal beam forward
45	Unclear LAN error.	Turn off, wait 1 minute, turn back on. Restart the application software. Check if there are any computer errors. Make sure LAN cables are properly connected. If above actions do not solve the problem, restart the computer.
46	Unable to establish connection with the PC. System will not be able to receive images properly. Do not continue to use the unit in this state. Contact your J.MORITA Service Center/ Distributor to restore the setting.	Contact your local dealer or J. MORITA OFFICE.
54	Arm motor is not moving	Contact your local dealer of J. MORITA OFFICE to have the unit inspected and repaired.
56	Scout position was changed, to reactivate the Scout Positioning, select the position and click SetPos on the PC again.	<ul style="list-style-type: none"> • If you wish to use the new position, ignore this message and continue with X-ray emission. • You can reset the FOV using the software application. • Press the Ready key. The select the panorama scout or the two-direction scout to redo the positioning.

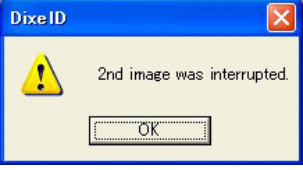
Message No.	Possible Cause (appears in LCD)	Remedy
57	<p>2nd image was cancelled.</p> <p>* The message below appears when this error occurs.</p> 	<p>Press the Ready key and repeat the two-direction scout procedure. Hold down the emission switch unit the second exposure for the two-direction scout is completed.</p>
58	<p>2nd image was interrupted.</p> <p>* The message below appears when this error occurs.</p> 	<p>Press the Ready key and repeat the two-direction scout procedure. Hold down the emission switch unit the second exposure for the two-direction scout is completed.</p>
99	<p>The error occurred between equipment and application software. Please reboot equipment and application software.</p>	<p>Turn off, wait 1 minute, turn back on</p>

<Cable Routing Diagram>

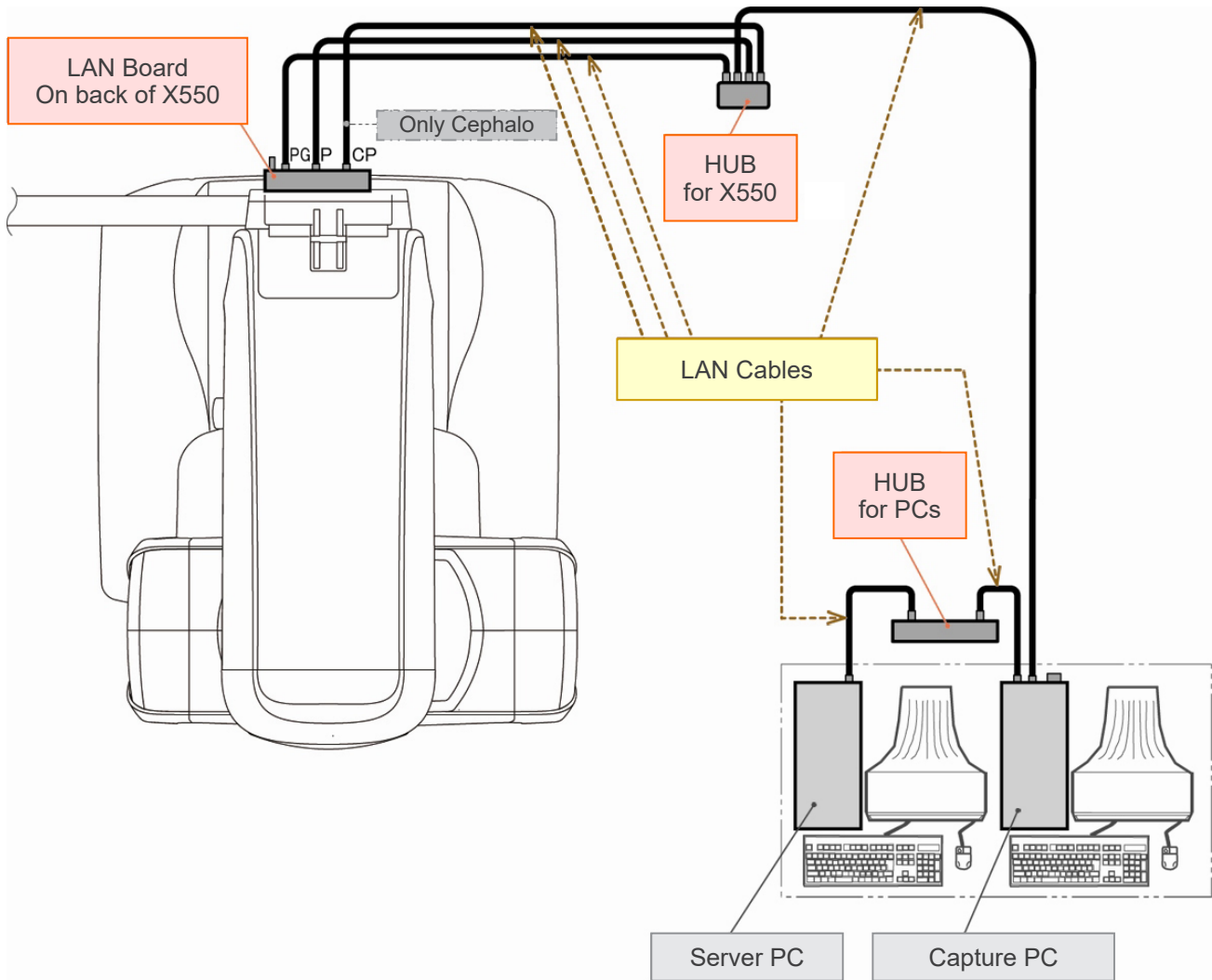

Cautionary Remarks on Imaging

Artifacts Due to Sensitivity Discrepancies of the Flat Panel Detector

The flat-panel detector (FPD) is an extremely dense and precise array of photo diodes (pixels). By compensating for the discrepancy in pixel sensitivity, the image can show greater detail than ordinary fluoroscopy. However, this discrepancy cannot be completely eliminated when a CT image is reconstructed.

To make a CT image, the X-ray beam rotates around the object and produces a fluoroscopic image. Points away from the center of the imaging area move on the imaging surface depending on the angle of their projection. This tends to even out the fluctuations in sensitivity, but it does not completely eliminate them. (See Fig. 1.)

Therefore, artifacts can appear near the center of the imaging area as shown in Fig. 2. The appearance of these artifacts depends somewhat on the exposure conditions and the X-ray transparency of the object.

To make a detailed analysis and precise diagnosis, the radiologist must carefully take into consideration the possibility and nature of artifacts.

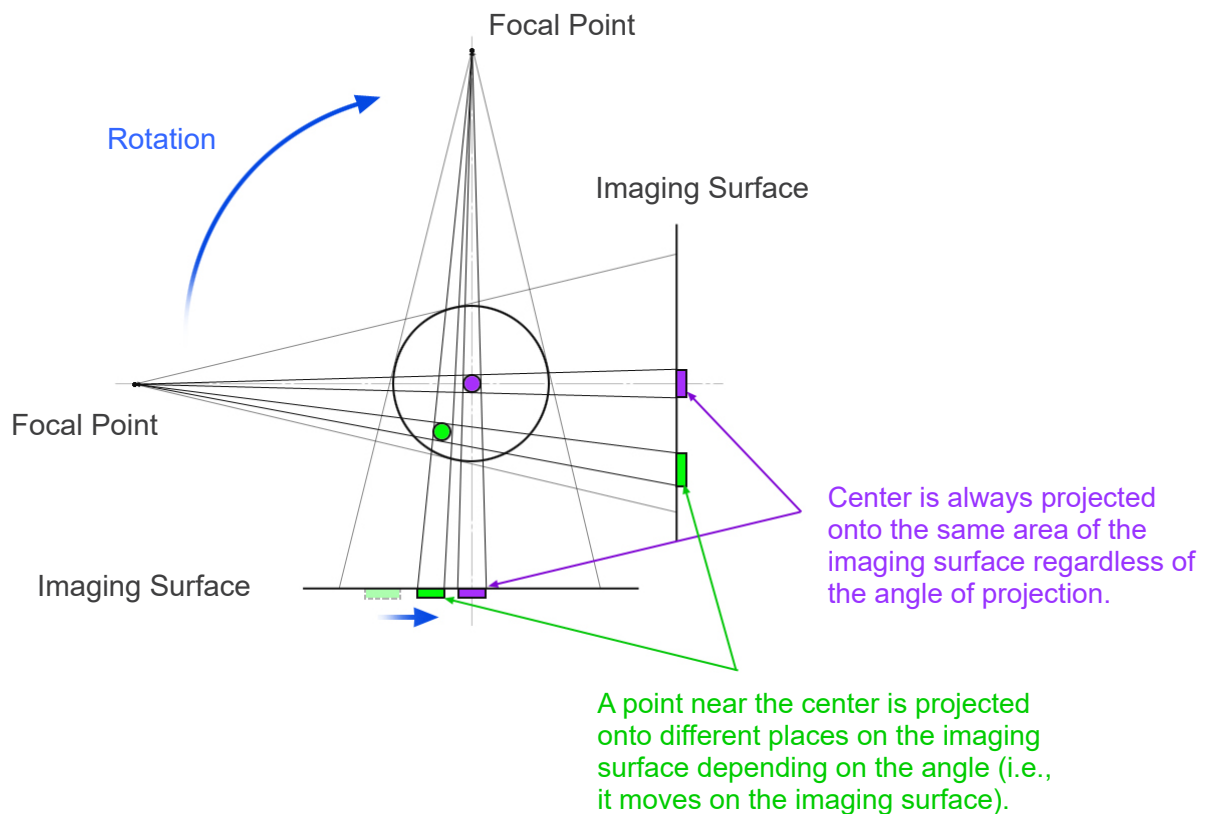

Note: View from above the plane of rotation

Fig. 1 Principle of CT Exposure

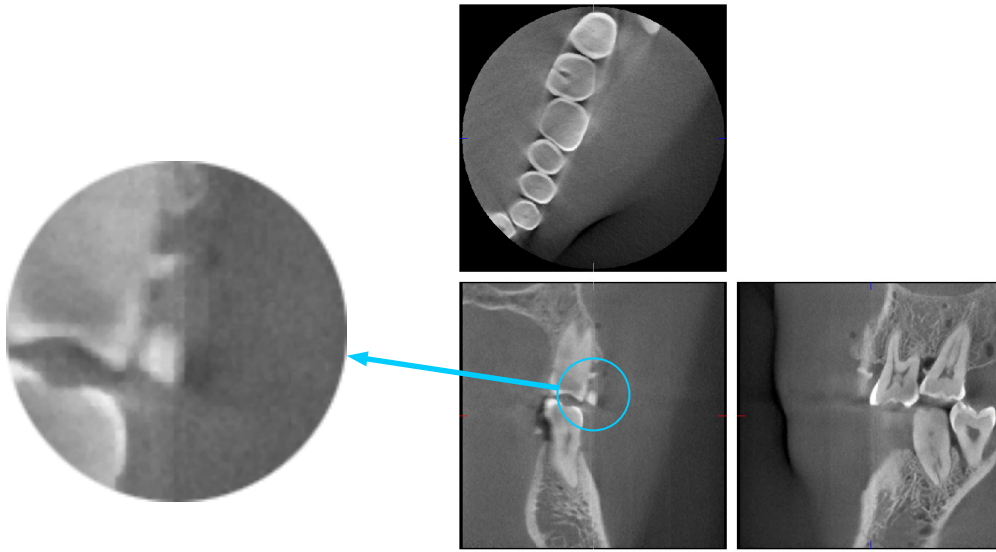

Fig. 2 Example of an Artifact

Artifacts Caused by Flat Panel Detector (FPD) Sensitivity Discrepancies

The Flat Panel Detector (FPD) consists of an extremely dense array of highly sensitive photo-diodes (pixels). Even though the panel is assembled in a clean room, even minutes deposits of dust or other debris can result in uneven discrepancies in the sensitivity of the photo-diodes. The image processing software compensates for these discrepancies and makes them all but invisible. However, logarithmic and filter processing during the reconstruction of the CT image may accentuate sensitivity discrepancies and produce artifacts in the CT image. These discrepancies will have an arc shape in axial (z-plane) images and appear as vertical lines in coronal and sagittal images (x- and y-planes). Photo 3 below shows examples of these artifacts. Artifacts can be identified by comparing the images of all 3 planes. If a vertical line in the coronal and sagittal planes is matched by an arc-shaped line in the axial plane, you may assume that these are artifacts.

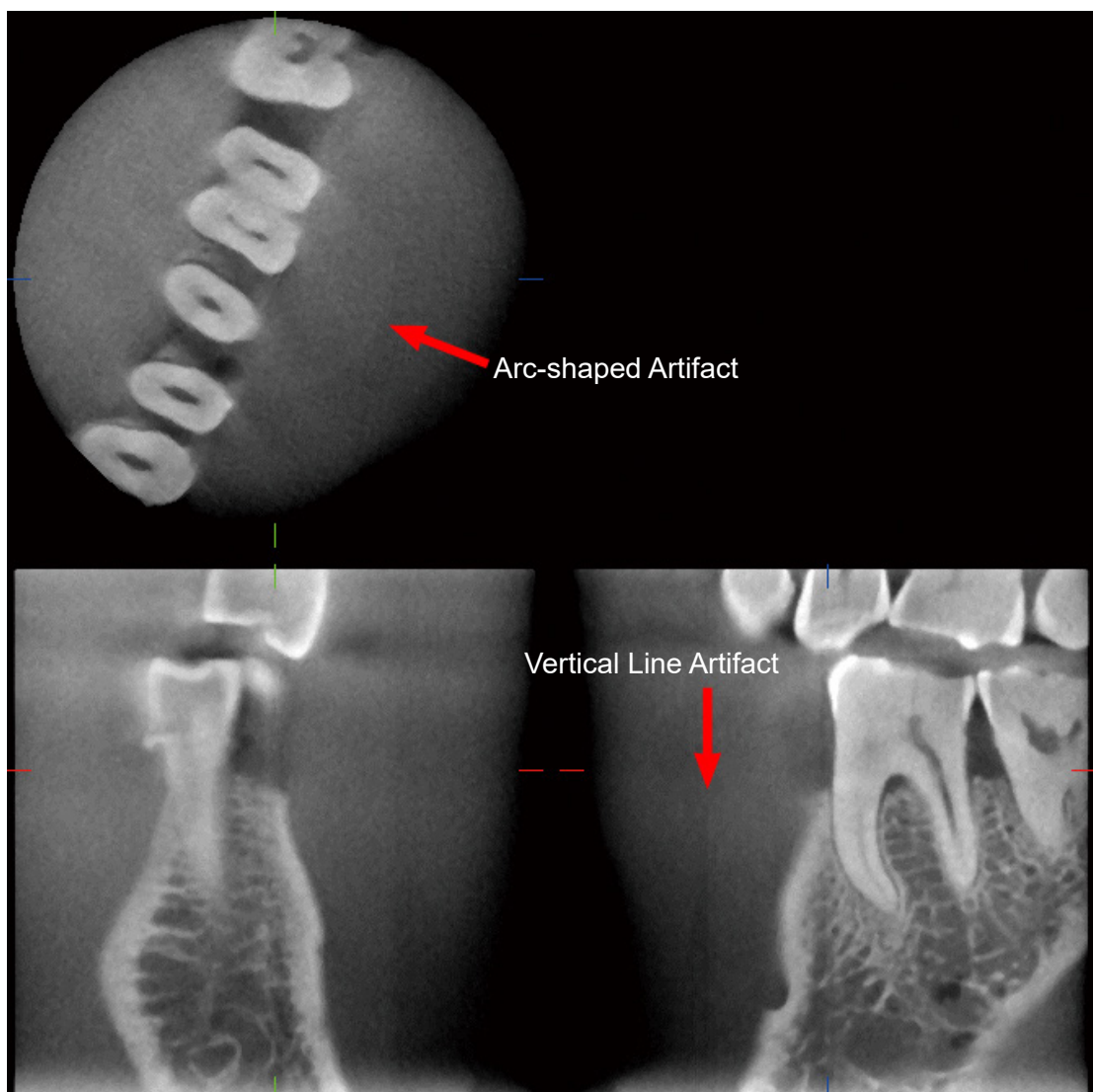

Photo 3 Example of an Artifact

Artifacts Due to the Angle of X-ray Penetration

Artifacts Characteristic of Cone Beam CT Imaging

Artifacts depend on how far the object is from the plane of the X-ray beam's rotation.

CT images are a kind of tomography; images are reconstructed after collecting the images produced by the passage of X-rays emitted by a rotating beam. (Fig. 4.1)

For cone beam CT imaging, artifacts appear above or below the plane of the beam's rotation because of insufficient information. These artifacts appear on a straight line running from the object to the source of the X-ray beam, and they are more conspicuous the farther the object is from the plane of the beam's rotation.

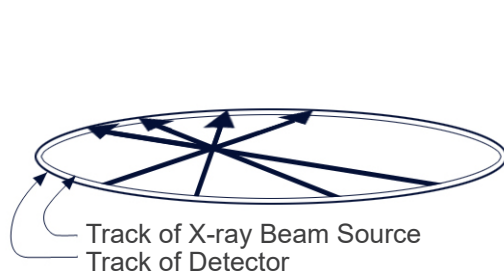

Fig. 4.1

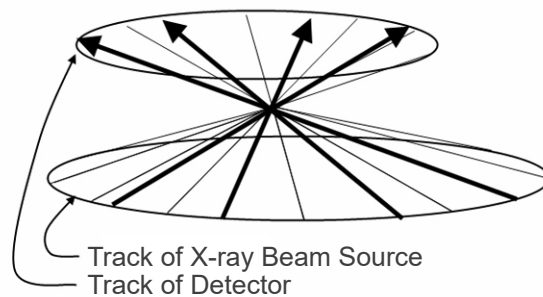

Fig. 4.2

Figure 4.1 shows the tracks of the source of the X-ray beam and the detector during X-ray emission, and the arrows show the direction of the X-rays.

Since both the source of the beam and the detector travel in the same plane, the tomographic image of that plane can be completely reconstructed.

Figure 4.2 shows that some data for some areas away from the plane of the beam's rotation is also collected, but since these areas are not evenly irradiated by the beam from every direction, this results in the appearance of artifacts in the tomographic image.

Photos 5 compares the case of 2 images of the same tooth made at different vertical positions.

An artifact appears at the tip of the tooth because this area has a high CT value. In Photo 5.1, the artifact is nearly horizontal because it is at about the same height as the source of the X-ray beam. In Photo 5.2 the artifact is slanted because it is farther away from the plane of rotation for the beam source. It is also wider.

Radiologist must carefully take into consideration the nature of artifacts at the periphery of the area of interest.

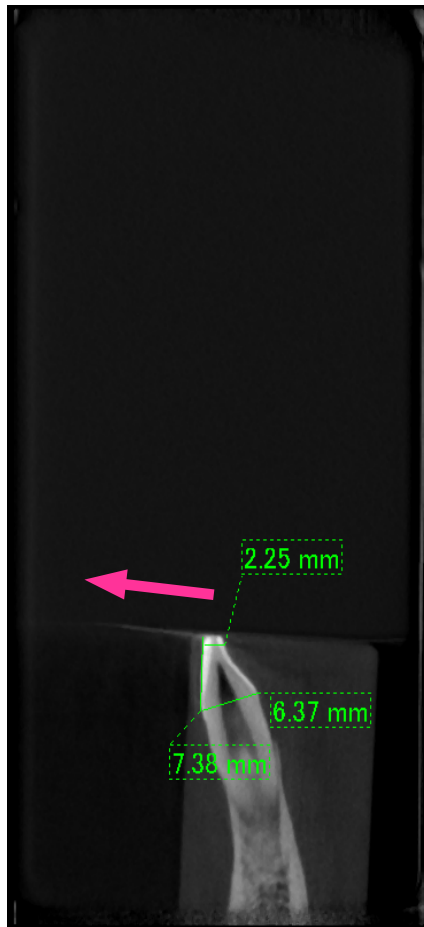

Photo 5.1



Photo 5.2

In photo 5.1, the artifact is produced near the plane of the beam's rotation. In photo 5.2, the area of the artifact is farther away, making it more conspicuous and giving it a different direction.

Accurate Measurement of Thickness

Following the principle stated above, the farther the area is from the plane of the beam's rotation, the less accurate the image is. This is demonstrated by measuring the thickness of a flat object positioned horizontally.

Photo 6 shows the images of aluminum disks with a thickness of 1.0 mm positioned 20 mm apart and parallel to the plane of the beam's rotation. The bottom disk is 10 mm up from the bottom edge of the image, and this is the same as the plane of the beam's rotation. Therefore its thickness can be measured accurately. However, the measurement for the middle disk, which is 20 mm higher, is less accurate, and the measurement for the top disk is the least accurate of all. The farther a disk is from the plane of the beam's rotation, the thicker it appears.

This is because of an overlapping artifact which stretches up at an angle and blurs the edge of the disk.

This phenomenon must always be kept in mind for accurate diagnosis and analysis. Whenever an accurate measurement of thickness is required, adjust the bite block to position the area at the same height as the source of the X-ray beam.

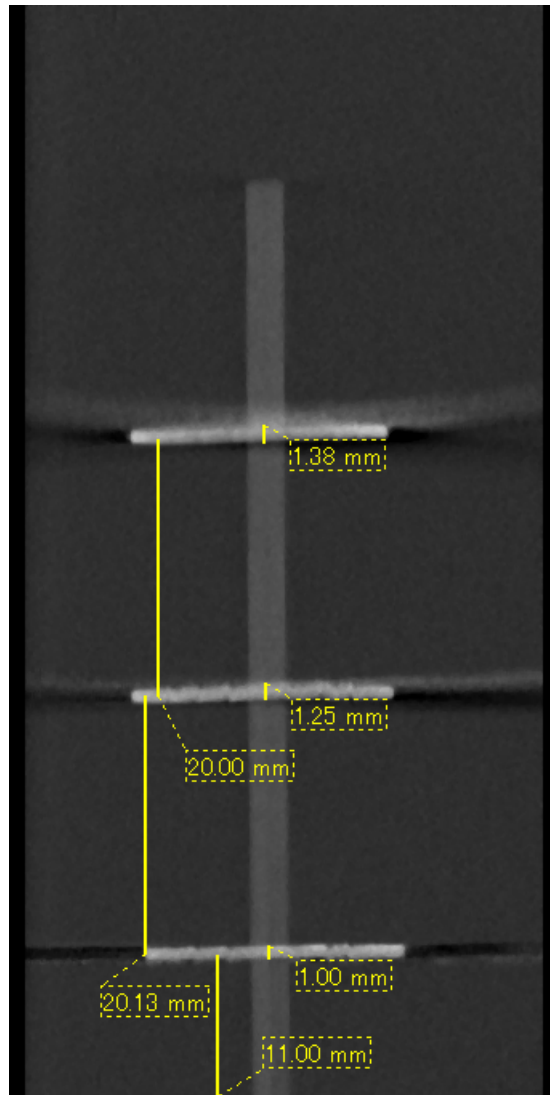

Photo 6 CT image of three aluminum disks, each 1.0 mm thick, parallel to the plane of beam rotation but at different heights.

The lowest one can be accurately measured because it is at the same height as the plane of the beam's rotation. The farther the disks are from the plane of the beam rotation, the thicker they appear in the image.

Artifacts due to Metal Prosthetics

Useful images may not be possible if a patient has metal fillings or prosthetic devices, and it is usually impossible to make a useful image of a crown if it is right next to a metal prosthetic.

Also it is sometimes impossible to make useful images of a root or jaw bone if there is a metal post, crown or other prosthetic right next to it.

Photos 7 through 13 were made of a mandible model with various metal prosthetics, posts and canal fillings to demonstrate what needs to be taken in consideration for accurate diagnosis and analysis.

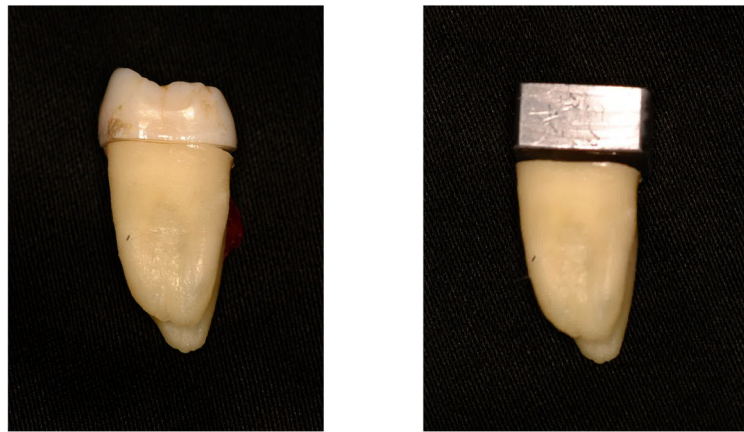
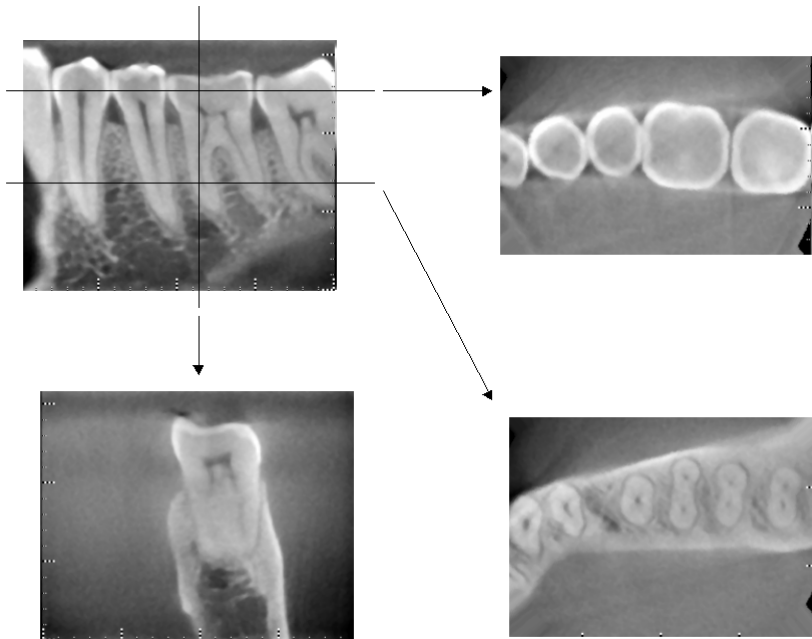
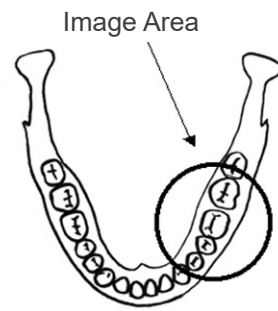
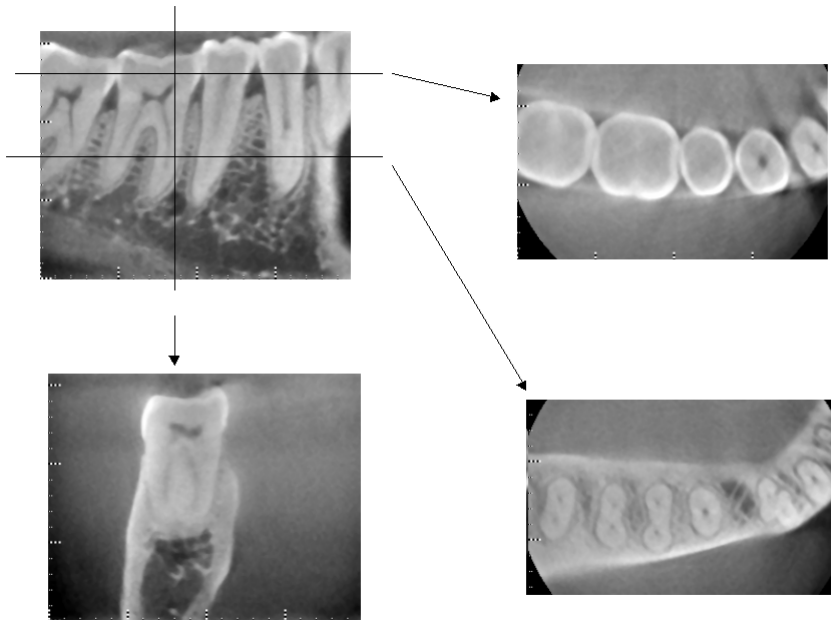
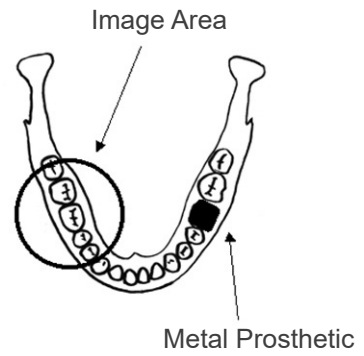

Photo 7 Model of full metal crown.
(Top of crown was removed and replaced with a piece of lead.)



Photos 8 No metal Prosthetic
(Top: Model and Image Area. Bottom: Images.)



Photos 9 Full metal crown is on the opposite side of the image area.
(Top: Model and Image Area. Bottom: Images.)

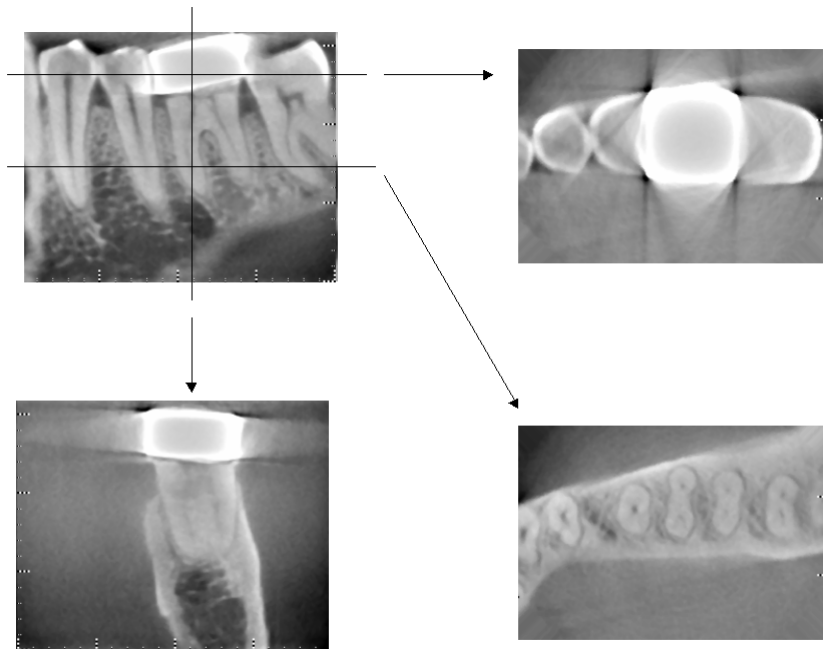
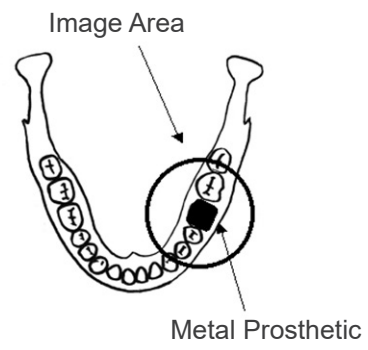

Photos 10 Imaging area on same side as metal crown
(Top: Model and Image Area. Bottom: Images.)



Photos 11 Post and Crown
(Left: Post and Crown made after filling root canal with gutta-percha and point. Center: Post and Crown attached to tooth. Right: Simple dental X-ray.)

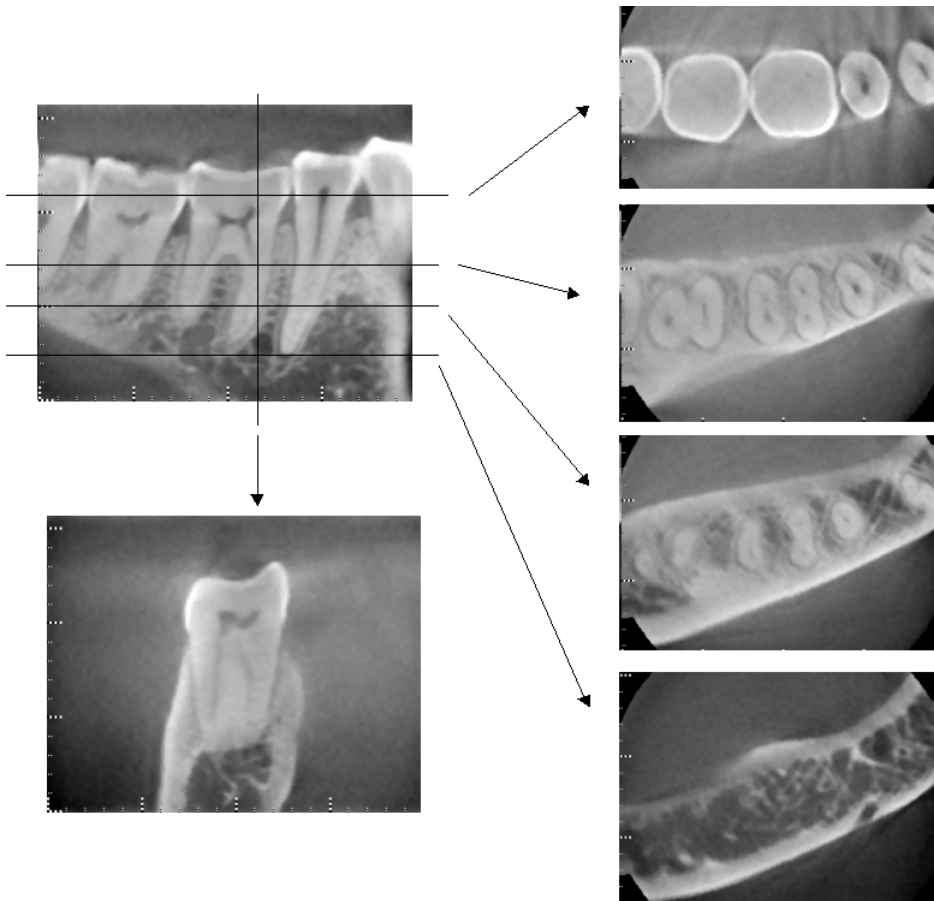
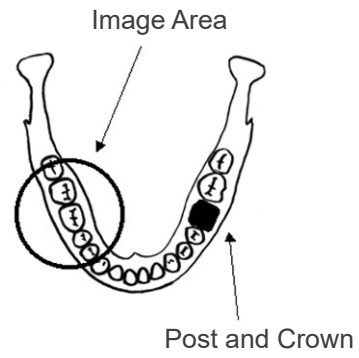

Photos 12 Image area on opposite side.
(Top: Model and Image Area. Bottom: Images.)

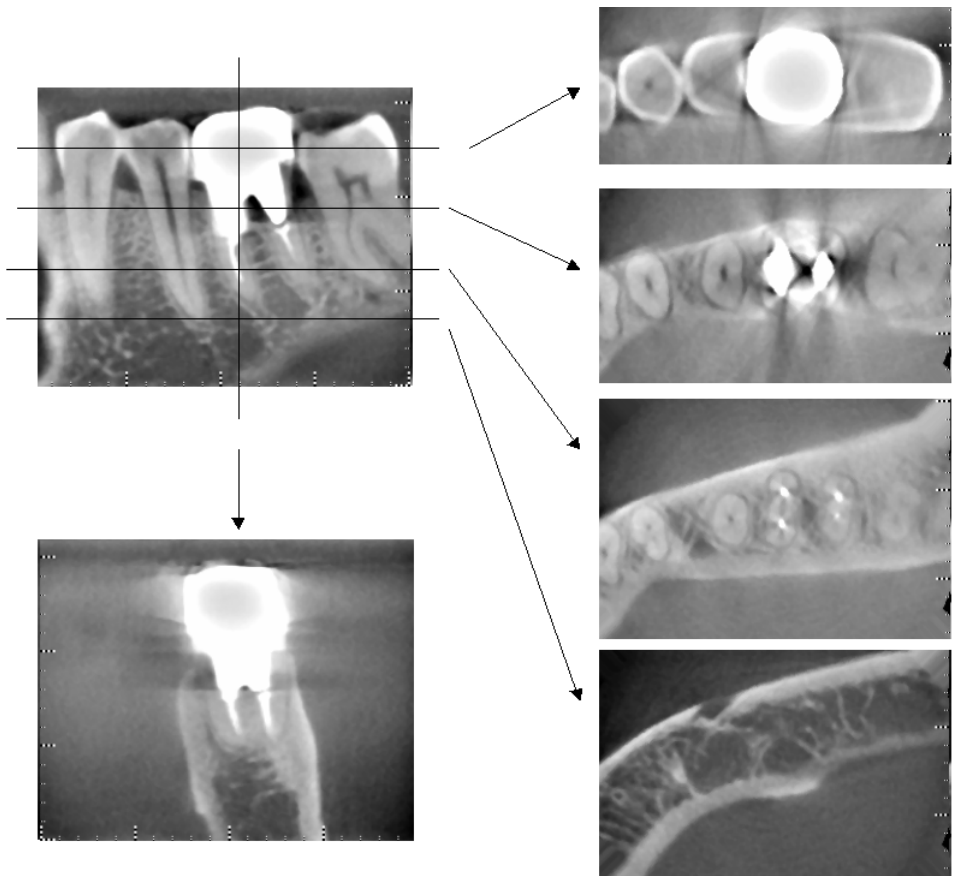
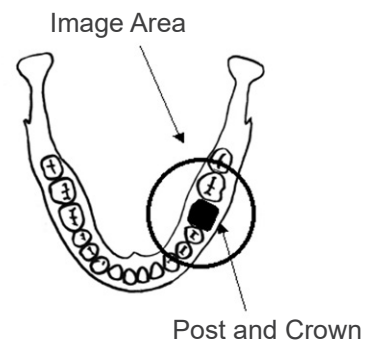

Photos 13 Image area on same side
(Top: Model and Image Area. Bottom: Images.)

Artifacts for 180° Exposures

For 180° exposures, when the X-ray beam passes through the lower plane (a) in Figure 14, the result is the flat shape shown in Figure 15, where the beginning of 180° circuit matches the end of the circuit.

However, when the X-ray beam passes through the upper plane (b) in Figure 14, the result is the conical shape shown in Figure 16, where there is a discontinuity between the beginning and end of the circuit.

Therefore, some slight streaking appears in a 180° exposure that does not appear in a 360° exposure (Figure 17). These streaks run in the direction of the rotation. As a result, some semi-circular artifacts appear in the Z-plane image, and these must be recognized and taken into consideration for accurate diagnosis and analysis.

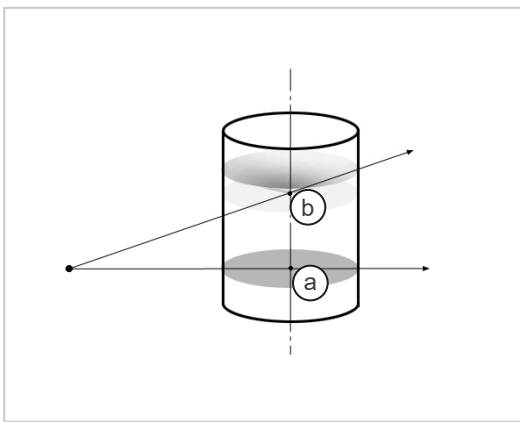

Fig. 14

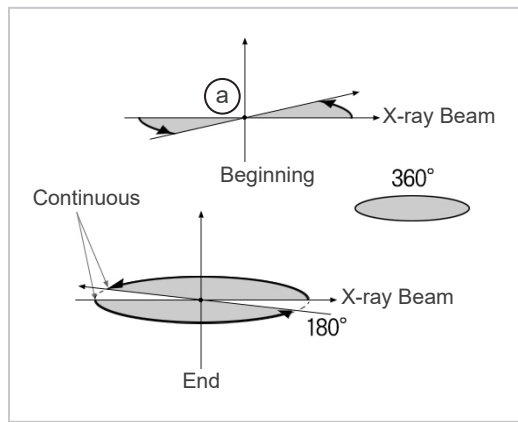

Fig. 15

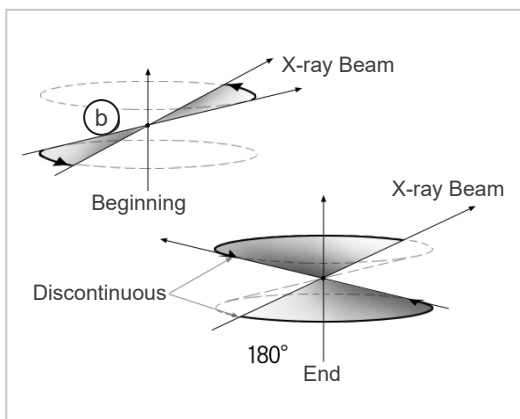

Fig. 16

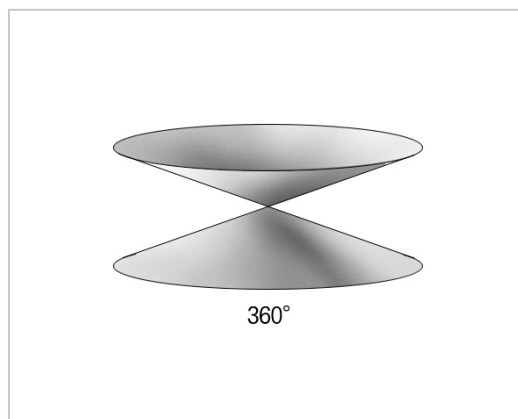

Fig. 17

DDAE Verification Procedure

1. DDAE Verification

DDAE (Digital Direct Auto Exposure) is verified by this procedure.

1) DDAE Verification Flowchart

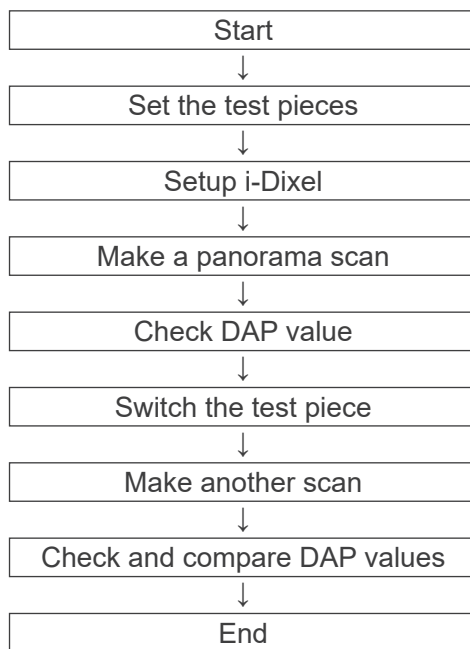

2) Warning and Caution

If any errors occur during the verification procedure, turn off Veraviewepocs immediately. After checking the conditions, restart the procedure from "Start".

2. Setup

1) Test Piece (option)

DDAE verification uses copper plates attached to Veraviewepocs. Test copper piece consists of three copper plates (1), (2), (3)

2) Set the Test Pieces

2)-1 Remove the chin rest and close the temple stabilizers.

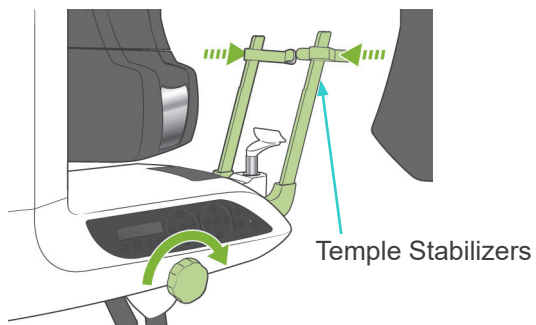

2)-2 Set the Test Piece as shown below.

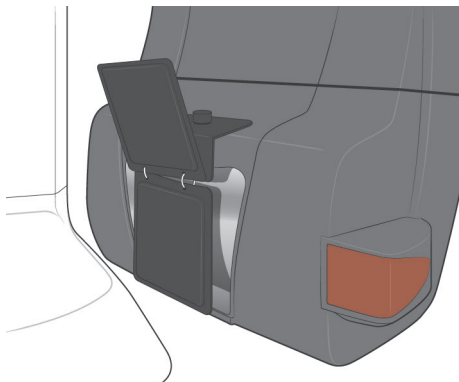

3) Setup i-Dixel

3)-1 Startup i-Dixel

3)-2 To add “Additional Information” in the Tool Panel if it is not shown, go to “Home Menu” and open “Settings Window” by clicking the screw wrench button at the bottom.

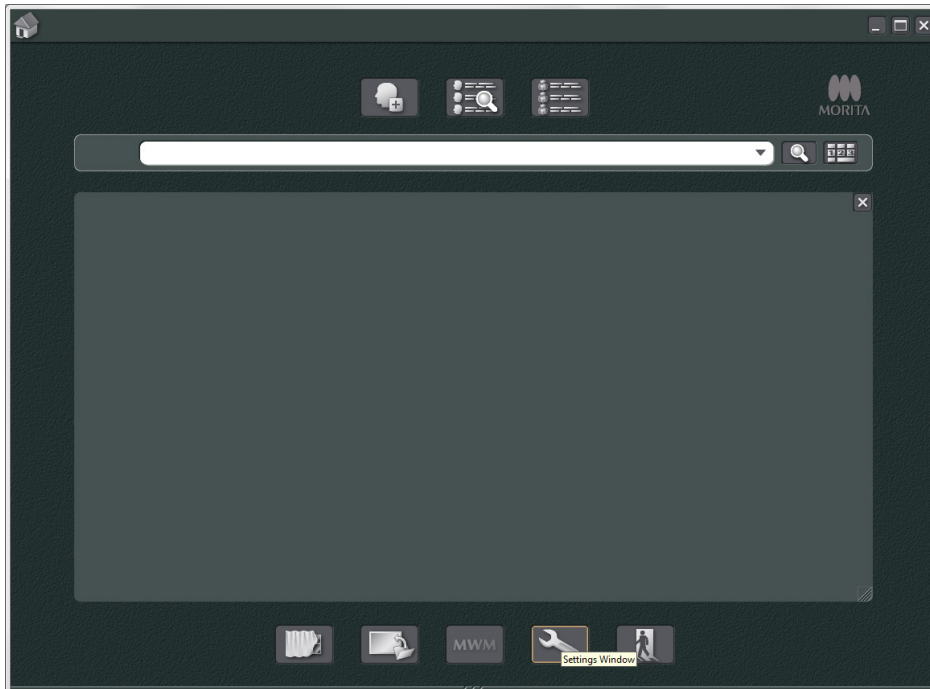

3)-3 Open Tool Panel tab and select “Additional information” Available buttons box on the left. Then, click “Add>>”.

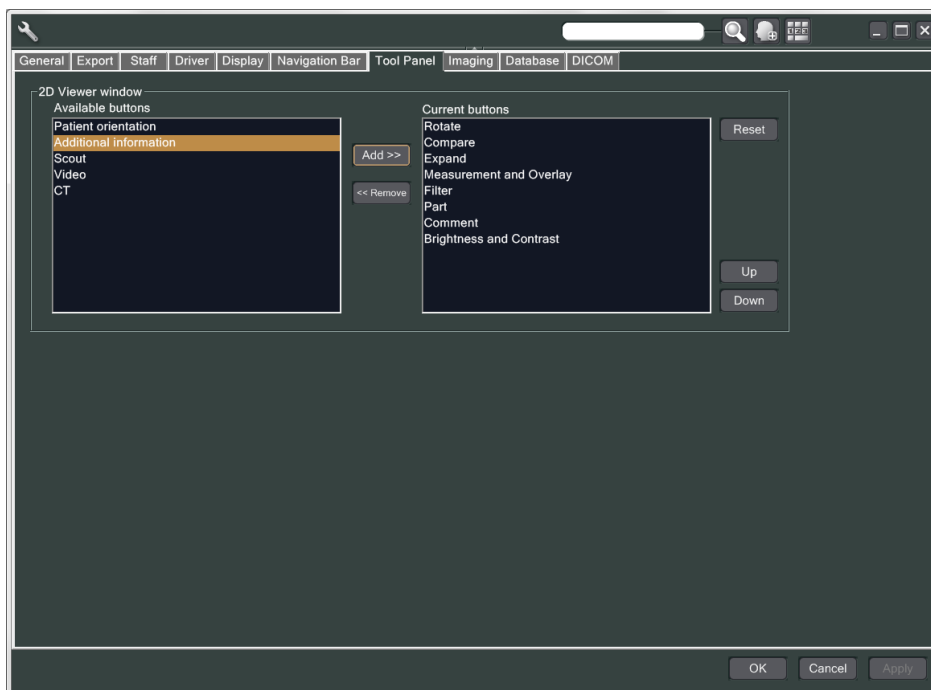

3)-4 Click OK, and restart i-Dixel so that the change is reflected.

3. Make exposure

1) Startup

- 1)-1 Open a patient for the test.
- 1)-2 Turn on the Veraviewepocs.

2) Make a panorama exposure

- 2)-1 Set the copper plate (1) + (2). Two plates are to be in the X-ray field.
- 2)-2 Make a Panorama exposure with Auto Exposure Level "0".
- 2)-3 Check DAP Value
After the exposure, check the Additional information. Additional information is shown at the bottom in the right pane. Scroll down the window to find the DAP value.

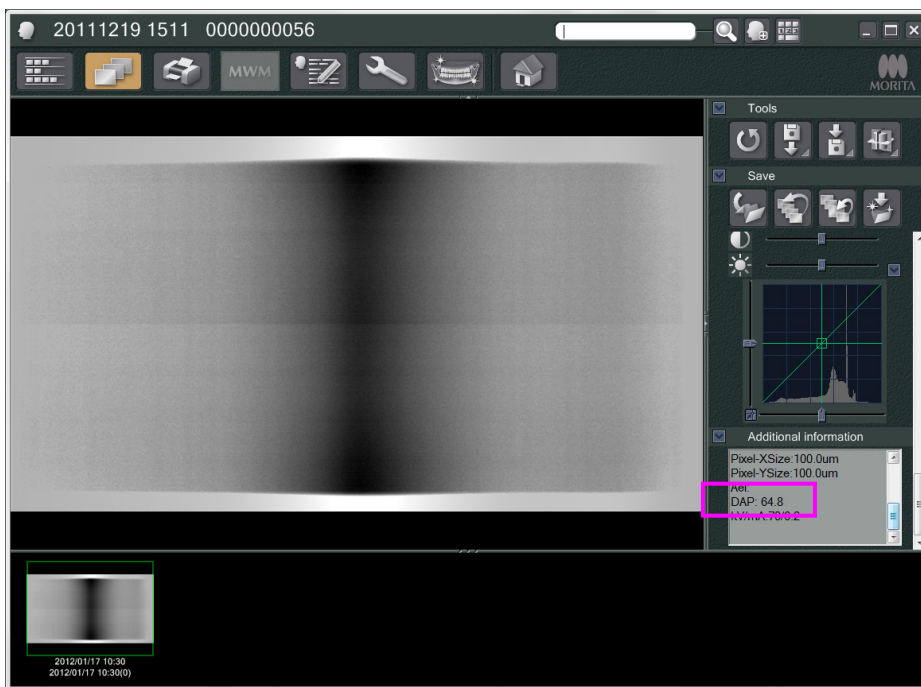

- 2)-4 Memorize the DAP value.

3) Make another scan

- 3)-1 Remove copper plate (2). Use only 1 plate in the X-ray field.
- 3)-2 Make a Panorama scan with Auto Exposure Level "0".
- 3)-3 Check the DAP value in the same way.

4. Verification Procedure

- 1) Compare the DAP values from the previous two scans; scan with the copper plate (1) and with the copper plate (1) + (2).
- 2) Check if the value with the copper plate (1) + (2) is greater than the one with the copper plate (1).
- 3) Use the following flowchart to verify the DDAE.

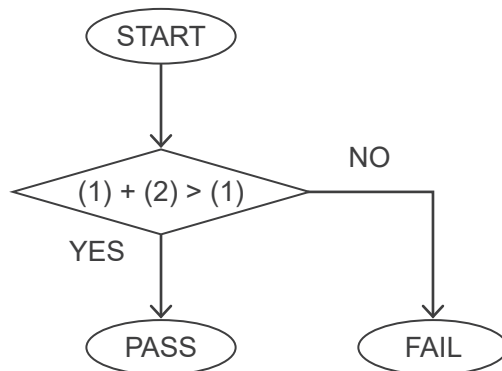

4) Results

PASS : DDAE operates correctly.

FAIL : Try the same procedure carefully again.

If still not improved, please contact your local sales representative.

Technical Specifications

1. Specifications

Product Name	Veraviewepocs
Model	X550
Type	EX-1 / EX-2

Classification

Protection against electric shock	Class I, Type B
Type B applied parts	Temple Stabilizers, Ear-rods, Chin Rest, Bite Block, Bite Plate, Nasion Plate, Hand X-ray Plate, Lip-nose Rest, and Patient Handles (non-conductive connection to patient)
Protection against ingress of liquids	IPX0
Operating altitude	3000 m (max)
Pollution degree	2
Overvoltage category	II
Disinfection methods:	
- Every patient, disinfect the Type B applied parts by wiping them with Ethanol (70 vol% to 80 vol%). If it is not possible to obtain Ethanol (70 vol% to 80 vol%), use one of the disinfectants listed below; do not use any other type of disinfectant.	
• DÜRR DENTAL's FD 322 quick disinfectant	
• DÜRR DENTAL's FD 333 quick disinfectant	
• DÜRR DENTAL's FD 360 imitation leather cleaning and care	
• DÜRR DENTAL's FD 366 sensitive Rapid disinfection	
- Once a day, wipe the operation panel with Ethanol (70 vol% to 80 vol%) and wipe the LCD with a dry cloth.	
- Single use item; mouth piece and bite block cover.	
Mode of operation	Non-continuous operation

Product Description

Dental Panoramic X-ray unit with a high frequency switching mode X-ray generator. In addition to panoramic exposure, the unit can also take scanograms. Also cephalometric device is available that uses the panoramic X-ray source.

Further more a three dimensional Cone Beam Computed Tomography (CBCT) is also available, which uses cone shaped X-ray beam projected on to a flat panel detector.

Intended Use

X550 is used for diagnostics in dentistry by exposing X-ray image receptor and for the use by authorized persons in the practice of dentistry or medicine, and/or associated procedures.

X550 is intended for dental radiographic examination and diagnosis over the whole Dent-maxillofacial area such as teeth, periodontal tissues or chin-bone etc.

X-ray Tube Head Assembly with High Voltage Generator

Tube	D-051
Focal Spot	0.5
Target Angle	5°
Target Material	Tungsten
Filtration	Inherent filtration: minimum 2.5 mm Al, 75 kV/HVL 3.5 mm AL (X-ray tube filtration: 0.8 mm Al + Al filter: 1.7 mm) Additional filtration: 0.2mm Cu for CT (9.6 mmAl, 75 kV/HVL 3.5 mmAL)
Beam Quality	HVL minimum 3.2 mm Al at 90 kV
Maximum Output Power	0.9 kW nominal at 90 kV, 10 mA 0.72 kW nominal at 90 kV, 8 mA for CT
Rectification	Direct Current
Filament	Preheated
Duty Cycle	1:59, 90 kV / 10 mA for example, maximum 20.3 s of irradiation with 1198 s (20 min) of interval
Outer Shell Temperature	45°C maximum
Cooling	Oil Cooling
Maximum Heat Unit of X-ray Tube Head Assembly	194.45 kJ (1 HU=1.35 Joule)
Maximum Heat Dissipation of X-ray Tube Head Assembly	2 kJ/min.
Primary Protective Shielding	Minimum 1.5 mm Pb or equivalent
Leakage Radiation	Max. 1.0 mGy/h at 1 m
Weight of X-ray Head	13.8 kg (with collimators)

Control

Operating Tube Potential	Panoramic: 60 to 80 kV (± 1 kV, 21 steps) Digital Display Cephalometric: 60 to 90 kV (± 1 kV, 31 steps) Digital Display CT: 75 to 90 kV (± 5 kV, 4 steps) Digital Display Accuracy of displayed values: $\pm 10\%$
Operating Tube Current (1 mA or R20 step)	1 to 10 mA 1 to 8 mA (CT at 85, 90 kV) Accuracy of displayed values: $\pm 10\%$

Exposure Time

CT: 9.4 s / Two-direction Scout: 1 s (0.5 s × 2)

Dental arch panoramic:

Patient Size	Magnification	Tomographic Orbit	High Speed Mode	High Definition Mode
Adult	1.3	Standard	7.4 s	14.9 s
		Shadowless	7.9 s	15.8 s
		Orthoradial	8.1 s	16.2 s
	1.6	Standard	8.1 s	16.2 s
		Shadowless	8.3 s	16.5 s
		Orthoradial	8.1 s	16.2 s
Pedodontic	1.3	Standard	6.5 s	13.0 s
		Shadowless	6.5 s	13.0 s
		Orthoradial	6.5 s	13.0 s
	1.6	Standard	6.0 s	12.0 s
		Shadowless	6.0 s	12.0 s
		Orthoradial	6.0 s	12.0 s

* For 40P and 40CP models, only High Speed is available.
 Partial Panorama is a part of Dental arch panorama.
 Exposure Time: Refer to LCD display

Maxillary Sinus Panoramic:

Patient Size	High Speed Mode	High Definition Mode
-	10.1 s	20.3 s

* For 40P and 40CP models, only High Speed is available.

TMJ Quadruple (2/4 images):

Patient Size	High Speed Mode	High Definition Mode
Adult / Pedodontic	4.3 s	8.6 s

* For 40P and 40CP models, only High Speed is available.

Cephalometric:

Direction	Lateral		PA
	Full	Partial	
Density Comp. ON	5.8 s	4.2 s	4.1 s
Density Comp. OFF	3.5 s	2.6 s	5.0 s

Accuracy of displayed values: ± (5% + 50 ms)
 (* Registered value for FDA is ±10%)

Test instruction of X-ray tube voltage, current, and exposure time
 Reproducibility of air kerma
 Minimum mAs

Constant (manual) exposure mode
 Coefficient of variation max. 0.05
 Dental Arch Panoramic: 6.0 mAs
 Cephalometric: 3.5 mAs
 CT: 9.4 mAs
 Dead Man Type

Emission Button

Auto Exposure (Not applied for Cephalometric and CT scan)

Setting parameters +4 to -4 (9 steps) Digital Display
 Maximum possible excursion 60 to 80 kV
 1 to 10 mA
 Minimum exposure time 4.3 s (Exposure time is fixed value, not auto exposure factor.)
 Reproducibility of air kerma Coefficient of variation max. 0.05
 Verification method by test piece

Power Requirements

	EX-1	EX-2
Input Voltage	AC120 V 60 Hz single phase	AC 220/230/240 V 50 - 60 Hz single phase
Line Voltage regulation*1	Max. 8%	Max. 8%
Range of line voltage	108 to 132 V (Including Line voltage regulation)	AC 220/230/240 V \pm 10% (Including Line voltage regulation)
Line current (Operation) <i>Panoramic, CT:</i> <i>With Cephalometric:</i> (Stand by)	Max. 19 A Max. 21.3 A Max. 1.2 A	10.4/ 10/ 9.5 A 10.4/ 10/ 9.5 A 1.0 A
Technique factor for the Maximum line current <i>Panoramic, CT:</i> <i>With Cephalometric:</i>	80 kV, 10 mA 90 kV, 10 mA	80 kV, 10 mA 90 kV, 10 mA
Power Consumption <i>Panoramic,CT:</i> <i>With Cephalometric:</i> <i>Stand by</i>	Max. 2.0 kVA Max. 2.3 kVA 0.3 kVA	2.3 kVA 2.3 kVA 0.3 kVA
Fuse at the distribution panel	20 A, 120 V, slow * The maximum current rating of this X-ray unit is momentary. The recommended ampacity of supply circuit conductor and the current rating of over current protection device are based on the National Electric Code 2017, Article 517, Part V, X-ray Installation	16 A, 220/230/240 V, slow
Power line resistance	Max. 0.5 Ohm	Max. 1 Ohm

Means isolation from supply mains EX-1 Mains plug, EX-2: Main switch

Circuit breaker shall be applied on distribution panel. It is recommended to wire a breaker only for this unit.

*1 Line-voltage regulation = $100 (V_n - V_i) / V_i$

V_n = No-load line voltage, V_i = Load line voltage

Mechanical parameters

Panoramic and CT	SID 518.5 mm (\pm 20 mm)
Cephalometric	SID 1,650 mm (\pm 20 mm)
Magnification	Standard Panoramic: 1.3 \times , 1.6 \times Maxillary Sinus Panoramic: 1.5 \times Pedodontic Panoramic: 1.3 \times , 1.6 \times Shadow Reduction Panoramic: 1.3 \times , 1.6 \times Orthoradial Panoramic: 1.3 \times , 1.6 \times Scanograms: 1.3 \times Cephalometric: 1.1 \times
X-ray Field	Panoramic: W6 \times H143 mm (W: +1mm or less on each side, H: inside image reception area) Cephalometric: W6 \times H220 mm (W: +1mm or less on each side, H: inside image reception area)
Weight	CT: User Information document Panoramic: Approx. 190 kg Cephalometric: Approx. 260 kg

Outer Dimensions		
Main Unit	W 1,020 × D 1,330 × H 2,355 mm (H 2,185 mm Option)	
	W 2,000 × D 1,330 × H 2,355 mm (H 2,185 mm Option) (with Cephalometric)	
Control box	W 70 × D 40 × H 115 mm	
Vertical Height of Focal Spot	1,055 to 1,775 mm (Panoramic)	
	970 to 1,605 mm (Option)	
	1,125 to 1,775 mm (with Cephalometric)	
	1,040 to 1,605 mm (Option)	
Patient Positioning	Auto focus using light sensor for distance measurement and electrically operated positioning system	
Patient Positioning Beam	Class 2 Laser. Accordance with 21CFR Part 1040.10 and IEC60825-1.	
	Beam divergence: 120 mm ±10% in length, 0.8 ±0.2 mm in width @250 mm	
	Pulse duration and repetition rate: Continuous	
	Maximum energy output: 1 mW	
Attenuation equivalent of Patient head stabilizer		
	Panoramic	less than 1.7 mmAl
	Cephalometric	less than 1.7 mmAl

Leakage Technique factors

80 kV, 600 mAs/h

(80 kV, 10 mA, duty cycle 1:59, for example 7.4 s exposure per 7 min 17 s cool-down period)

90 kV, 600 mAs/h

(90 kV, 10 mA, duty cycle 1:59, for example 4.9 s exposure per 4 min 49 s cool-down period)

Measurement Bases

Tube voltage: Actual X-ray radiation is monitored by Non Invasive Evaluator of Radiation Output.

Tube current: The mA is measured by monitoring current in the HT return line, which equals the tube current.

Exposure time: Exposure time is measured the open time of gate circuit which distributes high voltage to X-ray tube head assembly, by counter (TP8 – TP GND on CPU1 PWB)

Collimator

Panoramic slit, Cephalo slit (Cephalometric only), CT-A slit, V slit, CT-C slit (R100 only).

Image Quality

Panoramic:

Line pair resolution 2.5 LP/mm

Low contrast resolution diameter 2.0 mm

Cephalometric:

Line pair resolution 2.5 LP/mm

Low contrast resolution diameter 2.5 mm

CT:

Resolution (MTF) more than 2 LP/mm

Other index User Information document

X-ray Dose Information

The following image information is recorded for each exposure.

- Dose Area Product (DAP) (mGy × cm²)
- tube voltage average (kV)
- tube current average (mA)

Refer to the application's software manual as the displayed image information differs according to the application software.

The Dose Area Product (DAP) (mGy × cm²) may not be displayed depending on the application software.

The displayed Dose Area Product refers to the tube voltage (kV)/current (mA) for each exposure. The Dose Area Product is calculated based on typical measurement results.

The Dose Area Product displayed is the multiplication product of the air kerma and the size of the radiation field. These values are typical values and are not the measured Dose Area Products for each X-ray exposure.

The air kerma is calculated by divided the Dose Area Product by the X-ray field size.

The accuracy of the air kerma and the Dose Area Product do not exceed +/- 50%.

The dose meter to check and maintain the accuracy of the Dose Area Product indications shall be calibrated at the appropriate energy.

Method used to estimate dose area product: Measured by DAP (Dose Area Product) meter. The DAP meter is calibrated according to the instructions in the accompanying user manual. The DAP meter is attached to the front of the X-ray head for the Pan and CBCT, and in back of the secondary slit for the Cephalo. Be careful it does not fall and that its wiring is properly routed.

SIP/SOP Statement

LAN Interface: Unshielded twisted pair cable with RJ-45 plug connections, Length less than 3 m.

Requirements for Computers or Other Devices Connected to the Computers

1. The Veraviewepocs has been tested and found to comply with the limits for medical devices to the IEC 60601-1-2:2014 for electromagnetic disturbances. These limits are designed to provide reasonable protection against harmful interference in a typical medical installation. This equipment generates uses and can radiate radio frequency energy and, if not installed and used in accordance with the instructions, may cause harmful interference to other devices in the vicinity. However, there is no guarantee that interference will not occur in a particular installation. If this equipment does cause harmful interference to other devices, which can be determined by turning the equipment off and on, the user is encouraged to try to correct the interference by one or more of the following measures:
 - Reorient or relocate the receiving device.
 - Increase the separation between the equipment.
 - Connect the equipment into an outlet on a circuit different from that to which the other device(s) are connected.
 - Consult the nearest J. MORITA OFFICE, its representative or its dealer for help.
 2. The following equipment connected to the analog and digital interfaces must be certified according to the respective IEC standards (i.e. IEC 60950-1 or IEC 62368-1 for data processing equipment and IEC 60601-1 for medical equipment). Everybody who connects additional equipment to the signal input part or signal output part configures a medical system, and is therefore responsible that the system complies with the requirements of IEC 60601-1. If in doubt, consult the nearest J. MORITA OFFICE, its representative or its dealer for help.
- * Some of the following devices may cause some technical problems with the Veraviewepocs. Ask your nearest J. MORITA OFFICE for proper selection of equipment and connections.

CAUTION

The following devices may not be located in the X-ray protection area or the patient vicinity except the Hub if the Hub is conformed with IEC60601-1, IEC60950-1, or IEC 62368-1 and enclosure leakage current is conformed with IEC 60601-1.

- * The patient vicinity is the area where intentional or unintentional contact can occur between a patient or a patient's attendant and the above devices, or between a patient or a patient's attendant and other persons touching the above devices. This area extends 1.83 m beyond the perimeter of the bed (examination table, dental chair, treatment booth, and the like) in its intended location, and vertically 2.29 m above the floor.

WARNING

- *Connect only items that have been specified as part of medical electric system or specified as being compatible with medical electric system.*
- *Do not use multiple portable socket outlet nor extension cord for the system power supply.*

- * Computers or any other external devices must be connected in accordance with IEC 60601-1.
- * Computers or any other external devices must be cleaned in accordance with the manufacturer's instructions.
- * Computers or any other external devices must be transport, storage, and operation in accordance with the manufacturers' instructions.

Other System Requirements

Hardware

Windows based Personal Computer (Minimum specifications)	
Operating system:	Microsoft Windows 7, 32 bit with Service Pack 2.
CPU:	Intel Xeon or higher, or compatible.
Memory:	RAM minimum 4 GB
HDD:	HDD 100 GB or more are recommended.
Video board:	Video capture board resolution of 1024 × 768 and color depth of 24bit
Network protocol:	TCP/IP with static IP address.
Network interface:	Universal 10BASE-T Ethernet NIC for internal connection
Others:	Network board, DVD drive.
Monitor:	17 inch TFT LCD 16 million colors 1024 × 768 pixels or better
Standard:	IEC60950-1, IEC 62368-1, or IEC60601-1 EMD regulation Related UL standard (addition to USA) Related C-UL standard (addition to Canada) Local regulations

Hub

Specifications	1000BASE-T compatible 5 ports or more Jumbo Frame (Packet) supported.
Standard:	IEC60950-1 or IEC 62368-1 if it is used in non patient vicinity IEC60601-1 or IEC60950-1 or IEC 62368-1 with leakage current conformed with IEC 60601-1. EMD regulation Related UL standard (addition to USA) Related C-UL standard (addition to Canada) IEEE802.3x Local regulations
Recommended for example:	Buffalo LSW3-GT-5EP/CW

Network Interface Card

Model:	Intel PRO/1000 GT Desktop Adapter No other model supported
--------	---

Storage Devices

Standard:	DVD-R disk drive is recommended. IEC60950-1 or IEC 62368-1 if it is used in non patient vicinity EMD regulation Related UL standard (addition to USA) Related C-UL standard (addition to Canada) Local regulations
-----------	---

Other equipment connected to PC

Standard:	IEC60950-1 or IEC 62368-1 if it is used in non patient vicinity EMD regulation Related UL standard (addition to USA) Related C-UL standard (addition to Canada) Local regulations
-----------	---

Application Software

Application software i-Dixel provided by J. MORITA MFG. CORP is used to process and view the images.
It shall be used with an Windows based computer matching to the above mentioned specifications.

Environmental Data

Operating Conditions

Temperature	+10°C to +35°C (+50°F to +95°F)
Humidity	30% to 70% (without condensation)
Atmospheric Pressure	70 kPa to 106 kPa

Transport and Storage Conditions

Temperature	-10°C to +50°C (+14°F to +122°F)
Humidity	20% to 70% (without condensation)
Atmospheric Pressure	70 kPa to 106 kPa

Original Language

English

Disposal

The package should be recycled. Metal parts of the equipment are disposed as scrap metal. Synthetic materials, electrical components, and printed circuit boards are disposed as electrical scrap. Material must be disposed according to the relevant national legal regulations. Consult specialized disposal companies for this purpose. Please inquire of the local city/community administrations concerning local disposal companies.



This symbol indicates that the waste of electrical and electronic equipment must not be disposed as unsorted municipal waste and must be collected separately. Contact your local dealer or J. MORITA OFFICE for details.

Tube Housing Assembly Heating Curve

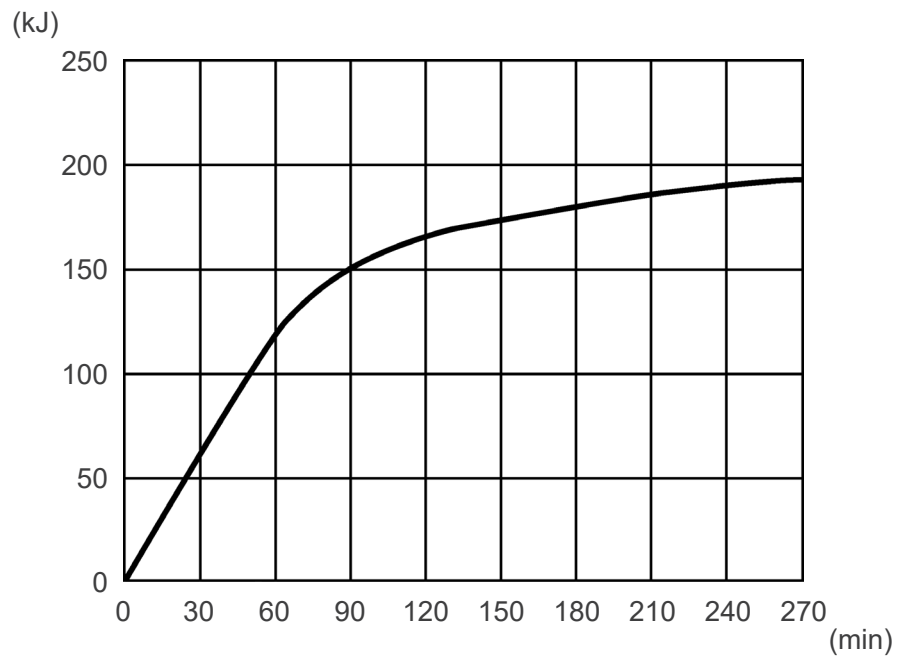

Tube Housing Assembly Cooling Curve

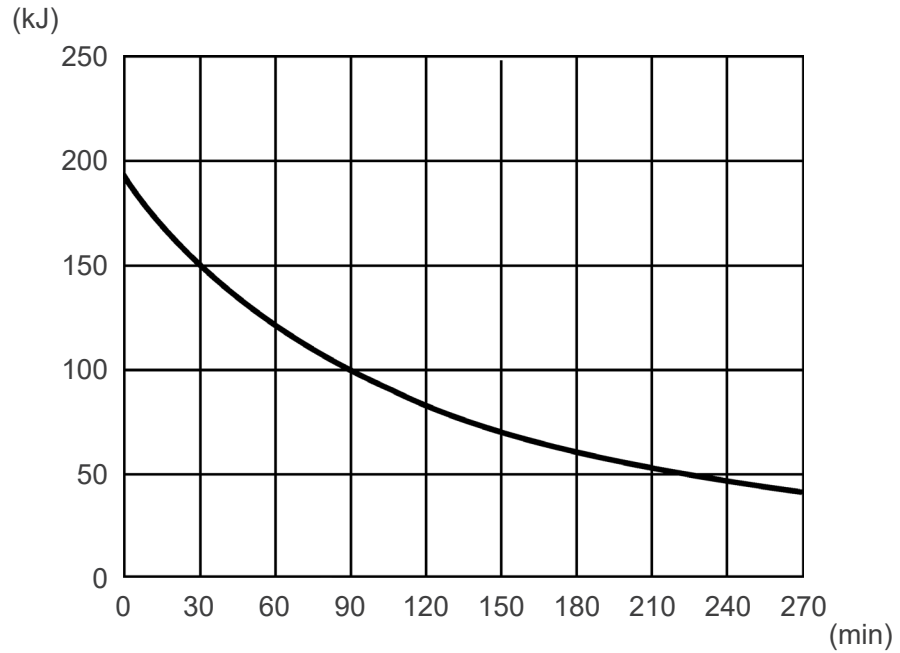

Tube Rating Chart

Tube rating chart
 Maximum Rating Chart
 (Absolute Maximum Rating Charts)

D-051

DC
 Focal Spot: 0.5mm

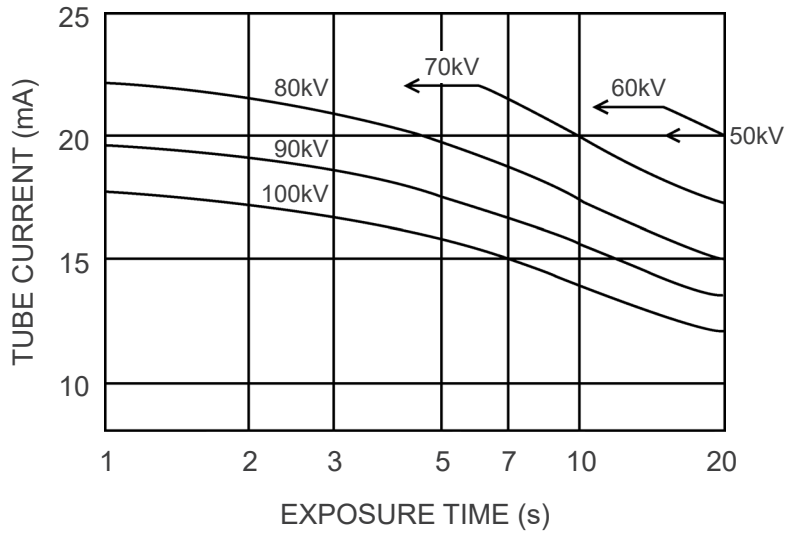

Anode Thermal Characteristics

Anode Thermal Characteristics
D-051

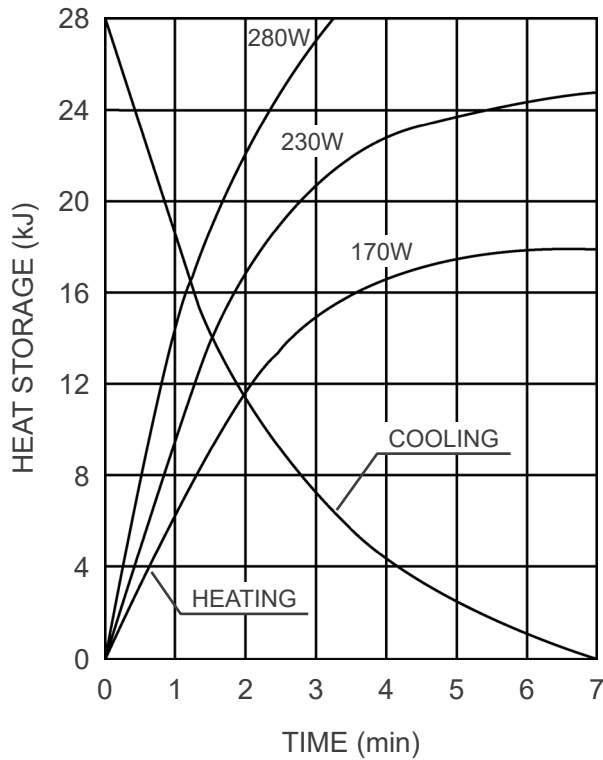

Reference Axis

Panoramic

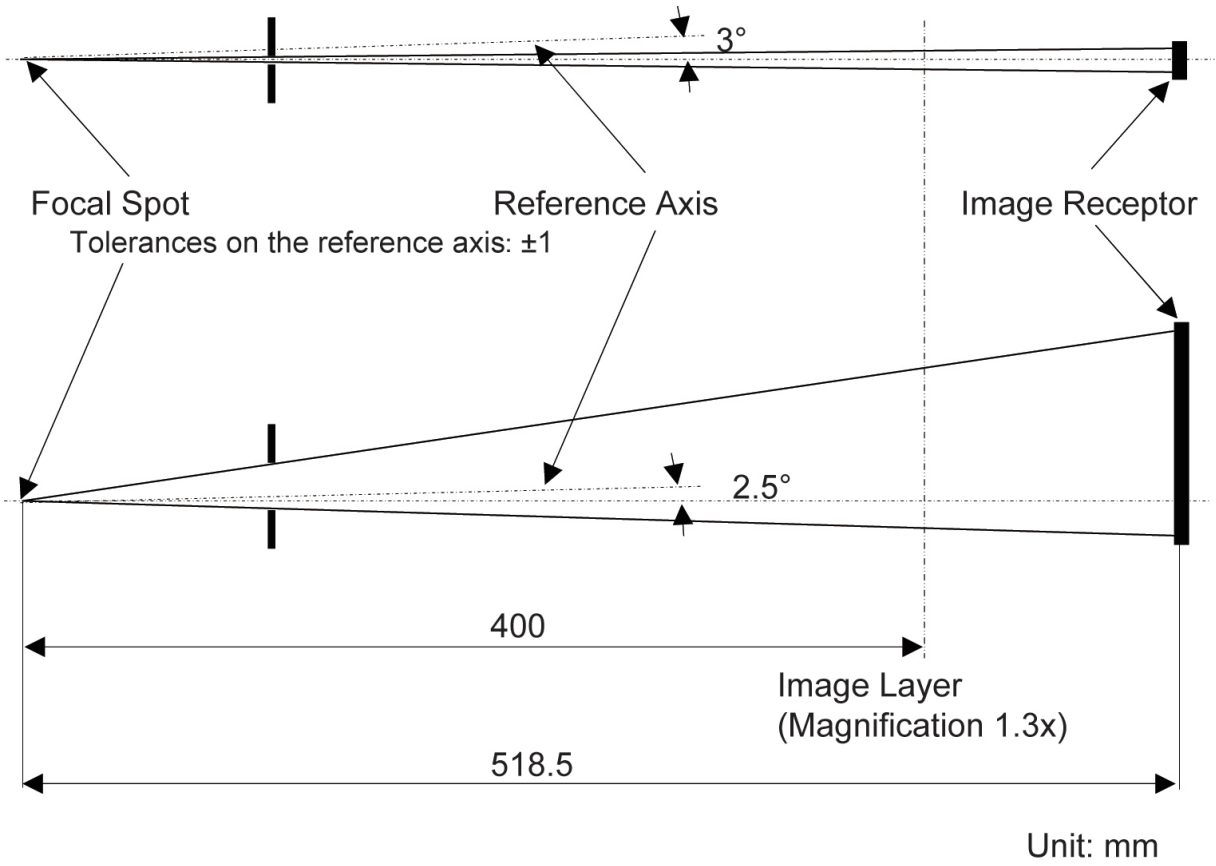

Cephalometric

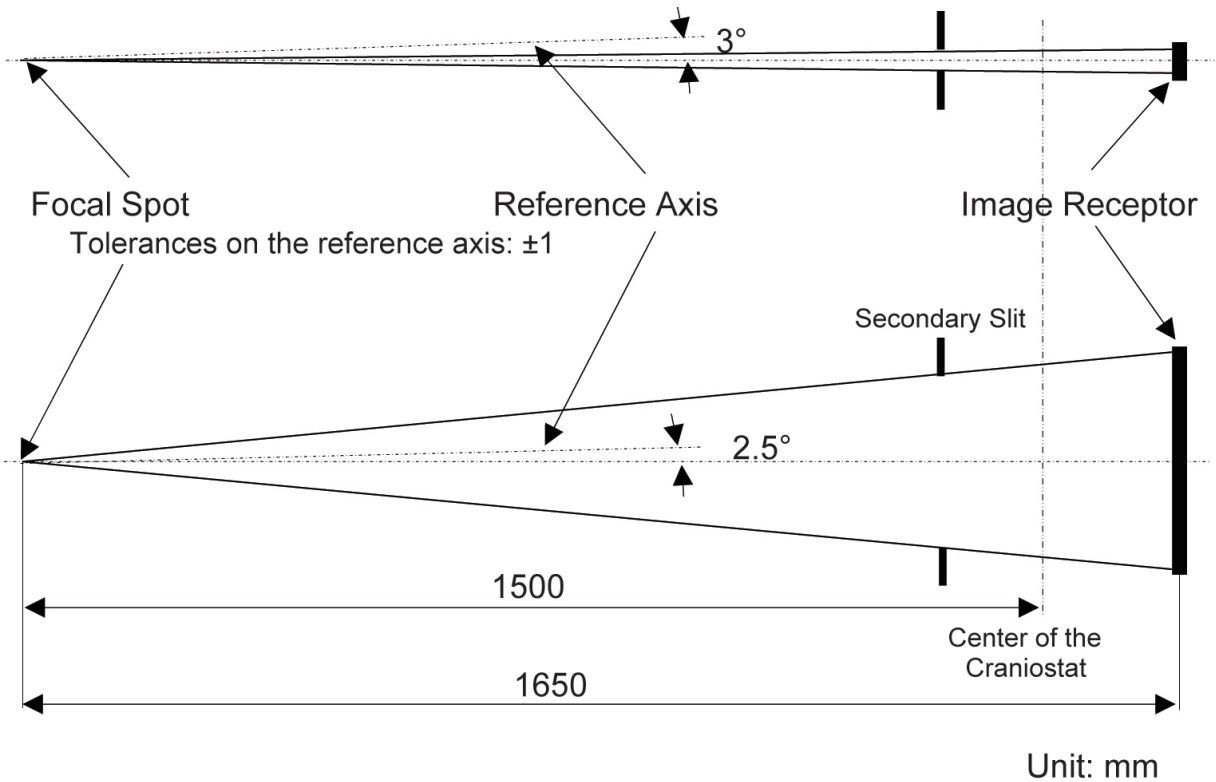

CT
FPV: 40×40, 40×80

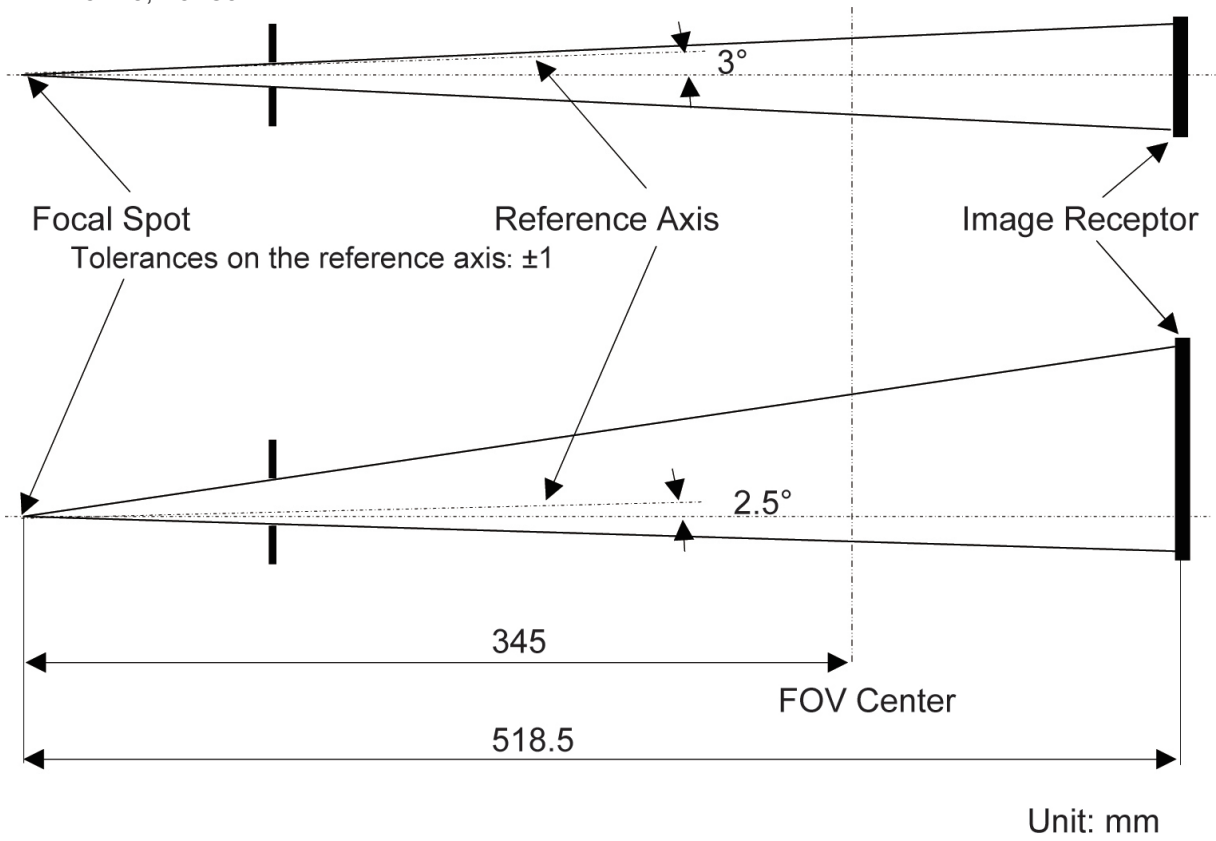

CT
FPV: 80×50, 80×80, 100×50, 100×80

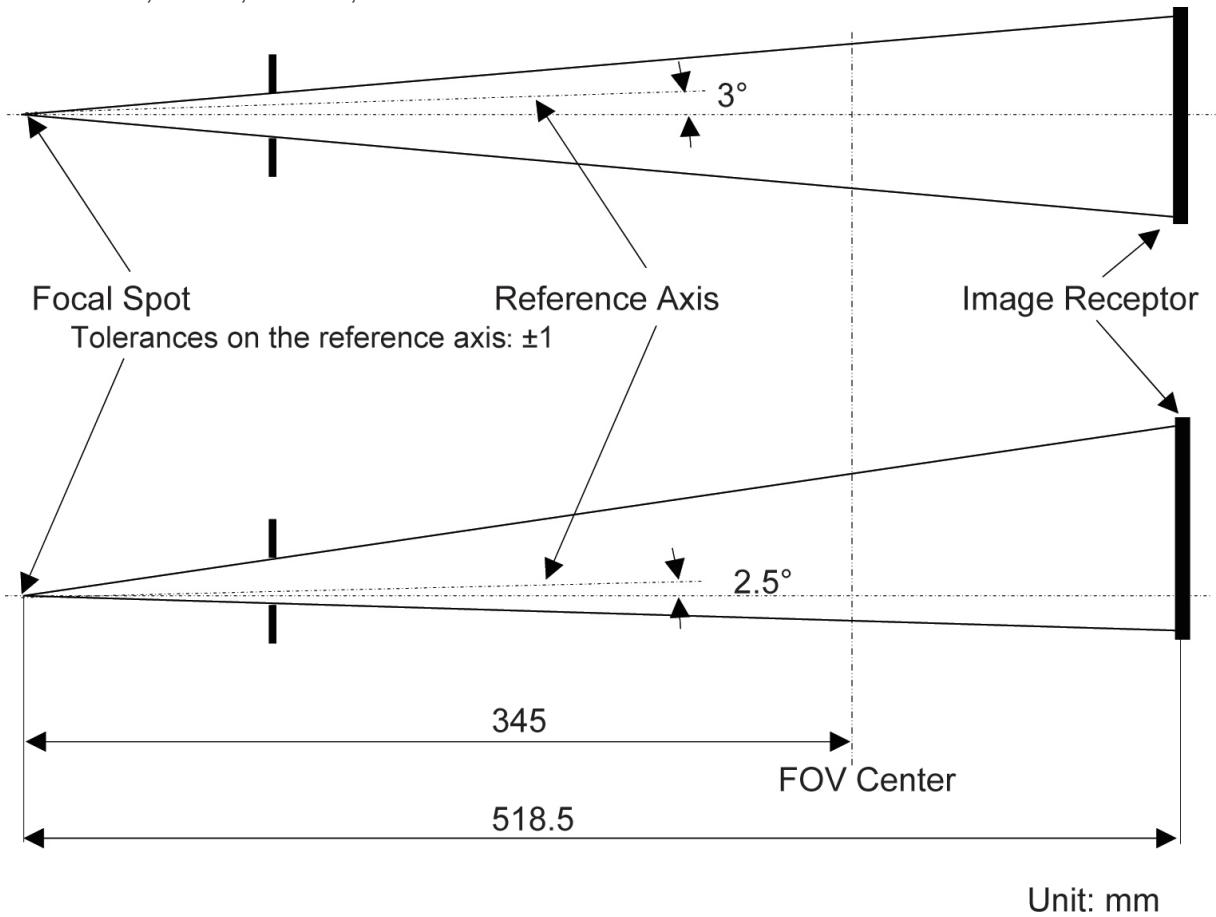

2. Symbols and Markings

* Some symbols may not be used.



Laser Radiation



Laser Cautions Label (EX-1)



Laser Cautions Label (EX-1)



Laser Cautions Label (EX-2)

Caution Label (EX-1)



Before operating the panel, make sure the patient's hand or fingers are not inserted into any gaps between moving parts to avoid injury.

Antes de operar el panel, asegúrese de que la mano o los dedos del paciente no están insertos en ninguna ranura de manera que evite heridas.

Avant d'utiliser le tableau et afin de prévenir tout risque de blessure, assurez-vous que les mains et les doigts du patient ne se trouvent pas dans les espaces situés entre les pièces mobiles.

Caution Label (EX-2)



Before operating the panel, make sure the patient's hand or fingers are not inserted into any gaps between moving parts to avoid injury.

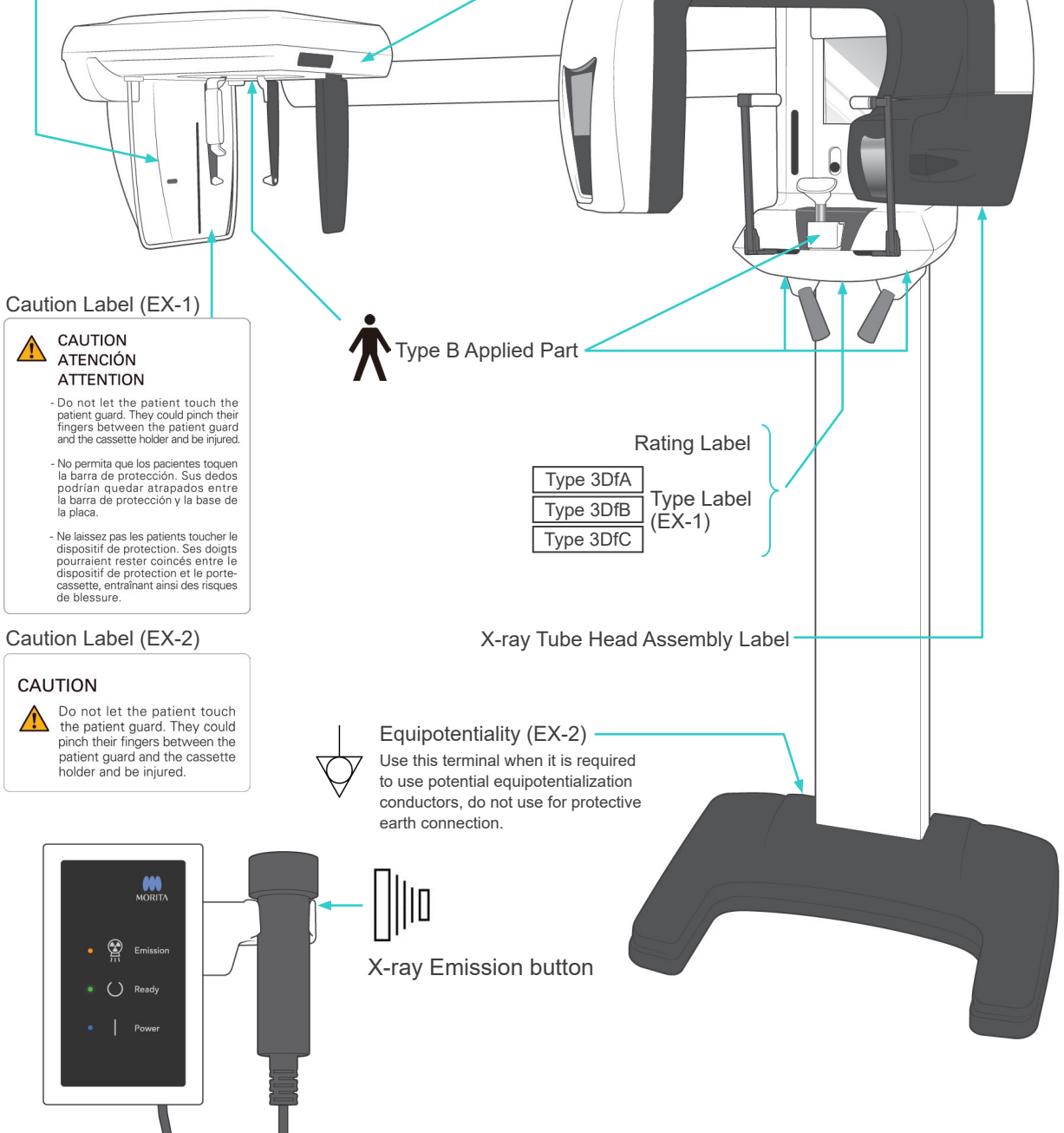

Caution Label (EX-1)

CAUTION
ATENCIÓN
ATTENTION

- Do not let the patient touch the patient guard. They could pinch their fingers between the patient guard and the cassette holder and be injured.
- No permita que los pacientes toquen la barra de protección. Sus dedos podrían quedar atrapados entre la barra de protección y la base de la placa.
- Ne laissez pas les patients toucher le dispositif de protection. Ses doigts pourraient rester coincés entre le dispositif de protection et le porte-cassette, entraînant ainsi des risques de blessure.

Caution Label (EX-2)

CAUTION

CAUTION

Do not let the patient touch the patient guard. They could pinch their fingers between the patient guard and the cassette holder and be injured.

NOTICE
The audible signal, which is installed in Control Box, is active when X-ray is emitted and is deactivated when X-ray is terminated.

Tube Voltage

Range: 60 - 80 kV (For Panoramic or CT)
Range: 60 - 90 kV (For Cephalometric)
Accuracy: ±10% of Selected Value

Tube Current

Range: 1 - 10 mA
Accuracy: ±10% of Selected Value
Cephalometric LA with density mode and CT with DR MODE apply ±10% of Programmed Value

Exposure Timer

Accuracy: ±10% of Selected Value

Automatic Exposure Setting

The factory default setting of the Auto Level is zero. Exposure Levels are shown in the table below.

Auto Level Selection	Exposure Level (%)
+4	286
+3	220
+2	169
+1	130
+0	100
-1	77
-2	59
-3	46
-4	35

WARNING

This X-ray unit may be dangerous to patient and operator unless safe exposure factors, operating instructions and maintenance schedules are observed.

Explosion hazard: Do not use in presence of flammable anesthetics.

ADVERTENCIA

Este aparato radiográfico puede ser peligroso para el paciente y el operador si no se siguen los factores de exposición de seguridad, las instrucciones de operación y el horario de mantenimiento.

Peligro de explosión: No lo utilice cerca de sustancias anestésicas inflamables.

MISE EN GARDE

Cet appareil à rayons X peut présenter un danger pour le patient et l'opérateur, si les facteurs d'expositions qui ne présentent pas de danger, les instructions d'emploi et les programmes d'entretien ne sont pas respectés.

Risque d'explosion : ne pas utiliser en présence d'anesthésiants inflammables.



**CAUTION: X-RAYS-
ATTENTION: RAYONS X
WARNING—MISE EN GARDE:**

- Any unauthorized use is prohibited.
- Hazardous X-rays are emitted when the equipment is in operation.
- Toute utilisation non autorisée est interdite.
- Lorsque l'équipement est en service, il émet des rayons X dangereux.



**- CAUTION LASER, TO AVOID
EYE DAMAGE DO NOT LOOK
INTO BEAM
- ATTENTION LASER, POUR
ÉVITER DES DOMMAGES AUX
YEUX NE PAS REGARDER DANS
LE FAISCEAU**

X710-95062-501

Warning Label (EX-1)

Audible Signal and Accuracy Label (EX-1)

X-ray Warning Symbol and Statements (EX-1)



Main Switch
I : On
O : Off



Emergency Stop

Focal Spot (dimple)



Laser Radiation



Laser Caution Label (EX-2)



Laser Caution Label (EX-1)



Laser Caution Label (EX-1)

Caution Label (EX-1)



Before operating the panel, make sure the patient's hand or fingers are not inserted into any gaps between moving parts to avoid injury.

Antes de operar el panel, asegúrese de que la mano o los dedos del paciente no están insertos en ninguna ranura de manera que evite heridas.

Avant d'utiliser le tableau et afin de prévenir tout risque de blessure, assurez-vous que les mains et les doigts du patient ne se trouvent pas dans les espaces situés entre les pièces mobiles.

Caution Label (EX-2)



Before operating the panel, make sure the patient's hand or fingers are not inserted into any gaps between moving parts to avoid injury.

Package



This way up



Fragile



Keep away from rain



Temperature limitation



Humidity limitation



Atmospheric pressure limitation



Attention, consult accompany documents



Do not reuse

Rx Only

Prescription Device
CAUTION: Federal law restricts this device to sale by or on the order of a dentist and a licensed healthcare practitioner.
(Valid only for U.S.A.)



(Examples)

Country or region
(Country Names: Conforming to the ISO 3166-1 alpha-3 codes and EU for European Union)
Description noted next to the code is an indication that conforms to the regulations valid only for the relevant country or region.

QTY.



Packaging unit



Importer



Distributor

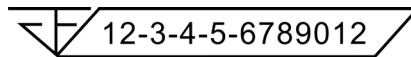

Registration number of medical device in Thailand
(The 12-digit sample number shown is for demonstration purposes only.)

Rating Label, X-ray Tube Head Assembly Label, and Instructions for Use



Serial number



Manufacturer



Date of manufacture



GS1 DataMatrix



Medical device



Unique device identifier



Alternating current



Refer to instructions for use



(Examples)

Country or region
(Country Names: Conforming to the ISO 3166-1 alpha-3 codes and EU for European Union)
Description noted next to the code is an indication that conforms to the regulations valid only for the relevant country or region.



CE(0197) marking (Valid only for EU)
Conforms with the European Directive, 93/42/EEC.
CE marking (Valid only for EU)
Conforms with the European Directive, 2011/65/EU.



EU authorized representative under the European Directive 93/42/EEC
(Valid only for EU)



Marking of electrical equipment in accordance with the European Directive 2012/19/EU (WEEE)
(Valid only for EU)



cTUVus certification mark
(Valid only for U.S.A. and Canada)



Consult instructions for use



Authorized representative in Switzerland

Indicated Items on the Rating Label and X-ray Tube Head Assembly Label

- * For details, refer to “Technical Specifications” (p.146).
- * Some symbols described on the previous page may be included.

Rating Label

Model: Model of X-ray system

Type: Type

Input: Rated input voltage, frequency, and power in operation

Standby: Input power in standby

Duty Cycle: Duty cycle of X-ray system

2D barcode at bottom right: Label code

X-ray Tube Head Assembly Label

MODEL: Model of tube housing assembly

RATING: Rated output of tube housing assembly

HEAD NO.: Serial number of tube housing assembly

DATE OF MFG.: Date of manufacture

TOTAL FILTRATION: Min. inherent filtration

ADDITIONAL FILTRATION FOR CT: Added filtration for CT

TUBE MODEL: Model of X-ray tube

TUBE ANODE NO.: Serial number of X-ray tube

NOMINAL FOCAL SPOT: Nominal focal spot value

MFD. BY: Manufacturer of X-ray tube

Electromagnetic Disturbances (EMD)

The Veraviewepocs 3D (Model: X550, hereafter “this device”) conforms to IEC 60601-1-2 Edition 4.1, the relevant international standard for electromagnetic disturbances (EMD).

Use Environment

The use environment of this device is the Professional healthcare facility environment.

WARNING

- *Use of this device adjacent to or stacked with other equipment should be avoided because it could result in improper operation. If such use is necessary, this device and the other equipment should be observed to verify that they are operating normally.*
- *Use of accessories, transducers and cables other than those specified or provided by us could result in increased electromagnetic emissions or decreased electromagnetic immunity of this device and result in improper operation.*
- *Portable RF communications equipment (including peripherals such as antenna cables and external antennas) should be used no closer than 30 cm (12 inches) to any part of the X550, including cables specified by the manufacturer. Otherwise, degradation of the performance of this device could result.*
- *RFID readers and electronic article surveillance (EAS) systems should not be near from any part of the X550.*

Compliance for Each EMISSIONS and IMMUNITY Standards

Emissions Test	Compliance	Electromagnetic Environment – Guidance
Conducted disturbance CISPR 11	Group 1 Class B	This device is suitable for use in all establishments, including domestic establishments and those directly connected to the public low-voltage power supply network that supplies buildings used for domestic purposes.
Radiated disturbance CISPR 11	Group 1 Class B	
Harmonic current IEC 61000-3-2	Class A	
Voltage fluctuations and flicker IEC 61000-3-3	Clause 5	

Immunity Test	IEC 60601 Test Level	Compliance Level	Electromagnetic Environment – Guidance
Electrostatic discharge (ESD) IEC 61000-4-2	±8 kV contact ±2 kV, ±4 kV, ±8 kV, ±15 kV air	±2 kV, ±4 kV, ±6 kV, ±8 kV contact ±2 kV, ±4 kV, ±8 kV, ±15 kV air	Floors should be wood, concrete or ceramic tile. If floors are covered with synthetic material, the relative humidity should be at least 30%.
Electrical fast transients/bursts IEC 61000-4-4	±2 kV for power supply lines ±1 kV for input/output lines	±2 kV for power supply lines ±1 kV for input/output line	Mains power quality should be that of a typical commercial or hospital environment.
Surge IEC 61000-4-5	<u>AC/DC power</u> ±0.5 kV, ±1 kV line(s) to line(s) ±0.5 kV, ±1 kV, ±2 kV line(s) to earth <u>Signal input/output</u> ±2 kV line(s) to earth	<u>AC/DC power</u> ±0.5 kV, ±1 kV line(s) to line(s) ±0.5 kV, ±1 kV, ±2 kV line(s) to earth <u>Signal input/output</u> *1 ±2 kV line(s) to earth	Mains power quality should be that of a typical commercial or hospital environment.
Voltage dips, short interruptions and voltage variations on power supply lines IEC 61000-4-11	<u>dips</u> 0% U_T : 0.5 cycle (at 0, 45, 90, 135, 180, 225, 270, 315°) 0% U_T : 1 cycle (at 0°) 70% U_T : 25/30 cycles (at 0°) 25 (50 Hz)/30 (60 Hz) <u>short interruptions</u> 0% U_T : 250/300 cycles 250 (50 Hz)/300 (60 Hz)	<u>dips</u> 0% U_T : 0.5 cycle (at 0, 45, 90, 135, 180, 225, 270, 315°) 0% U_T : 1 cycle (at 0°) 70% U_T : 25/30 cycles (at 0°) 25 (50 Hz)/30 (60 Hz) <u>short interruptions</u> 0% U_T : 250/300 cycles 250 (50 Hz)/300 (60 Hz)	Mains power quality should be that of a typical commercial or hospital environment. If user of this device requires continued operation during power mains interruptions, it is recommended that this device be powered from an uninterruptible power supply or a battery.
Power frequency (50/60 Hz) magnetic field IEC 61000-4-8	30 A/m (r.m.s.) 50 Hz or 60 Hz	30 A/m (r.m.s.) 50 Hz or 60 Hz	Power frequency magnetic field should be at levels characteristic of a typical location in a typical commercial or hospital environment.
Proximity magnetic fields IEC61000-4-39	<u>30 kHz</u> CW, 8 A/m <u>134.2 kHz</u> 2.1 kHz, 65 A/m <u>13.56 MHz</u> 50 kHz, 7.5 A/m	<u>30 kHz</u> CW, 8 A/m*2 <u>134.2 kHz</u> 2.1 kHz, 65 A/m*3 <u>13.56 MHz</u> 50 kHz, 7.5 A/m*3	The proximity magnetic field should be at a level characteristic of magnetic fields emitted from RFID, IH (Induction Heating), etc.
NOTE 1: U_T is the a.c. mains voltage prior to application of the test level. NOTE 2: r.m.s.: root mean square			

*1: Not applicable because it does not connect directly to outdoor cable.

*2: This test is not applicable since this device is not intended for use in the HOME HEALTHCARE ENVIRONMENT.

*3: This test is not applicable since this device does not use a circuit that is sensitive to magnetic fields, such as a Hall element or a magnetic resistance element.

Immunity Test	IEC 60601 Test Level	Compliance Level	Electromagnetic Environment – Guidance
Conducted RF IEC 61000-4-6	3 V ISM ^(c) / amateur radio frequency band: 6 V 150 kHz to 80 MHz	3 V ISM ^(c) / amateur radio frequency band: 6 V 150 kHz to 80 MHz	<p>Portable and mobile RF communications equipment should be used no closer to any part of this device, including cables, than the recommended separation distance calculated from the equation applicable to the frequency of the transmitter.</p> <p>Recommended separation distances</p> $d = 1.2 \sqrt{P}$ $d = 1.2 \sqrt{P}$ $d = 2.3 \sqrt{P}$ $d = \frac{6}{E} \sqrt{P}$ <p>150 kHz to 80 MHz 80 MHz to 800 MHz 800 MHz to 2.7 GHz</p> <p>Portable wireless RF communication equipment</p> <p>Where P is the maximum output power rating of the transmitter in watts (W) according to the transmitter manufacturer, E is the compliance level in V/m and d is the recommended separation distance in meters (m).</p> <p>Field strengths from field RF transmitters, as determined by an electromagnetic site survey^(a), should be less than the compliance level in each frequency range^(b).</p> <p>Interference may occur in the vicinity of equipment marked with the following symbol:</p> 
Radiated RF IEC 61000-4-3	3 V/m 80 MHz to 2.7 GHz	3 V/m 80 MHz to 2.7 GHz	
	27 V/m 385 MHz	27 V/m 385 MHz	
	28 V/m 450 MHz	28 V/m 450 MHz	
	9 V/m 710, 745, 780 MHz	9 V/m 710, 745, 780 MHz	
	28 V/m 810, 870, 930, MHz	28 V/m 810, 870, 930, MHz	
	28 V/m 1720, 1845, 1970 MHz	28 V/m 1720, 1845, 1970 MHz	
	28 V/m 2450 MHz	28 V/m 2450 MHz	
	9 V/m 5240, 5500, 5785 MHz	9 V/m 5240, 5500, 5785 MHz	

NOTE 1: At 80 MHz and 800 MHz, the higher frequency range applies.

NOTE 2: These guidelines may not apply in all situations. Electromagnetic propagation is affected by absorption and reflection from structures, objects and people.

- ^(a) Field strengths from fixed transmitters, such as base stations for radio (cellular/cordless) telephones and land mobile radios, amateur radio, AM and FM radio broadcast and TV broadcast cannot be predicated theoretically with accuracy. To assess the electromagnetic environment due to fixed RF transmitters, an electromagnetic site survey should be considered. If the measured field strength in the location in which this device is used exceeds the applicable RF compliance level above, this device should be observed to verify normal operation. If abnormal performance is observed, additional measures may be necessary, such as reorienting or relocating this device.
- ^(b) Over the frequency range 150 kHz to 80 MHz, field strengths should be less than 3 V/m.
- ^(c) The ISM (Industrial, Scientific and Medical) bands between 0.15 MHz and 80 MHz are 6.765 MHz to 6.795 MHz; 13.553 MHz to 13.567 MHz; 26.957 MHz to 27.283 MHz; and 40.66 MHz to 40.70 MHz.

Pass/Fail Criteria on Immunity Test

- No X-ray irradiation without active operation of the emission button.
- X-ray termination with release of the emission button.
- No unexpected movement of the equipment.

NOTE:

If the essential performance is lost or degraded due to electromagnetic disturbance, unexpected movement would be initiated without any active of operation, or X-ray termination would not be done by releasing the Emission switch, or X-ray would be irradiated without an active operation of the Emission switch.



Development and Manufacturing

J. MORITA MFG. CORP.

680 Higashihama Minami-cho, Fushimi-ku, Kyoto 612-8533, Japan
T +81. (0)75. 611 2141, F +81. (0)75. 622 4595

Morita Global Website
www.morita.com

Distribution

J. MORITA CORP.

3-33-18 Tarumi-cho, Suita-shi, Osaka 564-8650, Japan
T +81. (0)6. 6380 1521, F +81. (0)6. 6380 0585

J. MORITA USA, INC.

9 Mason, Irvine CA 92618, USA
T +1. 949. 581 9600, F +1. 949. 581 8811

J. MORITA EUROPE GMBH

Justus-von-Liebig-Strasse 27b, 63128 Dietzenbach, Germany
T +49. (0)6074. 836 0, F +49. (0)6074. 836 299

MORITA DENTAL ASIA PTE. LTD.

150 Kampong Ampat #06-01A KA Centre, Singapore 368324
T +65. 6779. 4795, F +65. 6777. 2279

J. MORITA CORP. AUSTRALIA & NEW ZEALAND

Suite 2.05, 247 Coward Street, Mascot NSW 2020, Australia
T +61. (0)2. 9667 3555, F +61. (0)2. 9667 3577

J. MORITA CORP. MIDDLE EAST

4 Tag Al Roasaa, Apartment 902, Saba Pacha 21311 Alexandria, Egypt
T +20. (0)3. 58 222 94, F +20. (0)3. 58 222 96

J. MORITA CORP. INDIA

Filix Office No.908, L.B.S. Marg, Opp. Asian Paints, Bhandup (West), Mumbai 400078, India
T +91-82-8666-7482

J. MORITA MFG. CORP. INDONESIA

28F, DBS Bank Tower, Jl. Prof. Dr. Satrio Kav. 3-5, Jakarta 12940, Indonesia
T +62-21-2988-8332, F + 62-21-2988-8201

SIAMDENT CO., LTD.

71/10 Moo 5 T. Tharkham A. Bangpakong Chachuengsao 24130 Thailand
T +66 (0) 3857 3042, F +66 (0) 3857 3043
www.siamdent.com

EU Authorized Representative under the European Directive 93/42/EEC



Medical Technology Promedt Consulting GmbH

Ernst-Heckel-Straße 7, 66386 St. Ingbert, Germany T +49. 6894 581020, F +49. 6894 581021

The authority granted to the authorized representative, Medical Technology Promedt Consulting GmbH, by J. MORITA MFG. CORP. is solely limited to the work of the authorized representative with the requirements of the European Directive 93/42/EEC for product registration and incident report.

Diagnostic and Imaging Equipment

Treatment Units

Handpieces and Instruments

Endodontic Systems

Laser Equipment

Laboratory Devices

Educational and Training Systems

Auxiliaries